

profili per fai da te / ceramica / suolo / sanitario

profili per ceramica / sanitario



**PROFILI  
DI PROTEZIONE  
PER PIASTRELLE  
CERAMICHE**

*Profiles for ceramic tile protection  
Profils de protection pour carreaux de céramique  
Perfiles de protección para azulejos*

**p. 20**



**Acciaio inox e Ottone** p. 22  
Stainless Steel and Brass  
Acier Inoxydable et Laiton  
Acero inoxidable y latón

**Alluminio naturale e  
anodizzato satinato** p. 54  
Raw and satin anodised alu  
Alu naturel et anodisé satiné  
Alu natural y anodizado Satinado

**Alluminio anodizzato lucido** p. 74  
Polished anodised alu  
Alu anodisé brillant  
Alu anodizado brillo

**Alluminio anodizzato  
spazzolato  
e Alluminio verniciato** p. 88-90  
Anodised brushed alu and Powder  
coated alu  
Alu anodisé brossé et Alu verni  
Alu anodizado cepillado y Alu pintado

**Alluminio effetto pietra** p. 104  
Stone finish alu  
Alu effet pierre  
Alu efecto piedra

**PVC satinato** p. 116  
Satin PVC  
PVC satiné  
PVC satinado

**PVC extra lucido** p. 136  
Extra Shiny PVC  
PVC extra brillant  
PVC extra brillante

**PVC rivestito** p. 152  
Coated PVC  
PVC enduit  
PVC Recubierto

**Paraspigoli** p. 158  
Corner profiles  
Protecteur D'angle  
Guardacantos

**Listelli** p. 182  
Decorative listello  
Equerres de finition  
Listeles

**GIUNTI DI  
DILATAZIONE**

*Expansion joints  
Joints de dilatation  
Juntas de expansión*

**p. 190**



**Giunti di dilatazione** p. 192  
Expansion joints  
Joints de dilatation  
Juntas de expansión

**PROFILI  
PER TOP CUCINA**

*Kitchen worktop cover profiles  
Profils pour les plans de travail de cuisine  
Perfiles para encimeras de cocina*

**p. 198**



**Profili per top cucina** p. 200  
Kitchen worktop cover profiles  
Profils pour les plans de travail  
de cuisine  
Perfiles para encimeras de cocina

**Kit per top cucina** p. 202  
Kitchen worktop cover kit  
Kit pour les plans de travail  
de cuisine  
Kit para encimeras de cocina

**PROFILI DI RACCORDO  
IGIENICO**

*Sanitary-wear profiles  
Profils de connections hygiéniques  
Perfiles de conexión higiénica*

**p. 204**



**Profili di raccordo igienico** p. 206  
Sanitary-wear profiles  
Profils de connections hygiéniques  
Perfiles de conexión higiénica

**DRENAGGIO**

*Drainage  
Drainage  
Drenaje*

**p. 240**



**Canaline di scarico  
a pavimento per doccia** p. 242  
Shower drain channels  
Canaux de vidange de douche  
Canales de drenaje de ducha

**Membrana isolante** p. 246  
Insulating membrane  
Membrane isolante  
Membrana aislante

**Membrana desolidarizzante** p. 248  
Desolidarizing membrane  
Membrane désolidarisante  
Membrana desolidarizadora

**PROFILI  
PER BALCONE**

Balcony profiles  
 Profilés puor Balcon  
 Perfiles para balcón

**p.250**



**Profili eco** p. 252  
 Eco profiles  
 Profilés écologique  
 Perfiles de eco

**Profili verniciati lucidi** p. 254  
 Polished painted profiles  
 Profilés peints poli  
 Perfiles pintados pulidos

**Profili in alluminio effetto  
pietra** p. 260  
 Stone finish painting  
 profiles  
 Profilés effet pierre peinte  
 Perfiles efecto piedra pintada

**Angolare Portaintonaco** p. 266  
 Corner plaster holder  
 Porte-plâtre d'angle  
 Soporte de yeso de esquina

**ACCESSORI  
PER LA POSA**

Accessories for fixing and laying  
 Accessoires de pose  
 Accesorios para la puesta en obra

**p.268**



**Distanziatori  
per piastrelle** p. 270  
 Tile spacers  
 Entretoises de carrelage  
 Espaciadores de azulejos

**Cunei** p. 270  
 Wedge  
 Coin  
 Cuña

**Distanziatori livellanti  
cuneo/tirante** p. 272  
 Levelling clips wedge / clip  
 Clips de mise à niveau coin / clip  
 Clips de nivelación cuña / clip

**Distanziatori livellanti cappuccio  
autoavvitante/tirante** p. 274  
 Levelling clips self-screwing  
 cap / clip  
 Clips de mise à niveau  
 bouchon / clip auto-vissant  
 Clips de nivelación  
 tapa / clip autorroscantes

**Kit magnetico** p. 276  
 Magnetic Kit  
 Trappe de visite  
 kit magnético

**p.282**



**Marketing su misura** p. 288  
 Customized marketing  
 Marketing personnalisé  
 Marketing personalizado

**Soluzioni Espositive** p. 292  
 Displays  
 Présentoirs  
 Expositores



# history / progress

the character is recognized by its profile

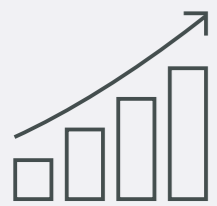

## +57%

increase in turnover over the last 4 years



## +179%

increase in foreign sales over the last 4 years

40 years and more. The story of an all-Italian family and company, dedicated to **tradition** and **constant research**. Because who believes in the future and valuable ideas never quits growing.

Arcansas remained over the years a **family business** despite its strong growth. We're a solid company that can define long-term business goals and freely shape our future. Since 1980 we design, produce and distribute profiles for tillings, hygienic cove, floors and hardware/do-it-yourself on the national and international market.



22.000  
sq m warehouse  
surface

55.000  
sq m total  
surface

## The story of a family



### 1980

Stelio Scriattoli founds **Arcansas Corporation** in Fano (Pu). A small company of 200 sq m, with **5 employees**. His dream? Commercialize on an industrial level profiles for construction and offer the market an innovative product. A winning idea thanks to which the company starts to consolidate its position and in 1984 moves to a larger site of 1000 square meters in Lucrezia (Pu).

### 1989/1990

Thanks to important investments in production technologies and most innovative materials available on the market, absolute innovations are presented in the profile market: **self-adhesive profiles** and profiles produced from profiling machine with **customized packaging**.

### 1991/1992

Stelio passes the helm of the company to his son Amedeo. The company continues to grow and in 1998 it also renews its communication with a rebranding operation: **Arcansas srl** is born.

### 2003/2004

It is the year of the turning point: the company opens to trade its profiles to the **large retail chains** and consolidates its market share in Italy.

### 1994/1995

Arcansas moves to its new 5500 sq m headquarter in Piagge (Pu). Investments in production technologies and the development of the product range continue. The **exclusive patented design of customizable display units for sales points** is introduced.

### 2018/2019

The Piagge plant expands and the production cycle is fully transferred to the new headquarter of Mondavio (Pu). The new **Arcansas warehouse in France** is inaugurated. The product range exceeds **5000 references**. A system for the **total traceability of products** and the **automated management of the warehouse** is introduced. New finishes for aluminum, pvc and stainless steel profiles are presented.

### 2013/2014

The third generation joins the company with Federico, Amedeo's son. **Export exceeds 30% of the turnover**. Arcansas regularly exports to over **34 countries**.

### 2007/2008

Arcansas becomes **leader of the large retail chains for profiles** on the Italian market. The new packaging for metal profiles is presented.

Future plans of the company? Manage fully the production cycle to guarantee our customers always more quality and more control on the finished product.

Amedeo Scriattoli, CEO

certifications /

# protocol

the character is recognized by its profile

We offer a **quality product**, certified and guaranteed thanks to the continuous tests on outgoing products, the exclusive use of first choice materials and full respect of the REACH requirements for the safety of human health and for the environment.

Since 2009 we have obtained various national and international certifications that have allowed to optimize and further improve our processes.

## **OHSAS 18001:2007**

### Safety and workers health management

This standard allows to manage in "an organic and systematic way" the safety of the workers without upsetting the company's organisation structure, improving its performances.

#### **Targets:**

- cancel or minimize the risks/dangers associated to the staff activity
- involve and motivate the staff thanks to trainings, improved and safer working conditions
- Ensure that internal audits are carried out at scheduled intervals, of fitness, adequacy and effectiveness controls

**Year of first issue:** 2010 (annual renewal)

## **ISO 9001:2015 | Quality system**

This internationally recognized standard, is the basis for the implementation of quality systems all over the world, instead of other requirements published in the past.

#### **Targets:**

- Improve credibility and image
- Improve the customer satisfaction
- Improve the processes that create value for the customer in terms of efficiency, elimination of wastefulness and minor number of errors.
- Improve decision-making
- Employees more involved and motivated to generate value

**Year of first issue:** 2003 (three-year renewal)



NORMS	DESCRIPTION
<b>GENERAL REGULATIONS</b>	
2001_95_EC	Directive General product safety
1907_2006_EC	REACH all products
<b>SPECIFIC STANDARDS</b>	
ISO 2813	Paints and varnishes - Determination of specular gloss of non-metallic paint films at 20 degrees, 60 degrees and 85 degrees
ISO 2360	Non-conductive coatings on non-magnetic electrically conductive basis materials
ISO 2409	Paints and varnishes- Cross-cut test
ISO 2815	Paints and varnishes-Buchholz indentation test
ISO 1520	Paints and varnishes-Cupping test
ISO 1519	Paints and varnishes-Bend test (cylindrical mandrel)
ISO 6272-1	Paints and varnishes-Rapid-deformation (impact resistance) tests-Part 1:Fallingweight
ISO 6272-2	Paints and varnishes-Rapid-deformation (impact resistance) tests-Part 2: Fallingweight
ASTM D 2794	Standard Test Method for Resistance of Organic Coatings to the Effects of Rapid
ISO 3231	Paints and varnishes--Determination of resistance to humid atmospheres containing
ISO 4628-2	Paints and varnishes--Evaluation of degradation of coatings--Designation of
ISO 9227	Corrosion tests in artificial atmospheres--Salt spray tests
ISO 16474-1 & 2	Paints and varnishes-Method of exposure to laboratory light sources-Part 1 General
ISO 11664-4	Colorimetry--Part 4: CIE 1976 L*a*b*Colour space
ISO 2810	Paints and varnishes--Natural weathering of coatings--Exposure and assessment
EN 12206-1	Paints and varnishes-Coating of aluminium and alluminium alloys for architectural
ISO 6270-2	Paints and varnishes-Determination of resistance to humidity-Part 2: Procedure for
ISO 4623-2	Paints and varnishes-Determination of resistance to filiform corrosion-Part 2 Aluminium substrates
ISO 4628-10	Paints and varnishes-Evaluation of degradation of coatings-Designation of quantity and size of defects, and of intensity of uniform changes in appearance-Part 10 Assessment of degree of filiform corrosion
ISO 10546	Chemical conversion coatings-Rinsed and non rinsed chromate conversion coatings on aluminium and aluminium alloys
ISO 3892	Conversion coatings on metallic materials--Determination of coating mass per unit area-Gravimetric methods
EN 1706	Aluminium and aluminium alloys-Castings-Chemical composition and mechanical
EN 10025	Hot rolled products of structural steels
NF EN 10162	Cold rolled steel sections-Technical delivery conditions-Dimensional and cross-sectional
EN 10305-3	Steel tubes for precision applications-Technical delivery conditions-Part 1:Seamless cold drawn
EN 10027	Designation systems for steel
EN 573	Aluminium and aluminium alloys-Chemical composition and form of wrought products
NF EN 755	Aluminium and aluminium alloys-Extruded rod/bar, tube and profiles-Part 1:technical conditions
EN 12164/12165/12166/12167/12163/1652	Copper and copper alloys
EN ISO 105-A02	Textiles. Tests for colour fastness. Part A02: grey scale for assessing change in colour
ISO 527	Plastics-Determination of tensile properties

TECHNICAL SPECIFICATIONS			
FUNCTION DESCRIPTION	NORMS	REQUEST	CONCERNED PRODUCTS
Directive General product safety	2001_95_EC	Compliance	ALL
REACH all products	1907_2006_EC	Compliance+analysis report	ALL
Substances Mixtures Articles Products Persistent Organic Pollutants POP	850 2004 EC POP	Compliance+analysis report	ALL
SAFETY		No harmful and sharp edges, cutting chips	ALL
FUNCTION DESCRIPTION	NORMS	REQUEST	CONCERNED PRODUCTS
Gloss under 60°	ISO 2813	Matt : 0-30 = > +/- 5 UG Satin : 31-70 = > +/- 7 UG Gloss : 71-100 = > +/- 10 UG	Aluminium coated profile
Coating thickness	ISO 2360/DIN 17611	Depending on coating type	All coated profile
Dry adhesion	ISO 2409	Class 0 for oxide deposition Class 1 for paint/varnish	All coated profile
Hardness-Indentation	ISO 2815	Min 80	Aluminium coated profile
Bend test	ISO 1519	No cracks	All coated profile
Impact test	ISO 6272	No cracks	All coated profile
Acetic acid salt spray (AASS)	ISO 9227	96h min	Aluminium coated profile
Appearance		Must be without scratches, impact, dust, stains, deformation	All coated profile
Colors		Conform to appearance sheet and master sample	All coated profile
Neutral salt spray (NSS)	ISO 9227	96h min	Stainless steel
Adhesives-Peel adhesion properties	NF EN 1939	Please go to Key, p. 14	All taped profiles
Paint and varnish-Determination of resistance to abrasion	EN 7784	250 laps mini with 500g load	All coated profile

TECHNICAL SPECIFICATIONS			
FUNCTION DESCRIPTION	NORMS	REQUEST	CONCERNED PRODUCTS
STEEL not alloyed-Dimension accuracy	EN 10025	According to standard-S235JR	Steel profile
STEEL Drawn cold-Dimensions accuracy	NF EN 10162	According to standard-E235	Steel profile
<b>STEEL PIPES welded and not welded</b>	EN 10305-3	According to standard-S235JR	Steel profile
STAINLESS STEEL	EN 10027	According to standard-304L	Steel profile
ALUMINIUM-Composition and mechanical properties	EN 573	According to standard-Type AW 6060	Aluminium profile
ALUMINIUM PROFILES-Dimensions accuracy	NF EN 755	According to standard	Aluminium profile
BRASS ALLOY-Dimensions accuracy	EN 12164/12165/12166/12167/12163/1652	According to standard	Brass profiles
PVC-UV STABILITY	EN ISO 105-A02	According to standard-PVC	PVC profiles
PVC-Mechanical properties	ISO 527	According to standard	PVC profiles
PVC-Dimension accuracy		+/- 1%	PVC profiles



**Sempre disponibile a magazzino**  
**Always available at stock**  
**Toujours disponibles en stock**  
**Siempre disponibles en depósito**



**Protezione con pellicola**  
 adesiva trasparente o termoretratta per permettere la maggior conservazione del profilo contro raggi UV, polvere e graffi. Ne permette inoltre il prelievo, la manipolazione ed il trasporto senza sporcare le mani e le superfici dell'auto. Si consiglia di rimuovere dopo l'installazione.

**Protective film:** Remove the special adhesive which has been used to protect the profile after installation. Thanks to the protective film that Arcansas provides to its profiles, complete protection against UV rays, dust and scratches is possible. Furthermore, the protective film guarantees an ideal solution for all types of finishes. It is transparent and protects the customer from grease residues that form in the profile.

**Film de protection:** adhésif transparent ou thermo rétractable pour permettre une meilleure conservation du profilé contre les rayons UV, la poussière et les rayures. Il permet également le prélèvement, la manipulation et le transport sans se salir les mains et les surfaces de la voiture. Il est conseillé de le supprimer après l'installation.

**Protección con película:** adhesivo transparente o termorretráctil para una mejor conservación del perfil contra rayos UV, polvo y arañazos. También permite la extracción la manipulación y el transporte sin ensuciar las manos y las superficies del coche. Se recomienda quitar después de la instalación.

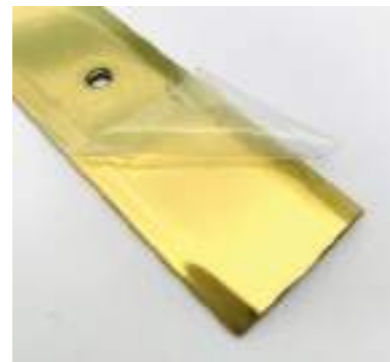
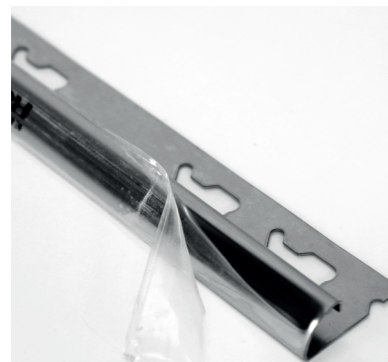

**Nuovo prodotto**  
**New product**  
**Nouveau produit**  
**Nuevo Producto**



**Supporto con foro europeo**  
**Blister with European hole**  
**Blister avec trou européen**  
**Blister con agujero europeo**



**Disponibile su richiesta:** Gli articoli contrassegnati con questo simbolo vengono forniti per quantità minime d'ordine comunicate dall'ufficio commerciale.

**Available on request:** Items marked with this symbol are provided if the minimum order quantities communicated by the sales department are respected.

**Disponibile sur demande:** Les articles marqués de ce symbole sont fournis pour des quantités minimales de commande communiquées par le bureau de vente.

**Disponibile bajo petición:** Los artículos marcados con este símbolo se suministran para cantidades mínimas de pedido comunicadas por la oficina comercial.



**Codice EAN:** a tutti i profili contrassegnati da questo simbolo viene attaccata una etichetta contenente i dati principali per la corretta e certa identificazione del prodotto. I dati indicati sono: tracciabilità completa del prodotto in normativa GS1, codice alfanumerico, descrizione del prodotto, lunghezza, materiale e finitura.

**EAN code:** All profiles marked with this symbol are labelled with correct data for reliable identification of the product for the customer needs. These data are: complete traceability of the product in GS1 regulation, alphanumeric code, product description, length, material and finishing.

**Code EAN:** tous les profilés marqués de ce symbole portent une étiquette contenant les principales données nécessaires à l'identification correcte et certaine du produit. Les données indiquées sont: traçabilité complète du produit dans la norme GS1, code alphanumérique, description du produit, longueur, matériau et finition.

**Código EAN:** a todos los perfiles marcados con este símbolo se adjunta una etiqueta que contiene los datos principales para la correcta y cierta identificación del producto. Los datos indicados son: trazabilidad completa del producto en normativa GS1, código alfanumérico, descripción del producto, longitud, material y acabado.

**Lotto di produzione, codice EAN**

*Production lot, EAN code*

**Famiglia prodotto, codice, sezione**

*Product type, code, section*

**Materiale e misure**

*Material and sizes*

**Indirizzo produttore**

*Manufacturer address*

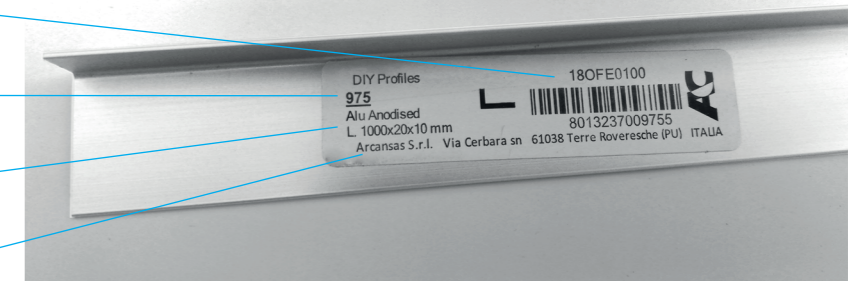

**Foratura:** i fori svasati permettono il perfetto alloggiamento della vite che rimane con la testa allineata al profilo. Le viti fornite sono dello stesso colore del profilo.

**Holes:** Screws fit perfectly with the screwhead laying flush with the surface of the profile, thanks to countersunk holes. The screws supplied are the same color as the profile.

**Perçage:** les trous évasés permettent le logement parfait de la visse qui reste avec la tête alignée au profilé. Les vissees fournies sont de la même couleur que le profilé.

**Taladrado:** los orificios avellanados permiten el alojamiento perfecto del tornillo que permanece con la cabeza alineada al perfil. Los tornillos suministrados son del mismo color que el perfil.

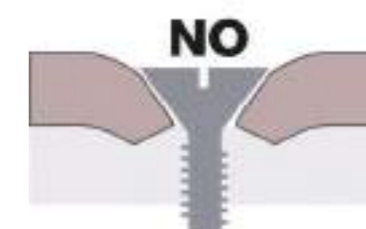
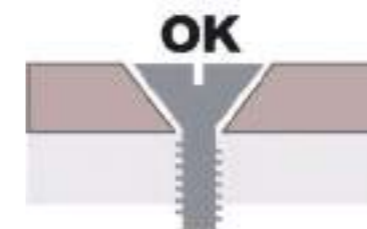



**Adesivo:** del tipo **Hot melt pressure sensitive** applicato a caldo (180°) direttamente sul profilo, è atossico. Può essere utilizzato a qualsiasi temperatura purchè non inferiore a 0°. Dopo l'installazione, l'adesivo diventa impermeabile all'acqua, solventi, detergenti e altri prodotti chimici. Prima dell'applicazione le superfici devono essere pulite ed esenti da grassi e polveri.

**Hot melt pressure sensitive Adhesive:** applied at a temperature of (180°) directly on to the profile and is non-toxic. It can also be used in lower temperatures to 0°. After installation of the profile the adhesive becomes resistant to water, solvents, detergents and other chemicals. Before application, all surfaces must be clean; free from grease and dust particles.

**Adhésif:** type **Hot melt pressure sensitive** appliqué à chaud (180°) directement sur le profilé. Il est non toxique. Il peut être utilisé à n'importe quelle température, à condition qu'elle ne soit pas inférieure à 0°C. Après l'installation, l'adhésif devient imperméable à l'eau, solvants, détergents et autres produits chimiques. Avant l'application, les surfaces doivent être propres et exemptes de matières grasses et de poussière.

**Adhesivo:** del tipo **Hot melt pressure sensitive** aplicado en caliente (180°) directamente sobre el perfil, es atóxico. Puede utilizarse a cualquier temperatura, siempre que no sea inferior a 0°. Tras la instalación, el adhesivo se vuelve impermeable al agua, disolventes, detergentes y otros productos químicos. Antes de su aplicación, las superficies deben estar limpias y exentas de grasa y polvo.



**Adesivo: Nastro biadesivo TESA** garantisce una maggior resistenza ed un'ottima durata nel tempo rispetto al pressure sensitive, le condizioni di uso possono essere verificate nella rispettiva tabella riportata di seguito.

**Adhesive: TESA double-sided tape** guarantees greater resistance and excellent durability over time compared to pressure sensitive, the conditions of use can be checked in the respective table below.

**Adhésif: Ruban adhésif double face TESA** garantit une plus grande résistance et une très bonne durée de vie par rapport à la pression sensitive, les conditions d'utilisation peuvent être vérifiées dans le tableau reporté ci-dessous.

**Adhesivo: Cinta adhesiva biadhesiva TESA** garantiza una mayor resistencia y una óptima duración en el tiempo respecto a las prensas sensitivas, las condiciones de uso se pueden verificar en la respectiva tabla a continuación.

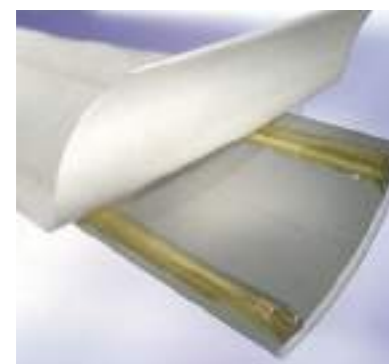

**Adhesive Tape Technical Data:**

Temperature resistance short term	200 °C
Temperature resistance long term	100 °C
Tack	●●●
Ageing resistance (UV)	●●●●
Humidity resistance	●●●●
Resistance to chemicals	●●●
Softener resistance	●●●
Static shear resistance at 23°C	●●●
Static shear resistance at 40°C	●●●

●●●● very good ●●● good ●● medium ● low

**MISURE**

Informazioni, disegni e dati dimensionali contenuti nel presente listino riportano misure nominali. Le illustrazioni fotografiche sono soggette a variazione di colorazione rispetto alla realtà dovute alla stampa.

**SIZES**

Information, drawings and dimensional data in this price list are nominal. Colours in photographs may not correspond to the actual colours due to printing factors.

**MESURES**

Les informations, dessins et les dimensions contenus dans cette liste sont des mesures nominales. Les illustrations photographiques peuvent subir des variations de couleur dues à l'impression.

**MEDIDAS**

La información, los dibujos y los datos dimensionales contenidos en esta lista incluyen medidas nominales. Las ilustraciones fotográficas están sujetas a variaciones de color con respecto a la realidad debido a la impresión.

**AVVERTENZE**

I profili Arcansas non necessitano di particolari manutenzioni e sono facilmente pulibili con alcool o mediante l'impiego di normali detergenti non a base acida. Si consiglia di impiegare spugne e/o panni non abrasivi per evitare di graffiare e/o danneggiare l'anodizzazione, la brillantatura, la verniciatura e la finitura. La resistenza agli agenti chimici dipende dal grado di aggressione e quindi è necessario assicurarsi in maniera preventiva dagli effetti dei prodotti impiegati per la pulizia, per la posa e la manutenzione. Calce, malte e adesivi per piastrelle possono provocare delle macchie sulla superficie a vista dei profili. E' quindi indispensabile pulire tali parti subito dopo la posa in opera.

**IMPORTANT NOTES**

Arcansas profiles do not require particular maintenance and are easily cleaned with alcohol or by using normal non-acid-based detergents. It is recommended to use non-abrasive sponges and / or cloths to avoid scratching and / or damaging the anodizing, brightening, painting and finishing. Resistance to chemical agents depends on the degree of aggression and therefore it is necessary to preventively ensure the effects of the products used for cleaning, laying and maintenance. Lime, mortar and tile adhesives can cause stains on the visible surface of the profiles. It is therefore essential to clean these parts immediately after installation.



**Blisteratura:** confezione termoretratta trasparente, resistente e appropriata per l'esposizione dei profili nell'espositore. Contiene istruzioni per la corretta applicazione del profilo.

**Blistering:** transparent, resistant and heat-shrink packaging for appropriate display of profiles. It contains instructions for the correct application of the profile.

**Blister:** emballage thermorétractable transparent, résistant et approprié pour l'exposition des profilés dans le présentoir. Il contient des instructions pour l'application correcte du profilé.

**Blisteratura:** envase termorretráctil transparente, resistente y adecuado para la exposición de los perfiles en el expositor. Contiene instrucciones para la correcta aplicación del perfil.

**Applicazione profilo**

*Profile application*

**Materiale e sezione**

*Material and section*

**Sistema di fissaggio**

*Fixing system*

**Codici e misure**

*Codes and sizes*

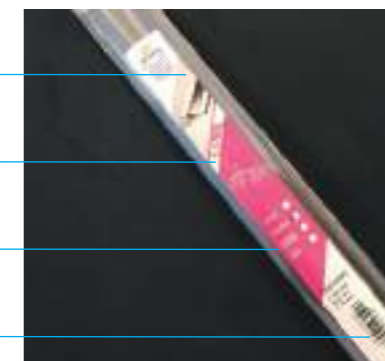

**Antidrucciolo applicato.**  
**Non-slip tape applied.**  
**Antidérapant appliqué.**  
**Antideslizante aplicado.**



**Antidrucciolo non applicato.**  
**Non-slip tape not applied.**  
**Antidérapant non appliqué.**  
**Antideslizante no aplicado.**

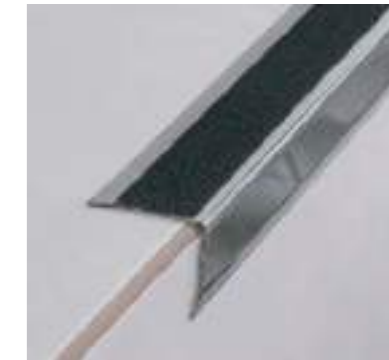

**Profilo con base:** Il profilo viene fornito completo di base.  
**Profile with base:** The profile is supplied complete with base.  
**Profilé avec base:** Le profilé est fourni complet avec base.  
**Perfil con base:** El perfil se suministra completo con base.



**Articoli disponibili nel Deposito Francia.**  
**Items available in the France warehouse.**  
**Articles disponibles dans l'entrepôt France.**  
**Artículos disponibles en el almacén de Francia.**

**AVERTISSEMENTS**

Les profilés Arcansas ne nécessitent pas d'entretien particulier et sont faciles à nettoyer à l'alcool ou à l'aide de détergent normaux à base non acide. Il est recommandé d'utiliser des éponges et/ou des chiffons non abrasifs pour éviter de rayer et/ou d'endommager l'anodisation, le polissage, la peinture et la finition. La résistance aux agents chimiques dépend du degré d'agression et il est donc nécessaire de s'assurer préventivement des effets des produits utilisés pour le nettoyage, la pose et l'entretien. La chaux, les mortiers et les autocollants pour tuiles peuvent provoquer des taches sur la surface visible des profilés. Il est donc indispensable de nettoyer ces pièces immédiatement après la pose.

**ADVERTENCIAS**

Los perfiles Arcansas no requieren un mantenimiento especial y pueden limpiarse fácilmente con alcohol o utilizando detergentes normales sin ácido. Se recomienda utilizar esponjas y/o paños no abrasivos para evitar rayar y/o dañar la anodización, el pulido, la pintura y el acabado. La resistencia a los agentes químicos depende del grado de agresión y por lo tanto es necesario asegurarse de los efectos preventivos de los productos utilizados para la limpieza, la instalación y el mantenimiento. La cal, las maltas y los adhesivos para baldosas pueden provocar manchas en la superficie visible de los perfiles. Por lo tanto, es indispensable limpiar estas partes inmediatamente después de la colocación.



# productivity

the character is recognized by its profile

We transform **aluminum, stainless steel, brass, iron and pvc** into products with strong aesthetic and technical impact thanks to a **constant research of quality** in the raw materials.

The search of the best raw materials and the **variety of finishes available** are the first steps to create an excellent product. This is why we put great attention and care in the selection and research of the materials we produce our profiles. Our wide range of finishes goes from the brushed, chromed, copper aluminum to the glossy and mat pvc. The close collaboration with our suppliers allow us to develop and research **ad hoc products** to satisfy the very different needs of each customer.

“The beauty and care in the finishes show great attention to details, which is not obvious in the production of profiles.

*Quality control manager*

## production cycle / raw materials

Iron cutting



### EXCLUSIVE FINISHES

Thanks to careful analysis and to our know how, we offer a **real alternative to standard finishes** of the profiles on the market. We've been the first ones to introduce new decorative finishes for aluminum, pvc, iron and stainless steel in the field of hardware and do-it-yourself.

Stamping, profiling and cutting line



Anodic bath



Brushing

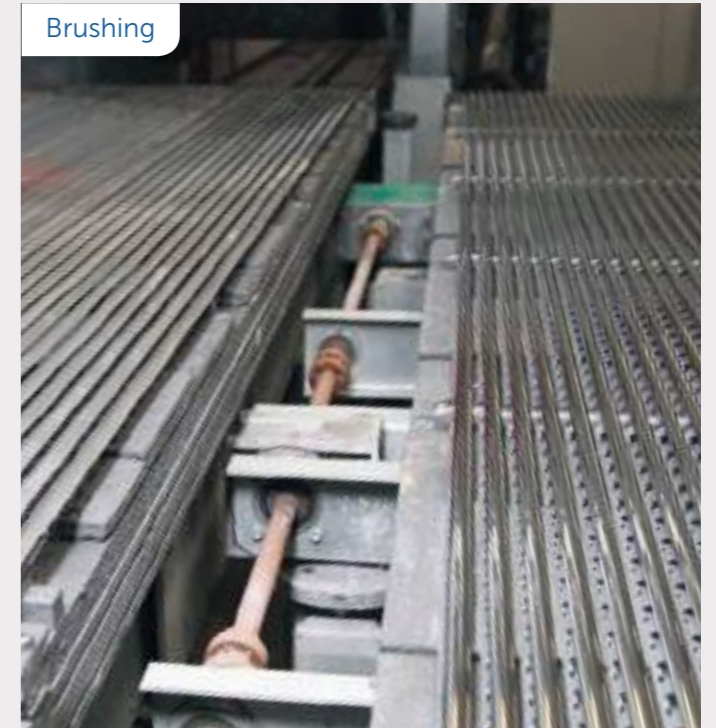

production cycle / production /

# productivity

the character is recognized by its profile

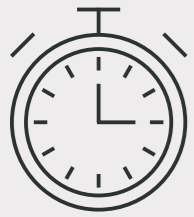

## 450

profiles blistered in an hour

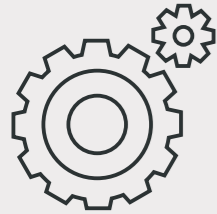

## 16h

one production cycle

To whom asks which is the secret recipe to produce high-level profiles we answer: **experience, the people and technology.**

We like the nice things, and we know that to create them you need not only **technologically advanced tools**, but also the passion and ability of qualified persons that can use them. We dedicate **great care in the selection and training of our staff**, always keeping an eye on technological innovation, to offer a complete product.



Bending-off press



Iron cutting line



## 3500

pieces produced in an hour of bending-off press

production cycle / production



Iron processing line



PVC extrusion

## 1800

profiles processed each hour per machine



Blister machine



Double-sided adhesive application



Boxes packaging



### GUARANTEED QUALITY

The **control of the production process** and the traceability are our absolute priorities. All the raw materials are controlled upon entrance and are monitored in each processing stage. We carry out

pre-established sample checks on all products through the use of **certified tools** and with the direct co-operation of specialized laboratories in the testing of materials and finishes.

# *PROFILI DI PROTEZIONE PER PIASTRELLE CERAMICHE*

Profiles for ceramic tile protection

Profils de protection pour carreaux en Céramique

Perfiles de protección para azulejos





# Acciaio Inox e Ottone

Stainless Steel and Brass/Acier Inoxydable et Laiton/ Acero inoxidable y latón

## Acciaio Inox e Ottone:

I profili di protezione Arcansas sono una linea di profili progettati per raccordare e proteggere gli angoli esterni dei rivestimenti in ceramica. Disponibili in differenti sezioni, altezze, in due materiali pregiati, in finitura lucida e spazzolata.

## Stainless steel and brass:

Arcansas protection profiles are designed to connect and protect the external corners and edges of ceramic tiles coverings. Available in two precious materials, with polished or brushed finishing and in different sections and heights.

## Acier inoxydable et laiton:

Les profilés de protection Arcansas sont une gamme de profilés conçus pour connecter et protéger les coins externes des revêtements en céramique. Disponible en différentes sections, hauteurs, en deux matériaux précieux, en finition polie et brossée.

## Acero inoxidable y latón:

Los perfiles de protección Arcansas son una línea de perfiles diseñados para conectar y proteger las esquinas externas de los revestimientos cerámicos. Disponible en diferentes secciones, alturas, en dos materiales preciados, en acabado brillo y cepillado.

## Acciaio Inox:

Ottenuti per profilatura nella lega più nobile disponibile oggi sul mercato, AISI 304 V2A, grazie alla sua elevatissima inossidabilità e resistenza agli agenti meccanici e atmosferici, è adatto per interni ed esterni. Ha un aspetto elegante e solido. Adatto in edilizia, altamente protettivo e decorativo.

## Stainless steel:

Obtained by profiling in alloy AISI 304 V2A, the noblest alloy available on the market today, thanks to a very high resistance to rust and to mechanical and atmospheric agents, it is suitable for indoor and outdoor decoration. It has an elegant and solid appearance. Suitable for construction, highly protective and decorative.

## Acier inoxydable:

Obtenu par profilage dans l'alliage le plus noble disponible sur le marché aujourd'hui, l'AISI 304 V2A, grâce à sa très haute résistance à la rouille et sa résistance aux agents mécaniques et atmosphériques, convient pour l'intérieur et l'extérieur. Il a une apparence élégante et solide. Convient pour la construction. Hautement protecteur et décoratif.

## Acero inoxidable:

Obtenido al perfilar la aleación más noble disponible en el mercado hoy en día, AISI 304 V2A, gracias a su muy alta resistencia a la oxidación y resistencia a los agentes mecánicos y atmosféricos, es indicado sea para interiores y exteriores. Tiene un aspecto elegante y sólido. Idóneo en construcción, altamente protector y decorativo.

## Vantaggi:

Elevatissima resistenza alla corrosione acida, salina o agenti atmosferici. Adatto al calpestio. Idoneo per interni ed esterni. Fornito con pellicola protettiva per la massima lavorabilità senza graffi o macchie. Manutenzione assente. Riciclabile nei metalli.

## Advantages:

Very high resistance to acid, saline or atmospheric agent's corrosion. Suitable for foot traffic. Well-suited for indoors and outdoors. Supplied with protective film for maximum workability without scratches or stains. No maintenance. Recyclable.

## Avantages:

Très haute résistance à la corrosion acide, saline ou atmosphérique. Ne craint pas le piétinement. Convient pour l'intérieur et l'extérieur. Fourni avec un film protecteur pour une facilité d'usage et un résultat sans rayures ni taches. Aucun entretien. Recyclable en métaux.

## Ventajas:

Muy alta resistencia a la corrosión por agentes ácidos, salinos o atmosféricos. Resistente a las pisadas. Idoneo para interior y exterior. Se suministra con película protectora para una máxima trabajabilidad sin arañazos ni manchas. Sin mantenimiento. Reciclabile en metales.

## Ottone lucido:

Profili ottenuti da estrusione della lega OT57 e, a seconda dell'articolo, lucidati meccanicamente con paste lucidanti. Ottima resistenza agli agenti chimici, atmosferici e alle sollecitazioni meccaniche. La superficie brillante e il colore tipico dell'ottone rendono questi profili altamente adatti in ambito decorativo.

## Polished brass:

Profiles obtained by extrusion of alloy OT57 and, depending on the article, mechanically polished with polishing pastes. Excellent resistance to chemical agents and mechanical stress. The bright surface and the typical color of the brass make these profiles highly suitable in the decorative field.

## Laiton poli:

Profilés obtenus par extrusion de l'alliage OT57 et, selon l'article, polis mécaniquement avec des pâtes à polir. Excellente résistance aux agents chimiques, atmosphériques et aux contraintes mécaniques. La surface brillante et la couleur typique du laiton rendent ces profilés très appropriés dans le domaine décoratif.

## Latón cromado:

Perfiles obtenidos por extrusión de la aleación OT57 y, según el producto, cromado mecánicamente con pastas de pulido. Excelente resistencia a agentes químicos, atmosféricos y al estrés mecánico. La superficie brillante y el color típico del latón hacen que estos perfiles sean muy adecuados en el ámbito decorativo.

## Vantaggi:

Elevatissima resistenza alla corrosione acida, salina o agenti atmosferici. Adatto al calpestio. Idoneo per interni ed esterni. Fornito con pellicola protettiva per la massima lavorabilità senza graffi o macchie. Manutenzione assente. Riciclabile nei metalli.

## Advantages:

Very high resistance to acid, saline or atmospheric agent's corrosion. Suitable for foot traffic. Well-suited for indoors and outdoors. Supplied with protective film for maximum workability without scratches or stains. No maintenance. Recyclable.

## Avantages:

Très haute résistance à la corrosion acide, saline ou atmosphérique. Ne craint pas le piétinement. Convient pour l'intérieur et l'extérieur. Fourni avec un film protecteur pour une facilité d'usage et un résultat sans rayures ni taches. Aucun entretien. Recyclable en métaux.

## Ventajas:

Muy alta resistencia a la corrosión por agentes ácidos, salinos o atmosféricos. Resistente a las pisadas. Idoneo para interior y exterior. Se suministra con película protectora para una máxima trabajabilidad sin arañazos ni manchas. Sin mantenimiento. Reciclabile en metales.

INOXCER	Finitura - Finish	Caratteristiche	EAN	Cod.	H. (mm)	L. (m)	Conf. - Carton	Min. ord.	
	acciaio inox lucido AISI 304 polished AISI 304 s.steel			8013237611811	061R1L	6	2,50	10	5
				8013237049614	061RL	8	2,50	10	5
				8013237066789	061RL2	8	1,0	10	5
				8013237049607	061SL	10	2,50	10	5
				8013237066536	061SL2	10	1,0	10	5
				8013237049645	061TL	12,5	2,50	10	5
	acciaio inox super lucido AISI 304 high gloss AISI 304 s.steel			8013237139179	061VL	22	2,50	10	5
				8013237140328	061RL/SL	8	2,50	10	5
				8013237063009	061SL / SL	10		10	5
	8013237140335	061TL/SL	12,5	10	5				
	acciaio inox spazzolato AISI 304 brushed AISI 304 s.steel			8013237049621	061RS	8	2,50	10	5
				8013237069957	061RS2	8	1,0	10	5
8013237049638				061SS	10	2,50	10	5	
8013237069964				061SS2	10	1,0	10	5	
8013237049652				061TS	12,5	2,50	10	5	
8013237138554				061TS2	12,5	1,00	10	5	

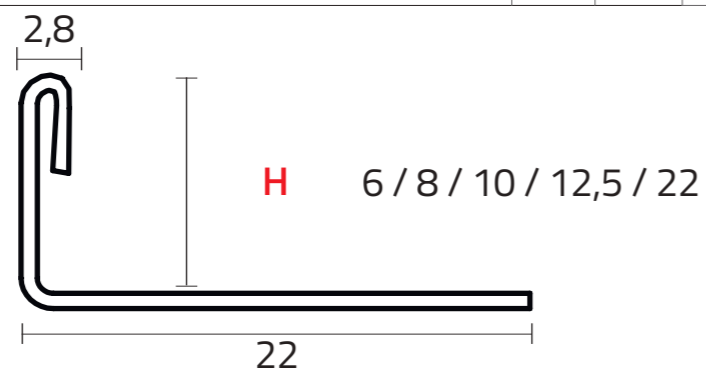

Listello decorativo / Decorative listello



Protezione spigolo/ Corner protection







Chiusura perimetrale a pavimento/ Ground covering edging

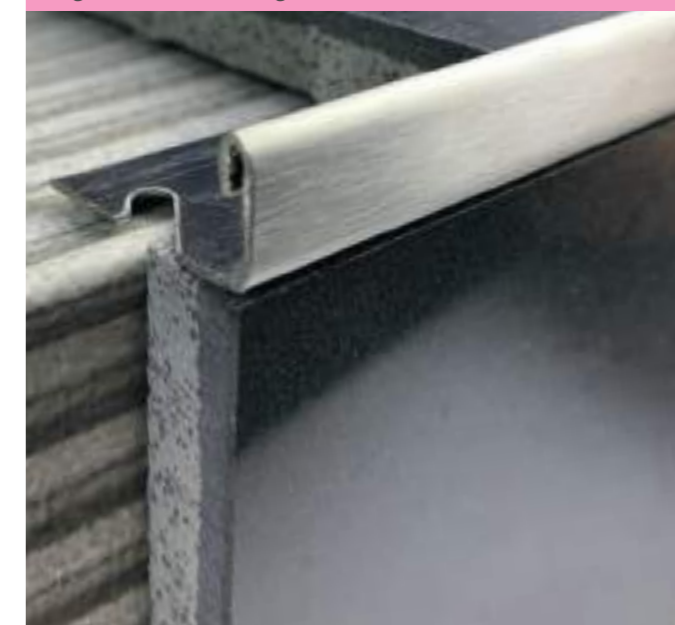

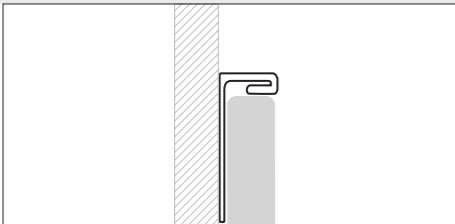
Paragradino/ Stair nosing



INOXCER 430	Finitura - Finish	Caratteristiche	EAN	Cod.	H. (mm)	L. (m)	Conf. - Carton	Min. ord.		
	 acciaio inox lucido AISI 430 polished AISI 430 s.steel	 	8013237137755	061RL2/430	8	1,00	10	5		
			8013237137762	061SL2/430	10		10	5		
			8013237137700	061RL/430	8		10	5		
			8013237137717	061SL/430	10		10	5		
			8013237137724	061TL/430	12,5		10	5		

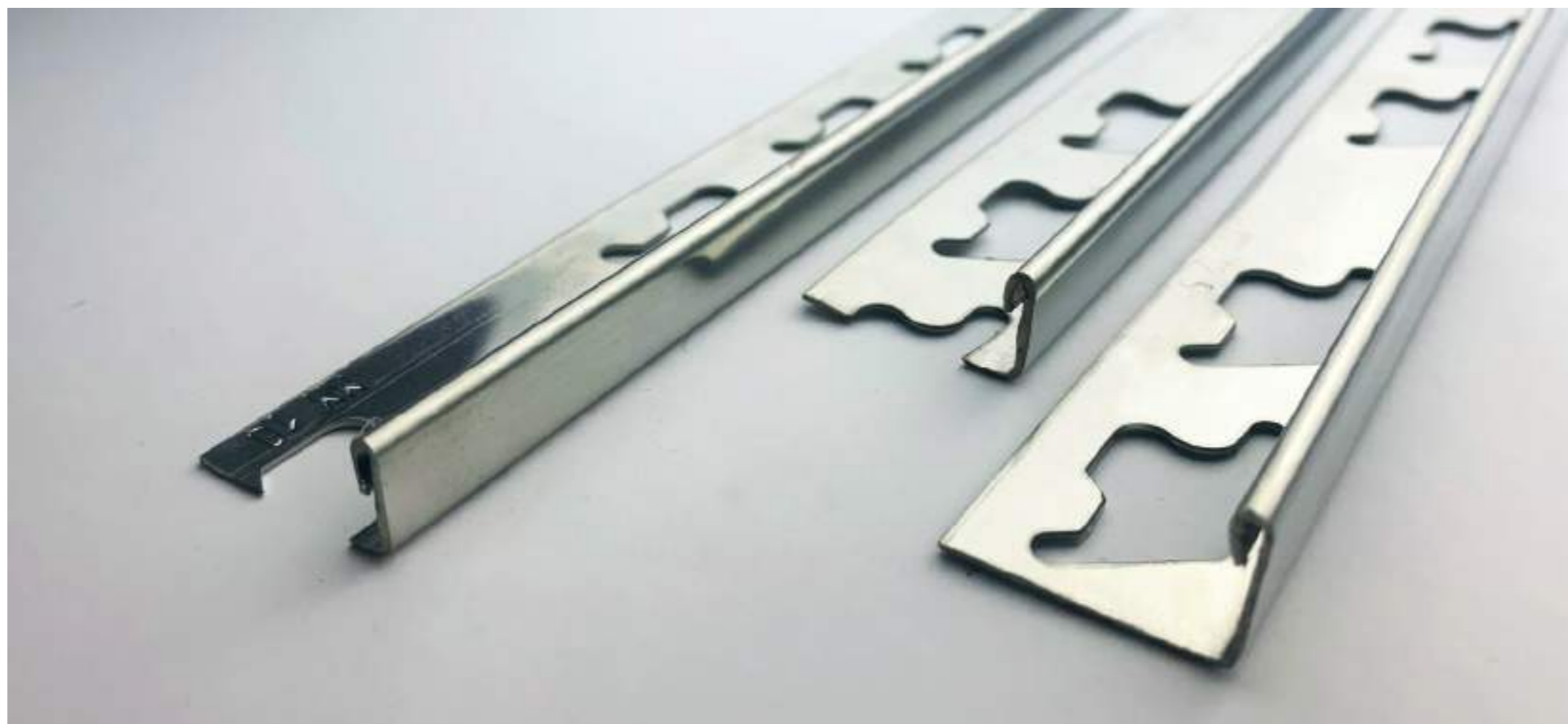
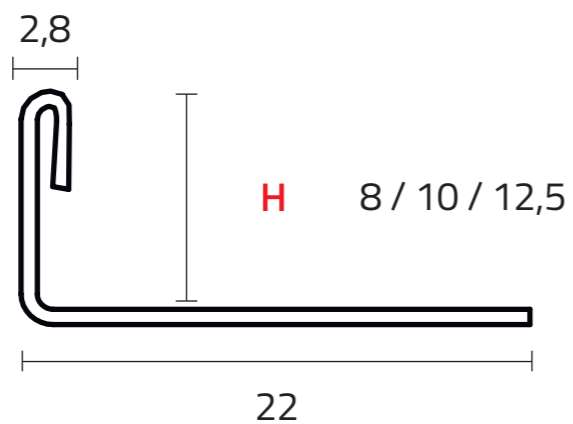

CUBINOX	Finitura - Finish	Caratteristiche	EAN	Cod.	H. (mm)	L. (m)	Conf. - Carton	Min. ord.
			8013237133283	258E1	FR 8	2,50	10	5
			8013237047276	258A	FR 10			
			8013237019563	258C	FR 12,5			
			8013237138608	258E1/M	FR 8			
			8013237133207	258E	FR 8	2,50	10	5
			8013237047269	258	FR 10			
			8013237019440	258B	FR 12,5			
			8013237138639	258E/SL	FR 8	2,50	10	5
			8013237062903	258 / SL	FR 10			
			8013237062910	258B / SL	FR 12,5			

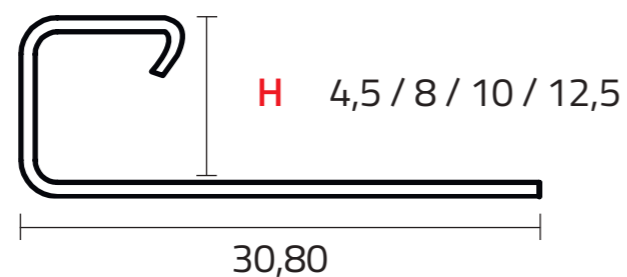

Listello decorativo / Decorative listello



Protezione spigolo / Corner protection

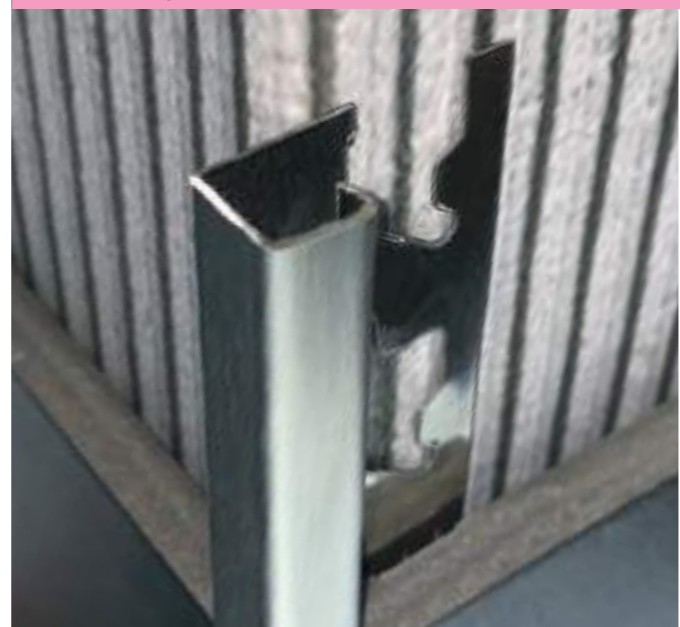

Chiusura perimetrale a muro / Wall covering edging



Paragradino / Stair nosing



\* Profili compatibili con capsule a pagina 30-32  
Profiles compatible with caps on page 30-32



\* Capsula 2/3 vie  
\* Cap 2/3 way



\* Capsula 2/3 vie  
\* Cap 2/3 way



CAPSULE/ CAPS

Finitura - Finish		EAN	Cod.	H. (mm)	Pz.	Min. ord.
	acciaio inox spazzolato AISI 304	8013237061326	258T15	10	1	10
	brushed AISI 304 s.steel					



Min. ord 10 pz

BLISTER

Finitura - Finish		EAN	Cod.	H. (mm)	Pz.	Min. ord.
	acciaio inox spazzolato AISI 304	8013237139964	258T2S/BLISTER	8	2	5
	brushed AISI 304 s.steel	8013237083755	258T1S/BLISTER	10	2	5
		8013237083779	258TS/BLISTER	12,5	2	5

CAPSULE/ CAPS

Finitura - Finish		EAN	Cod.	H. (mm)	Pz.	Min. ord.
	acciaio inox lucido AISI 304	8013237133313	258T2	8	1	10
	polished AISI 304 s.steel	8013237058579	258T1	10	1	10
		8013237058180	258T	12,5	1	10



Min. ord 10 pz

BLISTER

Finitura - Finish		EAN	Cod.	H. (mm)	Pz.	Min. ord.
	acciaio inox lucido AISI 304	8013237139957	258T2/BLISTER	8	2	5
	polished AISI 304 s.steel	8013237083748	258T1/BLISTER	10	2	5
		8013237083762	258T/BLISTER	12,5	2	5





\* Capsula 2/3 vie  
\* Cap 2/3 way



### CAPSULE/ CAPS

Finitura - Finish	EAN	Cod.	H. (mm)	Pz.	Min. ord.
acciaio inox super lucido AISI 304					
high gloss AISI 304 s.steel					



Min. ord 10 pz

### BLISTER

Finitura - Finish	EAN	Cod.	H. (mm)	Pz.	Min. ord.
acciaio inox super lucido AISI 304	8013237140106	258T2/BLISTER/SL	8	2	5
high gloss AISI 304 s.steel	8013237138806	258T1/BLISTER/SL	10	2	5
	8013237138905	258T/BLISTER/SL	12,5	2	5



RONDINOX	Finitura - Finish	Caratteristiche	EAN	Cod.	H. (mm)	L. (m)	Conf. - Carton	Min. ord.
	acciaio inox spazzolato AISI 304 brushed AISI 304 s.steel		8013237046910	257A3S	8		10	5
			8013237046927	257A5S	10			
			8013237046637	257B6S	12,5			
			8013237066802	257A5S2	10			
	acciaio inox lucido AISI 304 polished AISI 304 s.steel		8013237046873	257A3L	8		10	5
			8013237046880	257A5L	10			
			8013237046620	257B6L	12,5			
			8013237066796	257A5L2	10			
	acciaio inox superlucido AISI 304 high gloss AISI 304 s.steel		8013237062934	257A3L/SL	8		10	5
			8013237062927	257A5L/SL	10			
			8013237062941	257B6L/SL	12,5			

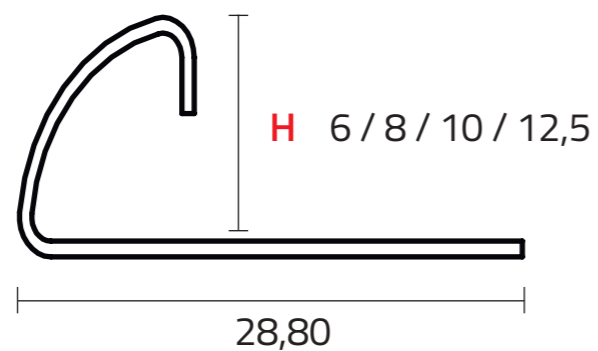

Chiusura perimetralea muro/ Wall covering edging



Protezione spigolo/ Corner protection



Chiusura perimetrale a pavimento/ Ground covering edging



Paragradino/ Stair nosing



\* Profili compatibili con capsule a pagina 36-38  
Profiles compatible with caps on page 36-38



\* Capsula 2/3 vie  
\* Cap 2/3 way



\* Capsula 2/3 vie  
\* Cap 2/3 way



CAPSULE/ CAPS

Finitura - Finish		EAN	Cod.	H. (mm)	Pz.	Min. ord.
	acciaio inox spazzolato AISI 304	8013237060831	257C3	8	1	10
	brushed AISI 304 s.steel	8013237060848	257C4	10	1	10
		8013237060855	257C5	12,5	1	10



Min. ord 10 pz

BLISTER

Finitura - Finish		EAN	Cod.	H. (mm)	Pz.	Min. ord.
	acciaio inox spazzolato AISI 304	8013237083717	257C3/BLISTER	8	2	5
	brushed AISI 304 s.steel	8013237083731	257C4/BLISTER	10	2	5
		8013237138899	257C5/BLISTER	12,5	2	5

CAPSULE/ CAPS

Finitura - Finish		EAN	Cod.	H. (mm)	Pz.	Min. ord.
	acciaio inox lucido AISI 304	8013237053987	257C	8	1	10
	polished AISI 304 s.steel	8013237053994	257C1	10	1	10
		8013237054007	257C2	12,5	1	10



Min. ord 10 pz



BLISTER

Finitura - Finish		EAN	Cod.	H. (mm)	Pz.	Min. ord.
	acciaio inox lucido AISI 304	8013237083700	257C/BLISTER	8	2	5
	polished AISI 304 s.steel	8013237083724	257C1/BLISTER	10	2	5
		8013237138882	257C2/BLISTER	12,5	2	5

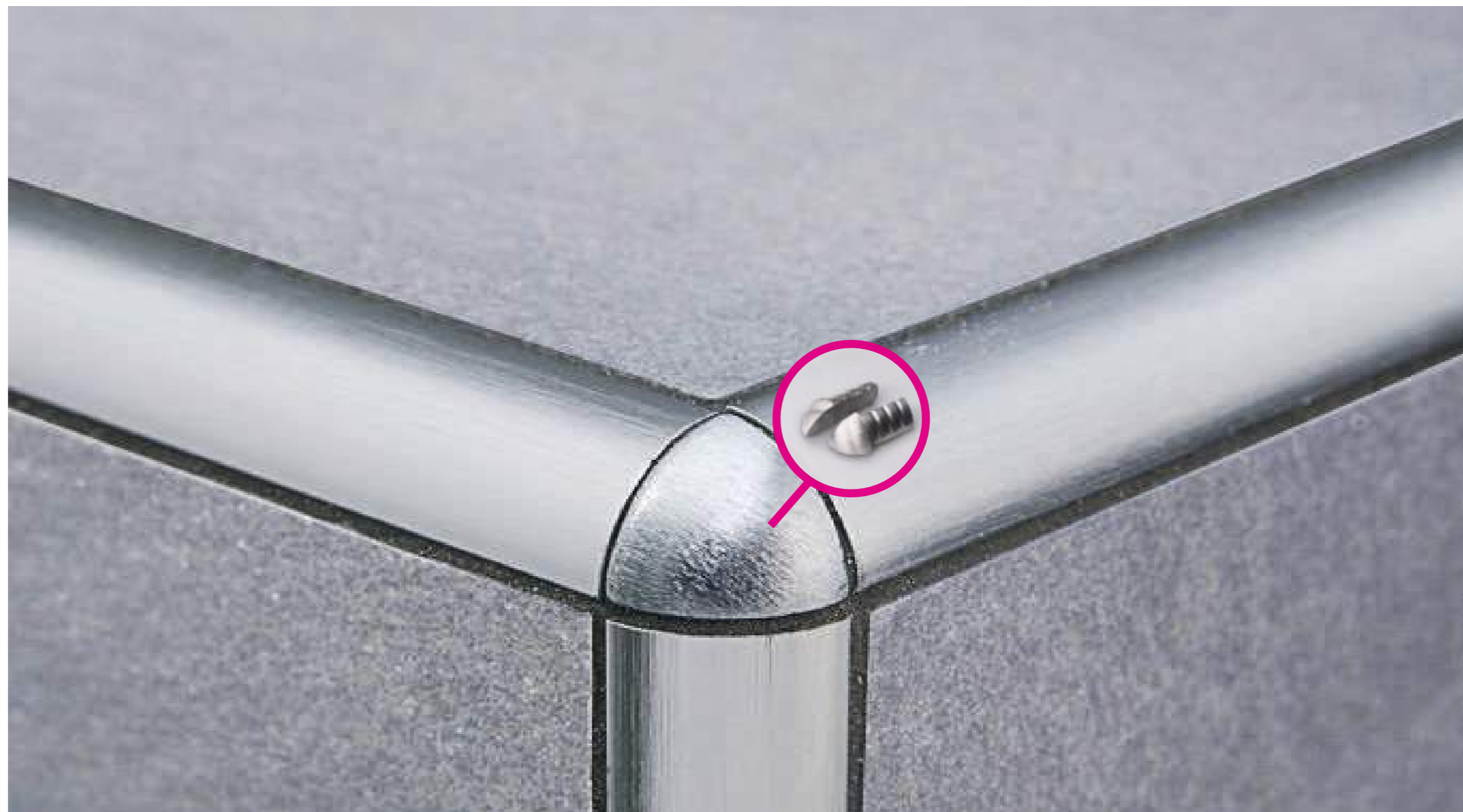

BLISTER		EAN	Cod.	H. (mm)	Pz.	Min. ord.
acciaio inox super lucido AISI 304		8013237138783	257C/BLISTER/SL	8	2	5
high gloss AISI 304 s.steel		8013237138776	257C1/BLISTER/SL	10	2	5
		8013237138790	257C2/BLISTER/SL	12,5	2	5

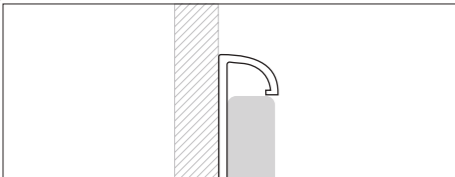

RONDINOX 430	Finitura - Finish	Caratteristiche	EAN	Cod.	H. (mm)	L. (m)	Conf. - Carton	Min. ord.
	 acciaio inox lucido 430 polished s. steel 430		8013237137731	257A3L / 430	8	2,50	10	5
			8013237137748	257A5L / 430	10			
			8013237137779	257A3L2 / 430	8	1,00	10	5
			8013237137786	257A5L2 / 430	10			

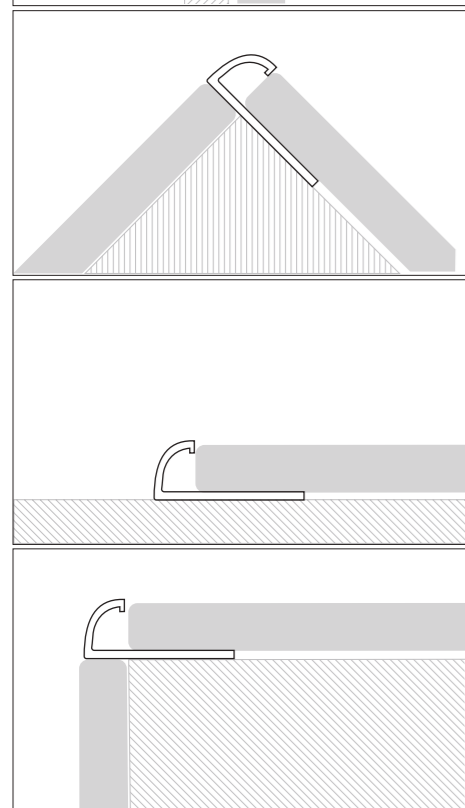
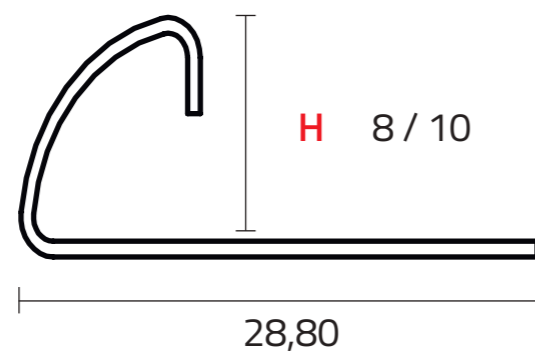

Chiusura perimetrale a muro/ Wall covering edging





Protezione spigolo/ Corner protection



Acciaio Inox spazzolato  
Brushed s. steel

Acciaio Inox lucido  
Polished s. steel

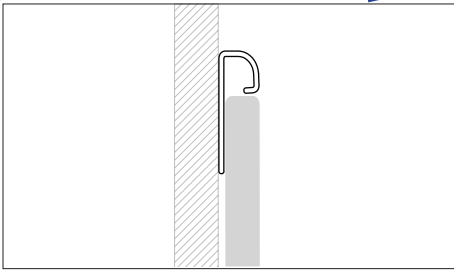
Acciaio Inox superlucido  
High Gloss s. steel

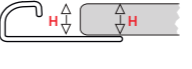
QUARTINOX	New	Finitura - Finish	Caratteristiche	EAN	Cod.	H. (mm)	L. (m)	Conf. - Carton	Min. ord.
		acciaio inox lucido AISI 304 polished AISI 304 s.steel							

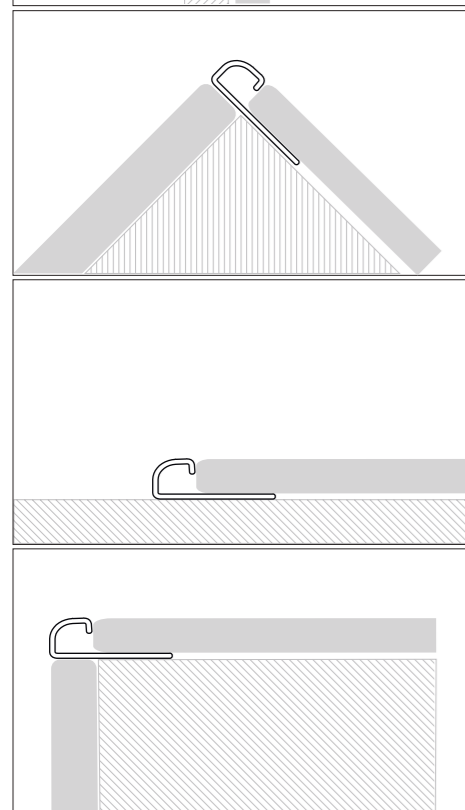
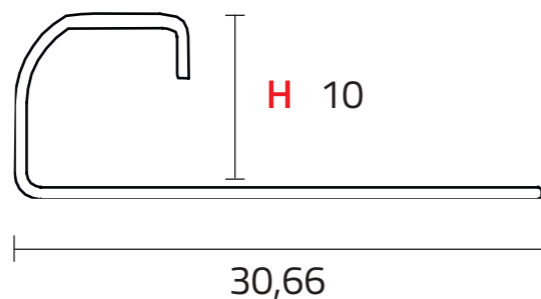

Chiusura perimetrale a pavimento/ Ground covering edging

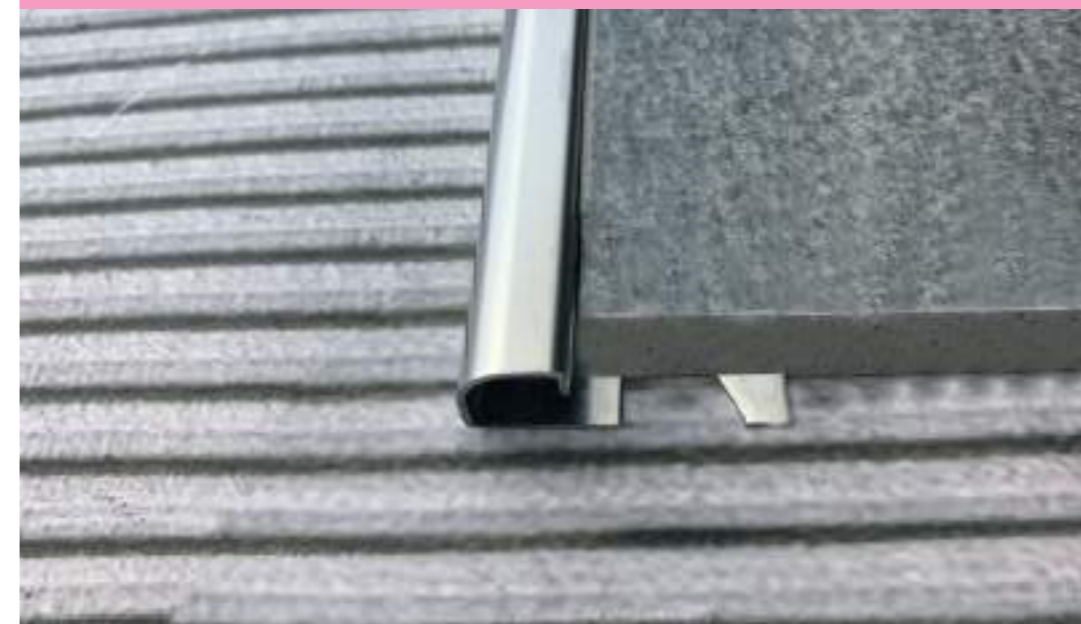

Chiusura perimetrale a muro/ Wall covering edging



Protezione spigolo/ Corner Protection



Paragradino / Stair nosing



 \* Profili compatibili con capsule a pagina 44  
Profiles compatible with caps on page 44



\*Capsula esterna 2/3 vie cod. 257C1R  
\*External Cap 2/3 way cod. 257C1R

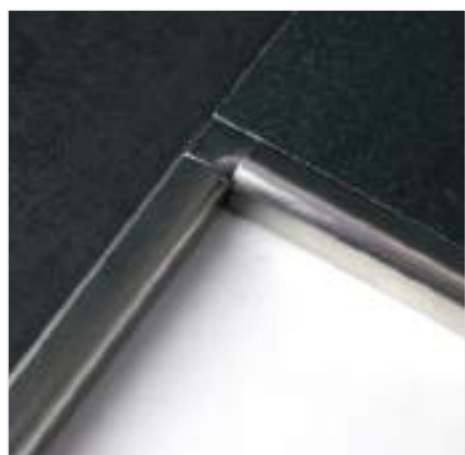

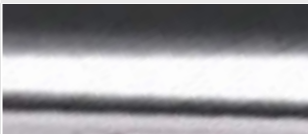

\* Capsula interna 2/3 vie cod. 257C1S  
\* Internal Cap 2/3 way cod. 257C1S

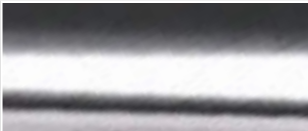
CAPSULE/ CAPS		EAN	Cod.	H. (mm)	Pz.	Min. ord.	
Finitura - Finish							
	acciaio inox AISI 304 AISI 304 s.steel	8013237147143	<b>257C1R</b>	10	1	10	

CAPSULE/ CAPS		EAN	Cod.	H. (mm)	Pz.	Min. ord.	
Finitura - Finish							
	acciaio inox AISI 304 AISI 304 s.steel						

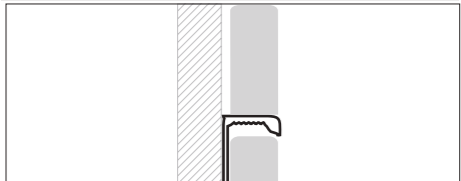

BRASCER	Finitura - Finish	Caratteristiche	EAN	Cod.	H. (mm)	L. (m)	Conf. - Carton	Min. ord.
	 ottone naturale natural brass		8013237060398	061B6A	8	1,0	10	5
			8013237061272	061B7	10	2,50	10	5
			8013237060404	061B7B	10	1,0	10	5

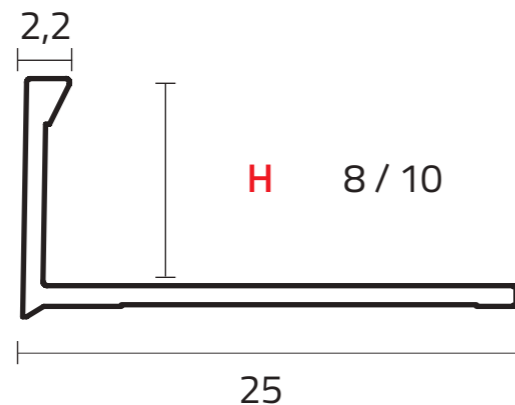

**Ottone naturale:**  
Profili ottenuti per estrusione, non sottoposti a trattamento di lucidatura meccanica con paste lucidanti. Ottima resistenza agli agenti chimici e alle sollecitazioni meccaniche. La superficie opaca e il colore tipico dell'ottone rendono questi profili non invasivi e adatti in ambito decorativo.

**Vantaggi:**  
Elevatissima resistenza alla corrosione acida, salina o agenti atmosferici. Adatto al calpestio. Per uso interno o esterno. Altamente inossidabile. Scarsa manutenzione. Riciclabile nei metalli.

**Natural brass:**  
Profiles obtained by extrusion, not mechanically polished with polishing pastes. Excellent resistance to chemical agents and mechanical stress. The opaque surface and the typical colour of the brass make these profiles discreet and suitable for decorative purposes.

**Advantages:**  
Very high resistance to acid, saline or atmospheric agent's corrosion. Suitable for foot traffic. Well-suited for indoors and outdoors. Highly stainless. No maintenance. Recyclable.

**Laiton naturel :**  
Profils obtenus par extrusion, non soumis à un traitement de polissage mécanique avec des pâtes à polir. Excellente résistance aux agents chimiques et aux contraintes mécaniques. La surface opaque et la couleur typique du laiton rendent ces profilés discrets et adaptés dans le domaine décoratif.

**Avantages :**  
Très haute résistance à la corrosion acide, saline ou atmosphérique. Ne craint pas le piétinement. Pour un usage extérieur ou intérieur. Hautement inoxydable. Très peu d'entretien. Recyclable en métaux.

**Latón natural:**  
Perfiles obtenidos por extrusión, no sometidos a tratamiento mecánico de pulido con pastas de pulido. Excelente resistencia a los agentes químicos y al estrés mecánico. La superficie opaca y el color típico del latón hacen que estos perfiles no sean invasivos y adecuados para el ámbito decorativo.

**Ventajas:**  
Muy alta resistencia a la corrosión por agentes ácidos, salinos o atmosféricos. Resistente a las pisadas. Idoneo para interior y exterior. Altamente inoxidable. Escaso mantenimiento. Reciclabile en metales.

Listello decorativo/ Decorative listello



Protezione spigolo/ Corner Protection

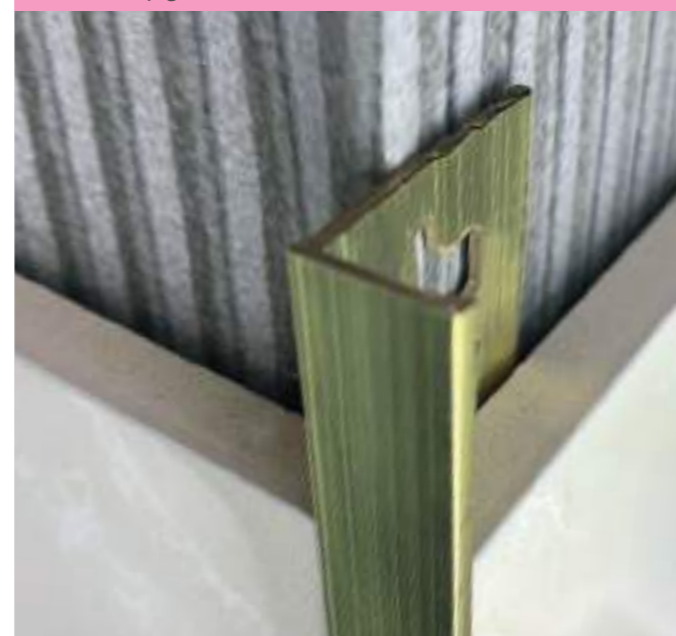

Chiusura perimetrale a muro/ Wall covering edging



Paragradino/ Stair nosing





CUBE BRASS	Finitura - Finish	Caratteristiche	EAN	Cod.	H. (mm)	L. (m)	Conf. - Carton	Min. ord.	€/m	€/pz
	 ottone lucido polished brass									
	 ottone cromato chrome brass									
			8013237066918	258R2 / C	10	1,00	10	5		
			8013237066925	258S2 / C	12,5		10	5		

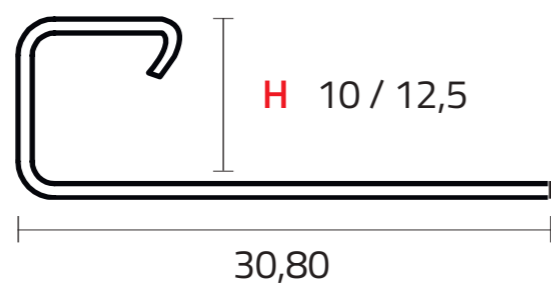

Chiusura perimetrale a muro / Wall covering edging



Protezione spigolo / Corner protection



\* Profili compatibili con capsule a pagina 50  
Profiles compatible with caps on page 50



\*Capsula 2/3 vie  
\*Cap 2/3 way

CAPSULE/ CAPS

Finitura - Finish	EAN	Cod.	H. (mm)	Pz.	Min. ord.	
ottone cromato						
chrome brass						



RONDBRASS	Finitura - Finish	Caratteristiche	EAN	Cod.	H. (mm)	L. (m)	Conf. - Carton	Min. ord.
	 ottone lucido polished brass							

	Finitura - Finish	Caratteristiche	EAN	Cod.	H. (mm)	L. (m)	Conf. - Carton	Min. ord.
	 ottone cromato chrome brass							

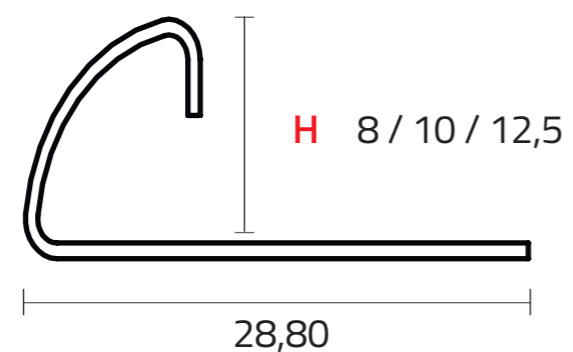
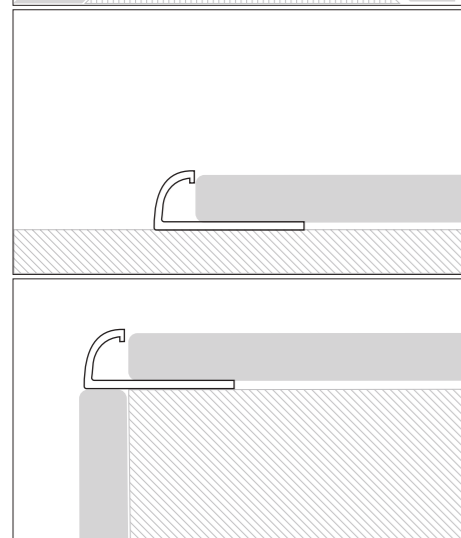

Chiusura perimetrale a muro/ Wall covering edging



Protezione spigolo/ Corner protection



Chiusura perimetrale a pavimento/ ground covering edging



Paragradino/ Stair nosing



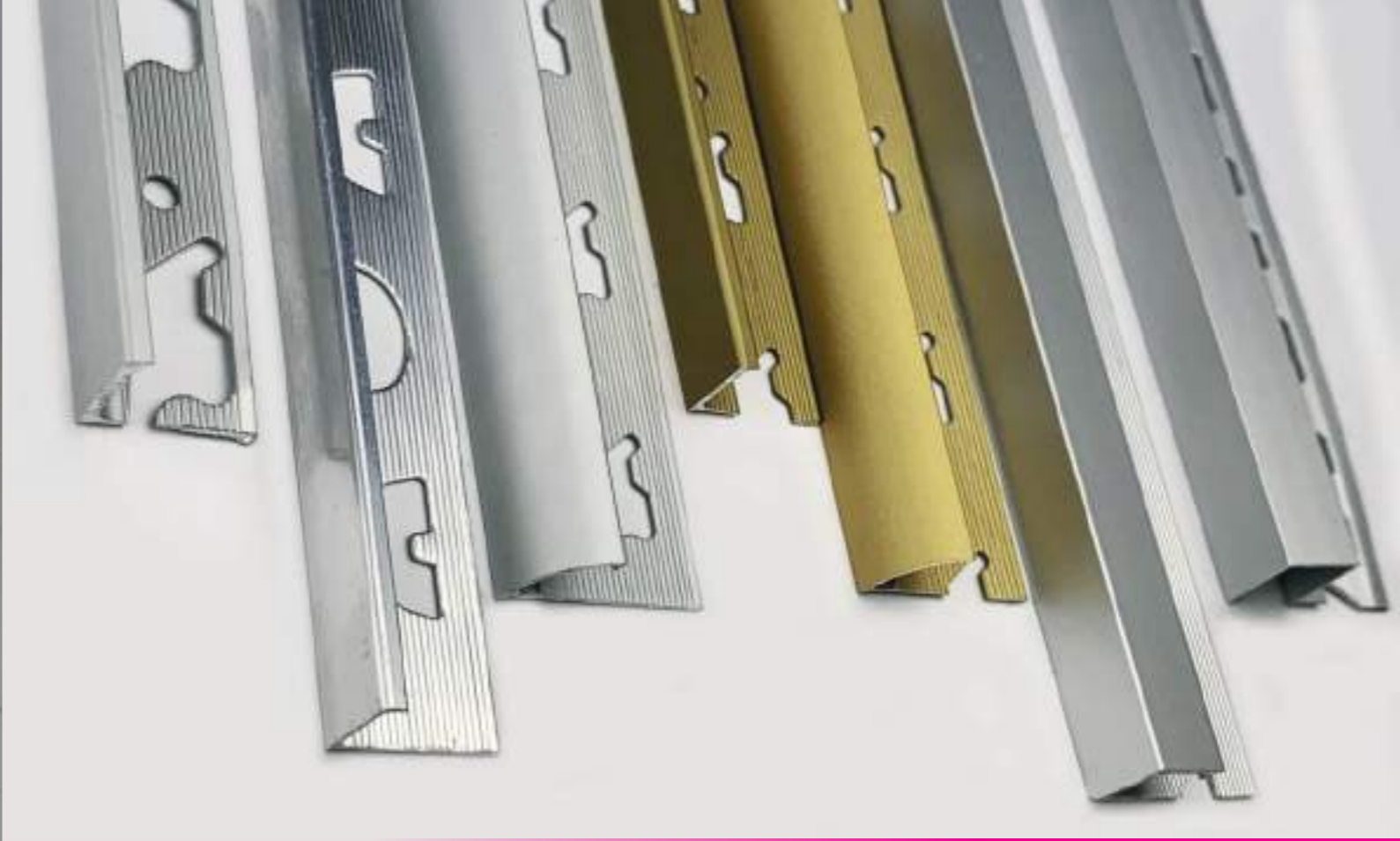

# Alluminio naturale e anodizzato satinato

Raw and satin anodised alu/ Alu naturel et anodisé satiné/ Alu natural y anodizado satinado

## Alluminio naturale e anodizzato satinato:

I profili di protezione Arcansas sono una linea di profili in alluminio progettati per raccordare e proteggere gli angoli esterni dei rivestimenti in ceramica. Disponibili in differenti sezioni, altezze e finiture.

Subisce un trattamento di ossidazione anodica per immersione in vasche elettrolitiche e successivamente nelle vasche del colore che viene poi fissato nelle ultime vasche del lungo processo anodico, dando vita ad uno strato protettivo che protegge il profilo. Arcansas garantisce uno spessore del trattamento da 10 a 15 µm secondo il tipo di colore per la massima qualità di protezione. Arcansas impiega la lega 6000 per ottenere una colorazione uniforme dal massimo grado di finitura estetica oltre che funzionale.

## Vantaggi:

Facilmente lavorabili grazie alla duttilità di questa lega. Elevato aumento della resistenza alla corrosione acida, salina o agenti atmosferici rispetto all' alluminio naturale. Elevata resistenza ai graffi ( non propria dell'alluminio naturale). Adatto per interni ed esterni. Riciclabile nell' alluminio.

## Raw and satin anodised aluminium:

Arcansas protection profiles are designed to connect and protect the external corners and edges of ceramic tiles coverings. Available in different sections, heights and finishing.

The aluminum profile undergoes an anodic oxidation treatment by immersion in electrolytic tanks first and subsequently in colour tanks to create a protective layer that protects the profile. For the highest quality of protection, Arcansas guarantees a treatment thickness of 10 to 15 µm depending to the colour type. Arcansas uses the 6000 alloy to obtain a uniform colouring with the highest degree of aesthetic as well as functional finish.

## Advantages :

Easily workable thanks to the ductility of this alloy. High increase in resistance to acid, saline or weathering corrosion compared to natural aluminium. High scratch resistance. Suitable for indoors and outdoors. Recyclable.

## Aluminium naturel et anodisé satiné :

Les profils de protection Arcansas sont une gamme de profils en aluminium conçus pour connecter et protéger les coins externes des revêtements en céramique. Disponible en différentes sections, hauteurs et finitions.

La transformation de ce matériau commence par sa plongée dans des cuves électrolytiques qui permettent l'oxydation anodique. Dans la phase suivante les produits passent dans des cuves de peinture. Dans les dernières cuves de ce long procédé la couleur est fixée et une couche protectrice qui protège le profilé est créée. L'épaisseur du traitement Arcansas est de 10 à 15 micron (selon la couleur) pour garantir une protection optimale. Afin d'obtenir une coloration uniforme Arcansas utilise une ligue 6000, qui donne au produit une finition esthétique maximale mais aussi fonctionnelle.

## Avantages :

Facile à utiliser grâce à la ductilité conférée par la ligue 6000. Résistance à la corrosion acide, saline et aux intempéries (majeure par rapport aux profils en aluminium naturel). Adaptables à l'intérieur et extérieur. Aluminium 100% recyclable.







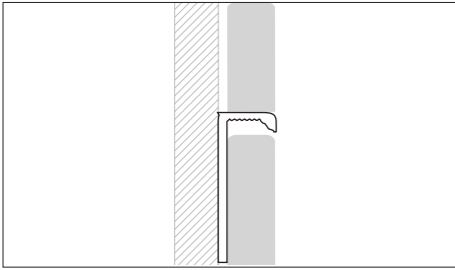
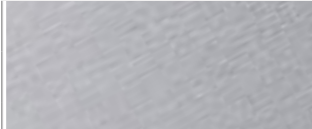

## Aluminio natural y anodizado satinado:

Los perfiles de protección Arcansas son una línea de perfiles de aluminio diseñados para conectar y proteger las esquinas externas de los revestimientos cerámicos. Disponible en diferentes secciones, alturas y acabados.

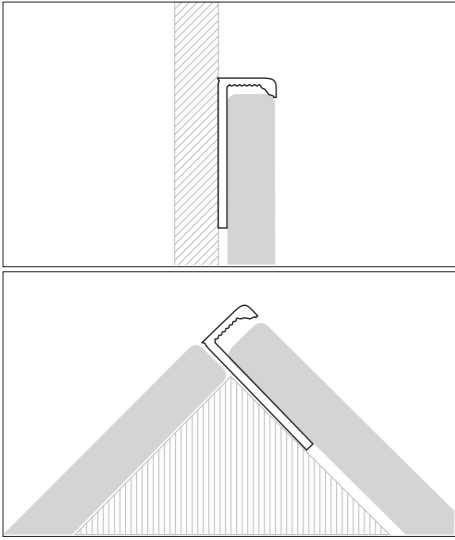
Se somete a un tratamiento de oxidación anódica por inmersión en tanques electrolíticos y posteriormente en tanques del color que luego se fija en los últimos tanques del largo proceso anódico, creando una capa protectora que protege el perfil. Arcansas garantiza un espesor de tratamiento de 10 a 15 µm según el tipo de color para la más alta calidad de protección. Arcansas utiliza la aleación 6000 para obtener una coloración uniforme con el más alto grado de acabado estético y funcional.

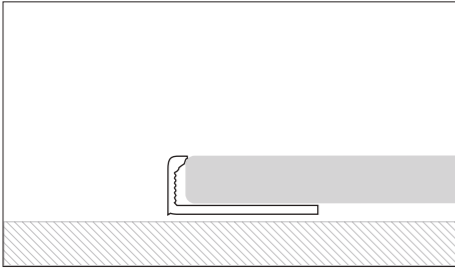
## Ventajas :

Fácilmente mecanizable gracias a la ductilidad de esta aleación. Elevado aumento de la resistencia a la corrosión ácida, salina o por agentes atmosféricos en comparación con el aluminio natural. Alta resistencia al rayado. Adecuado para interiores y exteriores. Reciclabile en el aluminio.

ALUCER	Finitura - Finish	Caratteristiche	EAN	Cod.	H (mm)	L (m)	Conf. Carton	Min. ord.			
	 <p>alluminio naturale natural aluminum</p>		8013237007614	061E	4,5	2,50	50	10			
			8013237061517	061E1	FR 6	2,50	50	10			
			8013237061692	061F9	FR 8	2,50	50	10			
			8013237061760	061G	FR 10	2,50	50	10			
			8013237008574	061H	FR 12,5	2,50	50	10			
			8013237066741	061F92	8	1,0	50	10			
			8013237066758	061G2	10	1,0	50	10			
			8013237007638	061E1 / 90	FR 6	2,50	50	10			
			8013237008086	061F9 / 90	FR 8	2,50	50	10			
			8013237008345	061G / 90	FR 10	2,50	50	10			
	 <p>argento anodizzato satinato anodised satin silver</p>		8013237072162	061G8 / 90	FR 11	2,50	50	10			
			8013237025878	061H / 90	FR 12,5	2,50	50	10			
			8013237144074	061H4 / 90	FR 15	2,50	50	10			
			8013237144098	061H5 / 90	FR 20	2,50	50	10			
			8013237133580	061G2 / 90	10	1,0	50	10			
			8013237138752	061H3 / 90	12,5	1,0	50	10			
			8013237008109	061F9 / 91	8	2,50	50	10			
			8013237008369	061G / 91	10	2,50	50	10			
				 <p>oro anodizzato satinato anodised satin gold</p>	  						

Listello decorativo/ Decorative listello



Chiusura perimetrale a muro/ Wall covering edging





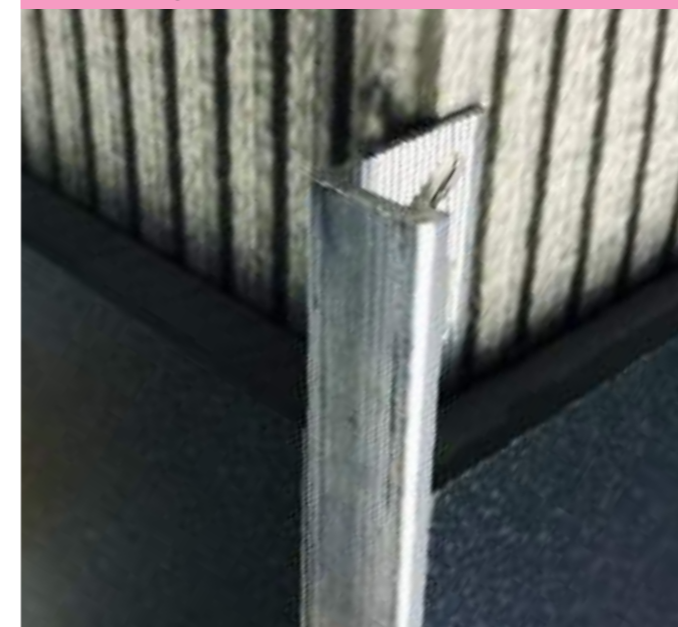





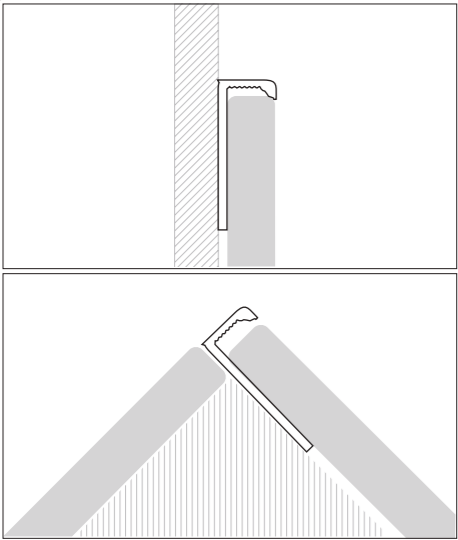









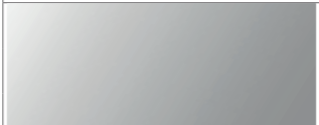



Protezione spigolo/ Corner protection



Chiusura perimetrale a pavimento/ Ground covering edging



ALUCER-ECO	Finitura - Finish	Caratteristiche	EAN	Cod.	H. (mm)	L. (m)	Conf. Carton	Min. ord.	
	 <p>alluminio naturale natural aluminum</p>		8013237137977	061E1 / F / N 	6	2,50	50	10	
			8013237137984	061F9 / F / N 	8		50	10	
			8013237137991	061G / F / N 	10		50	10	
			8013237138004	061H / F / N 	12,5		50	10	
	 <p>argento anodizzato satinato satin anodised silver</p>		8013237147105	061E1 / F / 90	6	2,50	50	10	
			8013237135461	061F9 / F / 90 	8		50	10	
			8013237135485	061G / F / 90 	10		50	10	
			8013237136031	061H / F / 90 	12,5		50	10	
		 <p>oro anodizzato satinato satin anodised gold</p>		8013237138714			1,00		
				8013237137915	061F92 / F / 90	8		50	10
				8013237137892	061G2 / F / 90	10	50	10	
									

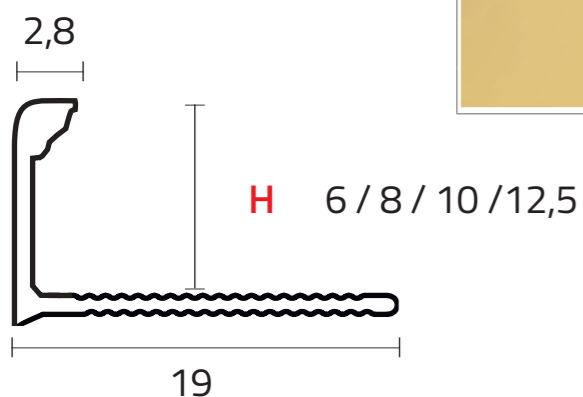







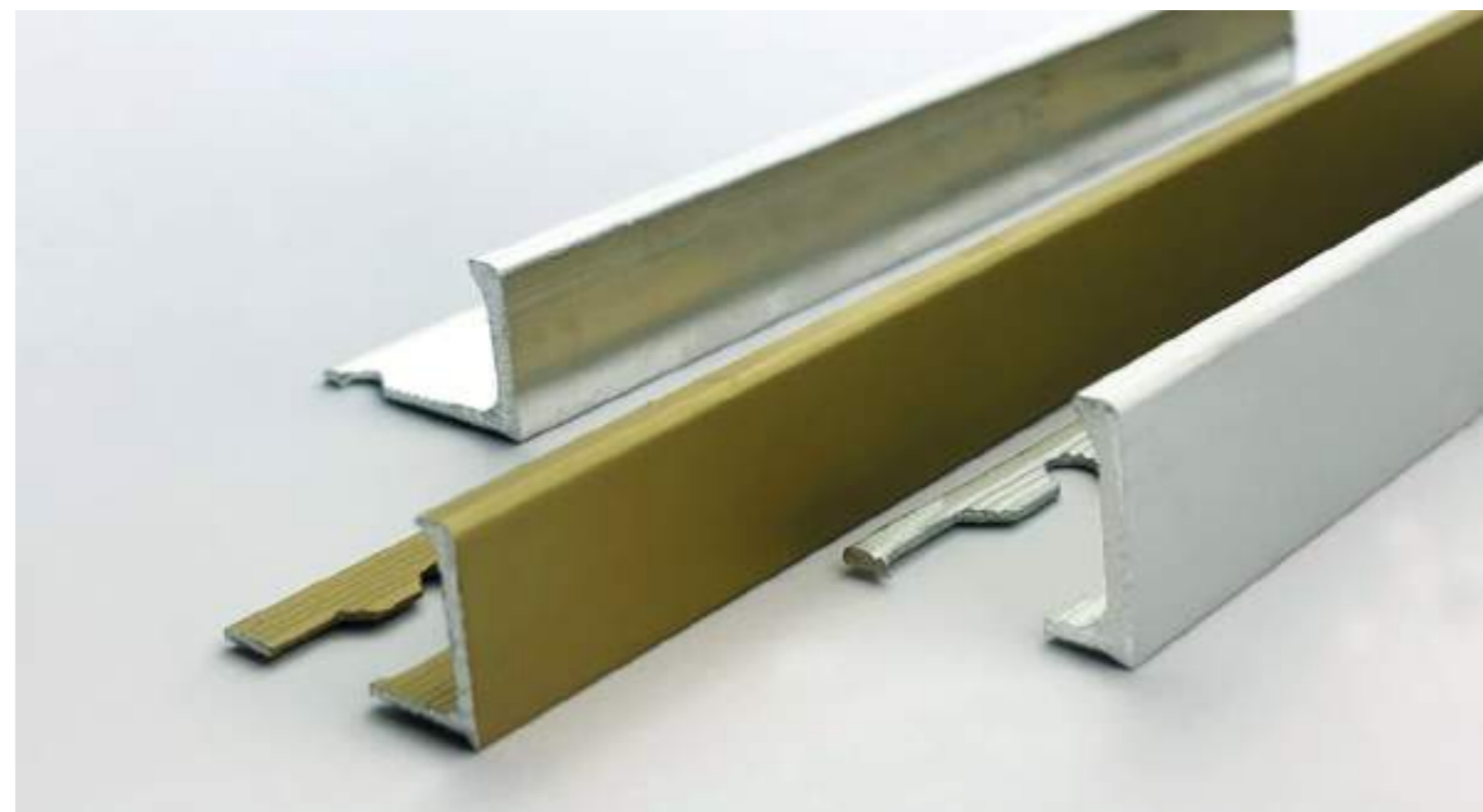

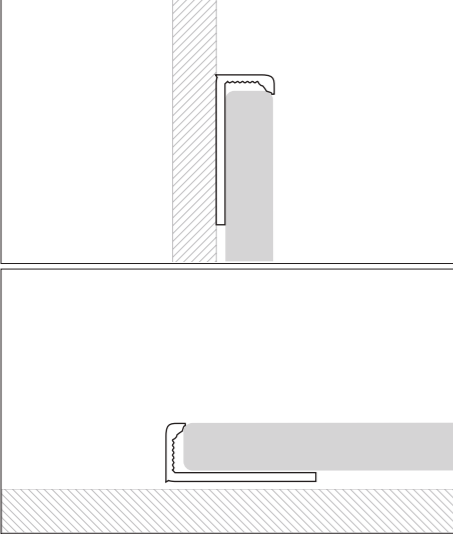

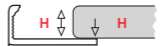

Chiusura perimetrale a muro/ Wall covering edging



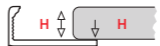

Protezione spigolo/ Corner protection

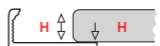

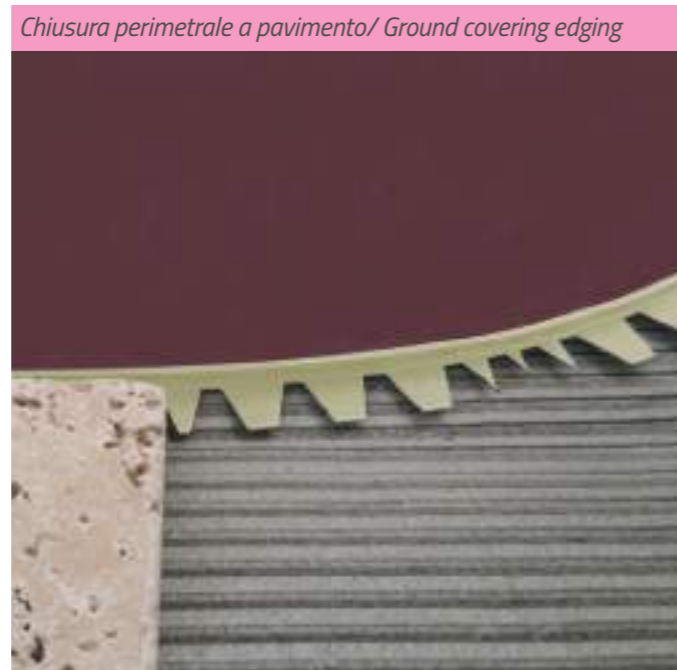
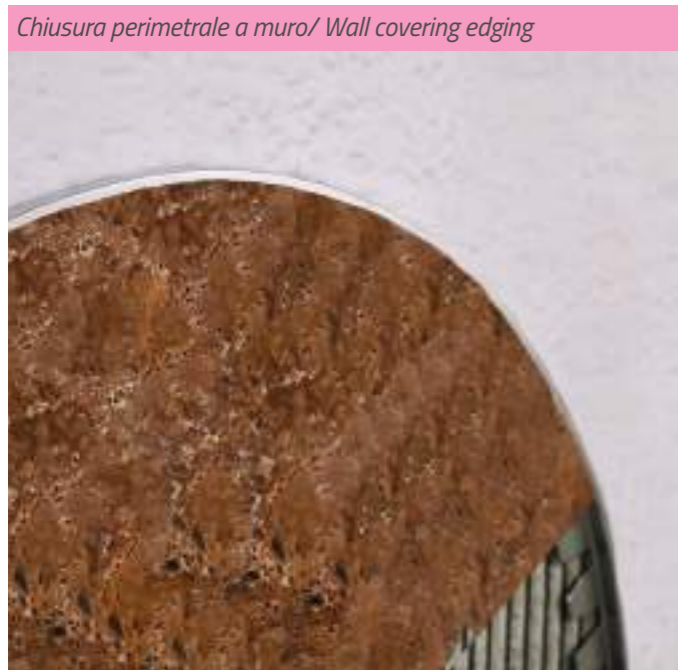
ALUCER versione piegabile/ beldable version	Finitura - Finish	Caratteristiche	EAN	Cod.	H. (mm)	L. (m)	Conf. Carton	Min. ord.
	 alluminio naturale natural aluminum Raggio di curvatura massimo: 40 cm Maximum bending radius: 40 cm	 						
	 argento anodizzato satinato satin anodised silver Raggio di curvatura massimo: 40 cm Maximum bending radius: 40 cm	 						
	 oro anodizzato satinato anodised satin gold Raggio di curvatura massimo: 40 cm Maximum bending radius: 40 cm	 						

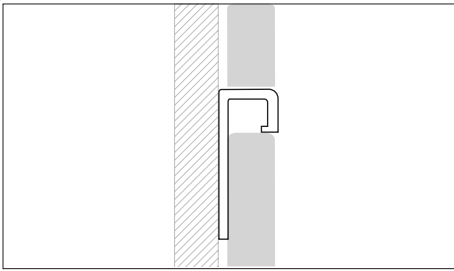

CUBALU	Finitura - Finish	Caratteristiche	EAN	Cod.	H. (mm)	L. (m)	Conf. Carton	Min. ord.
	argento anodizzato satinato satin anodised silver		8013237044176	041 / 90	FR 10	2,50	50	10
			8013237046682	043 / 90	FR 12,5			

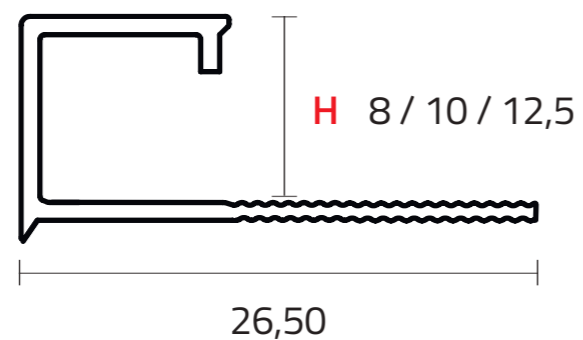

Conf. da 50 pz

Listello decorativo/ Decorative listello



Protezione spigolo/ Corner protection



Chiusura perimetrale a muro/ Wall covering edging



Paragradino/ Stair nosing

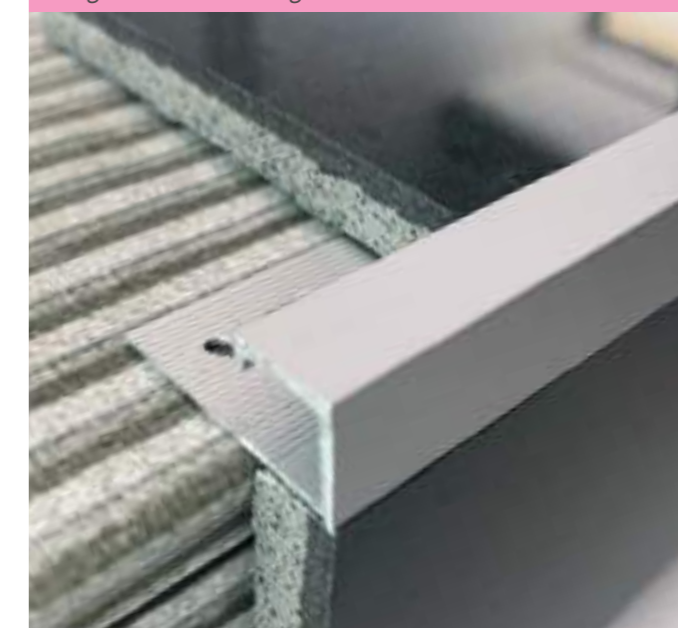

 \* Profili compatibili con capsule a pagina 66  
Profiles compatible with caps on page 66



ALUSQUARE	Finitura - Finish		Caratteristiche			EAN	Cod.	H. (mm)	L. (m)	Conf. Carton	Min. ord.
		argento anodizzato satinato				8013237135584	040/S/90	8	2,50	50	10
		satin anodised silver				8013237135553	041/S/90	10		50	10
						8013237135560	043/S/90	12,5		50	10
						8013237137878	041D/S/90	10	1,00	50	10
						8013237137885	043D/S/90	12,5		50	10

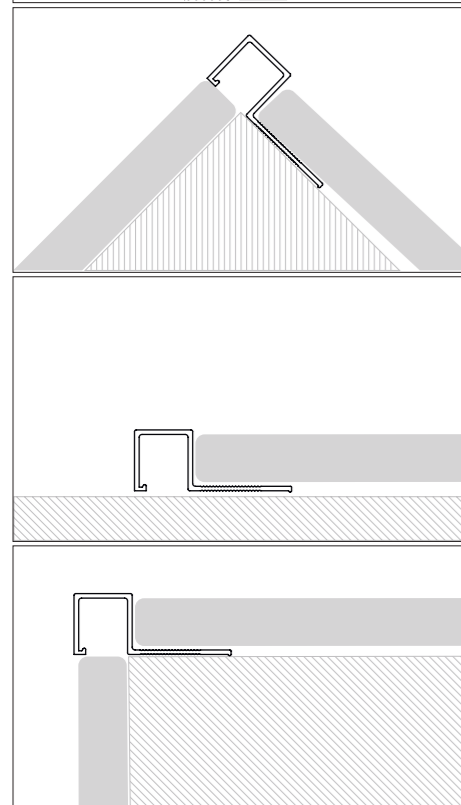
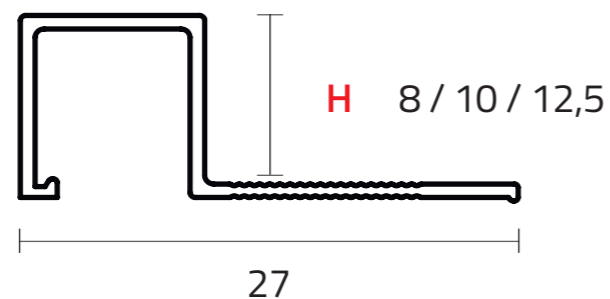

Listello decorativo/ Decorative listello



Protezione spigolo/ Corner protection



Chiusura perimetrale a pavimento/ Ground covering edging



Paragradino/ Stair nosing



\* Profili compatibili con capsule a pagina 66  
Profiles compatible with caps on page 66



\*Capsula 2/3 vie argento 90  
\*Cap 2/3 way silver 90



CAPSULE/ CAPS

Finitura - Finish		EAN	Cod.	H. (mm)	Pz.	Min. ord..	
	argento anodizzato	8013237079871	258H10	10	1	10	
	satinato						
	satin anodised silver	8013237079888	258H12	12,5	1	10	



Min. ord 10 pz

BLISTER

Finitura - Finish		EAN	Cod.	H. (mm)	Pz.	Min. ord..	
	argento anodizzato	8013237138813	258H10/BLISTER	10	2	5	
	satinato						
	satin anodised silver	8013237138868	258H12/BLISTER	12,5	2	5	

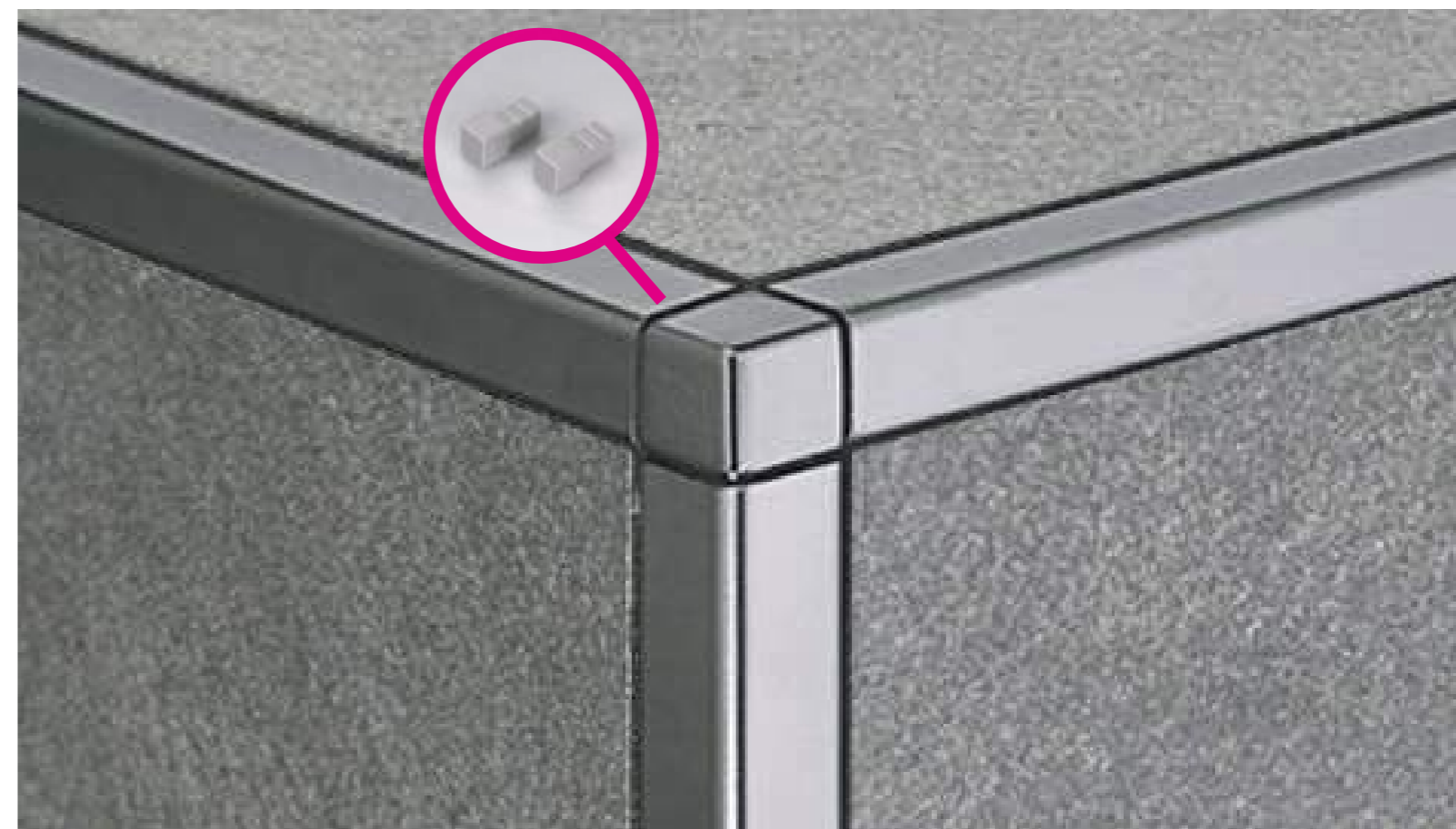

RONDALU	Finitura - Finish	Caratteristiche	EAN	Cod.	H. (mm)	L. (m)	Conf. - Carton	Min. ord.							
	Alluminio naturale natural aluminum					2,70	50	10							
									argento anodizzato satinato satin anodised silver						
	8013237044152	042 / 90	FR 5												
	8013237018504	254B / 90	FR 8												
	8013237018375	254A / 90	FR 10												
	8013237018887	254Q1 / 90	FR 12,5												
	oro anodizzato satinato satin anodised gold									2,50	50	10			
													8013237081218	254A3 / 90	10
													8013237066727	254B2 / 90	FR 8
													8013237066734	254A2 / 90	FR 10
bronzo anodizzato satinato satin anodised bronze						1,00	50	10							

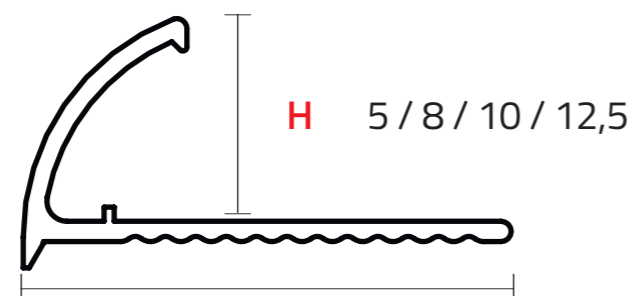

Conf. da 50 pz

Chiusura perimetrale a muro/ Wall covering edging



Protezione spigolo/ Corner protection



Chiusura perimetrale a pavimento/ Ground covering edging



Paragradino / Stair nosing



\* Profili compatibili con capsule a pagina 70  
Profiles compatible with caps on page 70

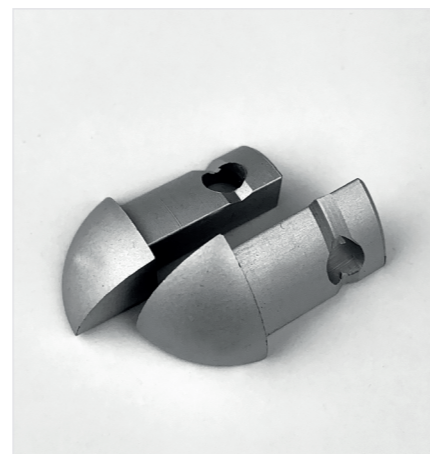

\*Capsula 2/3 vie argento 90  
\*Cap 2/3 way silver 90



CAPSULE/ CAPS

Finitura - Finish	EAN	Cod.	H. (mm)	Pz.	Min. ord.	
argento anodizzato satinato satin anodised silver	8013237079826	254H10 <span>FR</span>	10	1	10	
	8013237079833	254H12 <span>FR</span>	12,5	1	10	





Min. ord 10 pz

BLISTER

Finitura - Finish	EAN	Cod.	H. (mm)	Pz.	Min. ord.	
argento anodizzato satinato	8013237083670	254H8/BLISTER	8	2	5	
satin anodised silver	8013237083687	254H10/BLISTER	10	2	5	
	8013237138844	254H12/BLISTER	12,5	2	5	

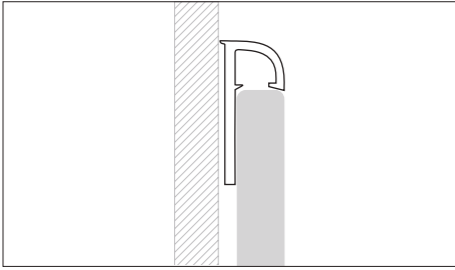

RONDALU-ECO		Finitura - Finish	Caratteristiche	EAN	Cod.	H. (mm)	L. (m)	Conf. - Carton	Min. ord.	
		Alluminio naturale natural aluminum		8013237137953	254B / F / N	FR 8		2,50	50	10
				8013237137960	254A / F / N	FR 10				
				8013237137816	254B2 / F / N	8				
				8013237137823	254A2 / F / N	10				
	argento anodizzato satinato satin anodised silver		8013237135522	254B / F / 90	FR 8		2,50	50	10	
			8013237135508	254A / F / 90	FR 10					
			8013237137830	254B2 / F / 90	8					
	titanio anodizzato satinato satin anodised titanium		8013237137847	254A2 / F / 90	10					

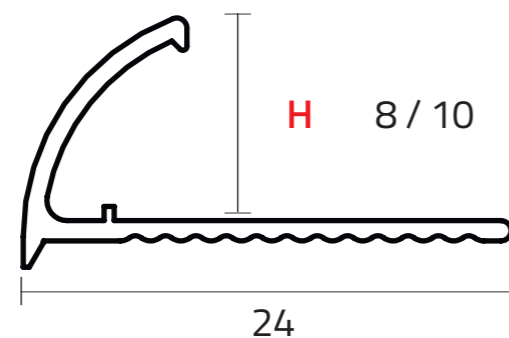



# Alluminio Anodizzato Lucido

Polished anodised Alu/ Alu Anodisé Brillant/ Alu Anodizado Brillo

## Alluminio anodizzato lucido:

I profili di protezione Arcansas sono una linea di profili in alluminio progettati per raccordare e proteggere gli angoli esterni dei rivestimenti in ceramica. Disponibili in differenti sezioni, altezze e finiture.

Ottenuti mediante estrusione dell'alluminio, prima di poter essere anodizzato, subisce un trattamento meccanico di lucidatura a specchio per eliminare ogni imperfezione tipica del processo di estrusione e conferire al profilo una finitura brillante a specchio, altamente decorativa. Viene sottoposto all'ossidazione anodica per immersione in vasche elettrolitiche e successivamente nelle vasche del colore che viene poi fissato nelle ultime vasche del lungo processo anodico, dando vita ad uno strato protettivo che protegge il colore. Arcansas garantisce uno spessore del trattamento da 5 a 10µm secondo il tipo di colore per la massima qualità di brillantezza. Arcansas impiega la lega 6063 per ottenere una colorazione brillante ed uniforme dal massimo grado di finitura estetica oltre che funzionale.

## Vantaggi:

Altamente decorativo.  
Facilmente lavorabile grazie alla duttilità di questa lega.  
Elevato aumento della resistenza alla corrosione acida, salina o agenti atmosferici rispetto all'alluminio naturale.  
Buona resistenza ai graffi (non propria dell'alluminio naturale).  
Adatto per interni ed esterni.  
Riciclabile nell'alluminio.

## Polished anodised Aluminium:

Arcansas protection profiles are designed to connect and protect the external corners and edges of ceramic tiles coverings.  
Available in different sections, heights and finishing.

Obtained by extruding aluminium, before anodization, it undergoes a mechanical mirror polishing treatment to eliminate any imperfection typical of the extrusion process and give the profile a highly decorative mirror shine finish. The anodic anodization process, done by immersion in electrolytic tanks and subsequently in the colour tanks, creates a protective layer that protects the colour itself. Arcansas guarantees a treatment thickness from 5 to 10µm according to the type of colour for the maximum quality of brilliance. Arcansas uses alloy 6063 to obtain a bright and uniform colouring with the highest degree of aesthetic as well as functional finish.

## Advantages :

Highly decorative.  
Easily workable thanks to the ductility of this alloy.  
High increase in resistance to acid, saline or weathering corrosion compared to natural aluminium.  
Good scratch resistance (not typical of natural aluminium).  
Suitable for indoors and outdoors.  
Recyclable.

## Aluminium anodisé brillant:

Les profils de protection Arcansas sont une gamme de profils en aluminium conçus pour connecter et protéger les coins externes des revêtements en céramique. Disponible en différentes sections, hauteurs et finitions.

Obtenu par extrusion d'aluminium, avant d'être anodisé, il subit un traitement mécanique de polissage miroir pour éliminer toute imperfection typique du processus d'extrusion et conférer au profilé une finition miroir hautement décorative. Il est soumis à une oxydation anodique par immersion dans des réservoirs électrolytiques puis dans les réservoirs de couleur qui est ensuite fixée dans les derniers réservoirs du long processus anodique, créant une couche protectrice qui protège la couleur. Arcansas garantit une épaisseur de traitement de 5 à 10µm selon le type de couleur pour une qualité de brillance maximale. Arcansas utilise l'alliage 6063 afin d'obtenir une coloration brillante et uniforme pour une finition hautement esthétique et fonctionnelle.

## Avantages :

Très décoratif.  
Facile à travailler grâce à la ductilité de cet alliage.  
Grande augmentation de la résistance à la corrosion acide, saline ou aux intempéries par rapport à l'aluminium naturel.  
Bonne résistance aux rayures (non typique de l'aluminium naturel).  
Convient pour l'intérieur et l'extérieur.  
Recyclable en aluminium.

## Aluminio anodizado brillo:

Los perfiles de protección Arcansas son una línea de perfiles de aluminio diseñados para conectar y proteger las esquinas externas de los revestimientos cerámicos. Disponible en diferentes secciones, alturas y acabados.

Obtenido por extrusión de aluminio, antes de ser anodizado, se somete a un tratamiento mecánico de pulido espejo para eliminar cualquier imperfección típica del proceso de extrusión y darle al perfilé un acabado de brillo espejo altamente decorativo. Se somete a oxidación anódica por inmersión en tanques electrolíticos y posteriormente en los tanques de color que luego se fijan en los últimos tanques del largo proceso anódico, creando una capa protectora que protege el color. Arcansas garantiza un espesor de tratamiento de 5 a 10 µm según el tipo de color para obtener la máxima calidad de brillo. Arcansas utiliza la aleación 6063 para obtener una coloración brillante y uniforme con el más alto grado de acabado estético y funcional.

## Ventajas :

Altamente decorativo.  
Fácilmente mecanizable gracias a la ductilidad de esta aleación.  
Alto aumento de la resistencia a la corrosión ácida, salina o por agentes atmosféricos en comparación con el aluminio natural.  
Buena resistencia al rayado (no es típico del aluminio natural).  
Adecuado para interiores y exteriores.  
Reciclabile en el aluminio.

ALUCER	Finitura - Finish	Caratteristiche	EAN	Cod.	H. (mm)	L. (m)	Conf. - Carton	Min. ord.				
		argento lucido polished silver				2,50	50	10				
									8013237133337	061E / 93	FR	4,5
									8013237029777	061F9 / 93	FR	8
									8013237144067	061G8 / 93	FR	11
									8013237028398	061G / 93	FR	10
									8013237133344	061H / 93	FR	12,5
									8013237135478	061F9 / F/93		8
									8013237135492	061G / F/93		10
									8013237137922	061F92 / F/93		8
									8013237137908	061G2 / F/93		10
						2,50	50	10				
						1,00	50	10				

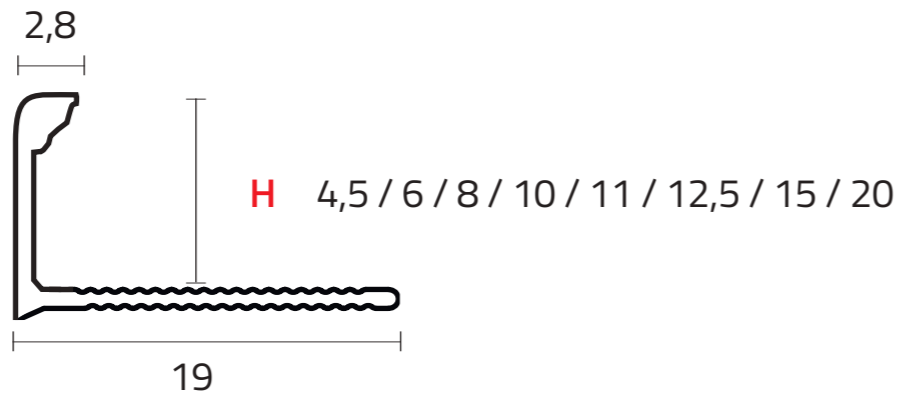

Listello decorativo/ Decorative listello



Protezione spigolo/ Corner protection



Chiusura perimetrale a muro/ Wall covering edging



Chiusura perimetrale a pavimento/ Ground covering edging



CUBALU	Finitura - Finish	Caratteristiche	EAN	Cod.	H. (mm)	L. (m)	Conf. Carton	Min. ord.
	argento lucido bright silver		8013237044183	041 / 93	10	2,50	50	10
			8013237046699	043 / 93	12,5			
	ramato lucido bright copper					2,50	50	10
	titanio lucido bright titanium			8013237052690	041 / 95			
	nero lucido bright black		8013237052898	043 / 95	12,5		50	10

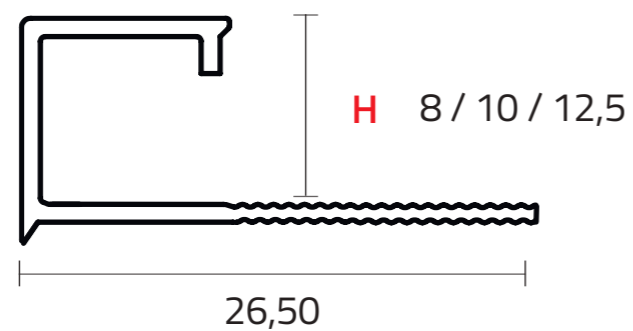

Chiusura perimetrale a muro / Wall covering edging



Protezione spigolo / Corner protection



Chiusura perimetrale a pavimento / Ground covering edging





Paragradino / Stair nosing



\* Profili compatibili con capsule a pagina 82  
Profiles compatible with caps on page 82

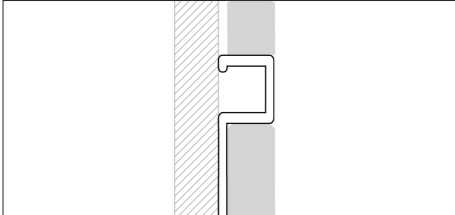

ALUSQUARE	Finitura - Finish	Caratteristiche	EAN	Cod.	H. (mm)	L. (m)	Conf. Carton	Min. ord.
	 argento lucido bright silver		8013237135591	040/S/93	8	2,50	50	10
			8013237135546	041/S/93	10		50	10
			8013237135577	043/S/93	12,5		50	10
			8013237137854	041D/S/93	10	1,00	50	10
			8013237137861	043D/S/93	12,5		50	10

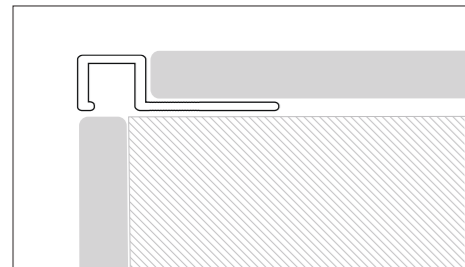
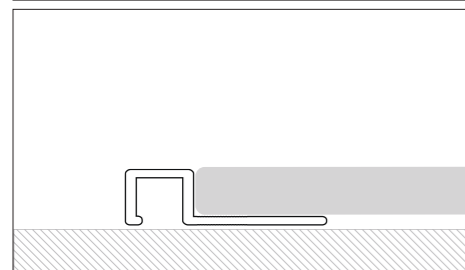
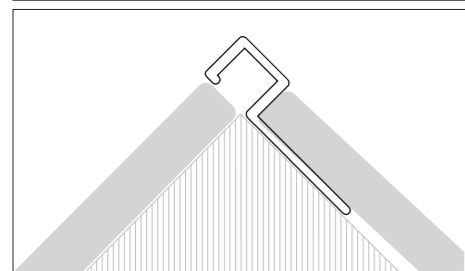
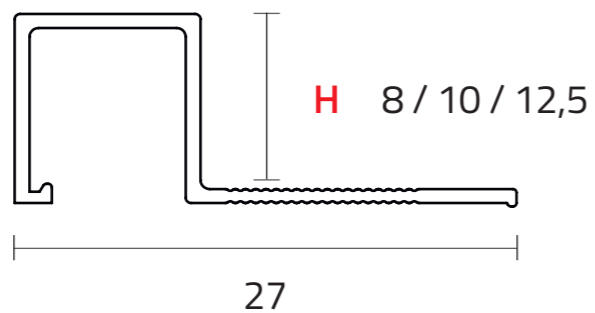

Listello decorativo/ Decorative listello



Protezione spigolo/ Corner protection



Chiusura perimetrale a muro/ Wall covering edging



 \* Profili compatibili con capsule a pagina 82  
Profiles compatible with caps on page 82



\*Capsula 2/3 vie  
\*Cap 2/3 way



**CAPSULE/ CAPS**

Finitura - Finish	EAN	Cod.	H. (mm)	Pz.	Min. ord.
argento lucido polished silver	8013237079895	<b>258BH10</b>	10	1	10
	8013237079901	<b>258BH12</b>	12,5	1	10



Min. ord 10 pz

**BLISTER**

Finitura - Finish	EAN	Cod.	H. (mm)	Pz.	Min. ord.
argento lucido polished silver	8013237138820	<b>258BH10/BLISTER</b>	10	2	5
	8013237138875	<b>258BH12/BLISTER</b>	12,5	2	5

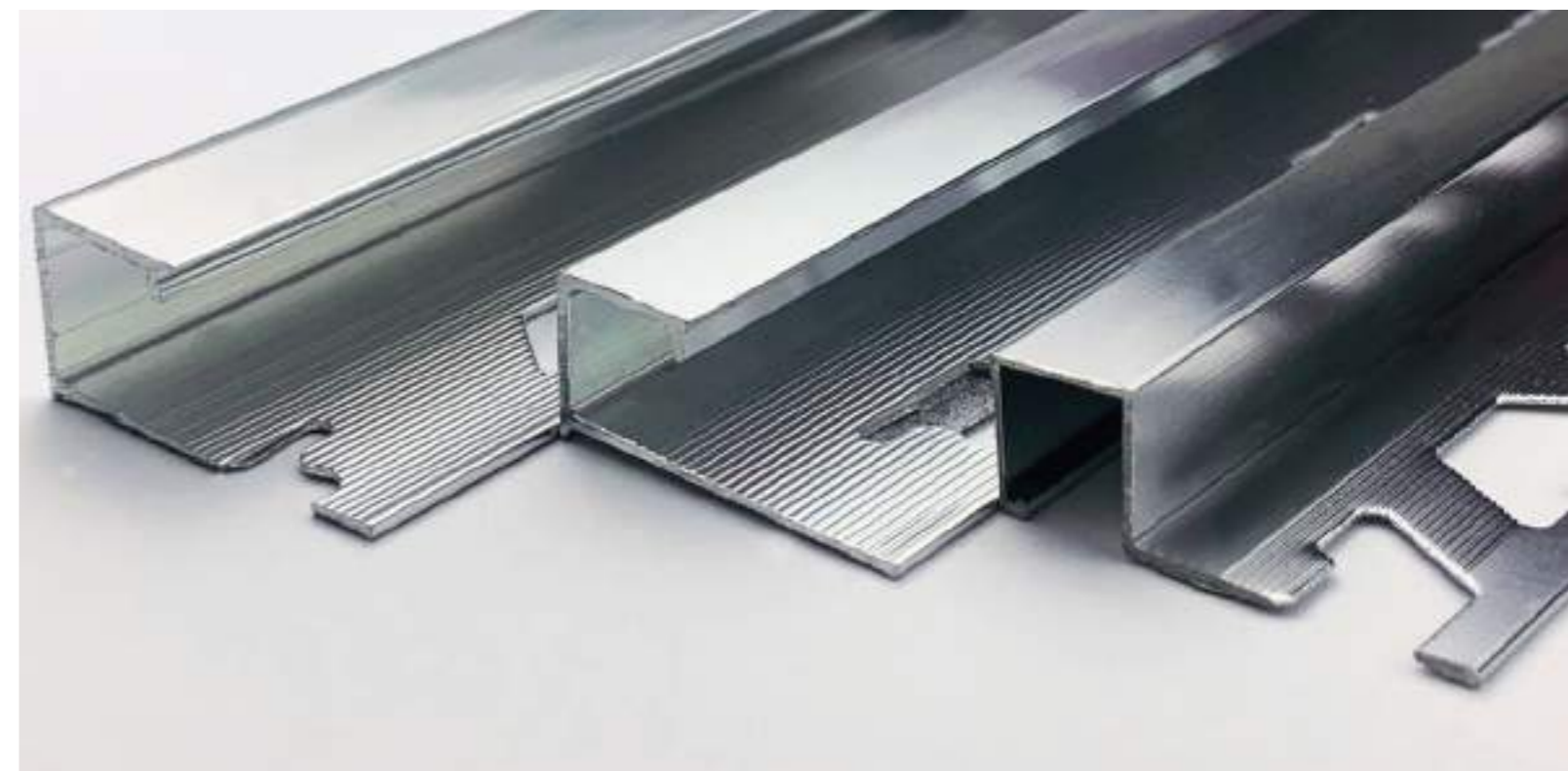

RONDALU	Finitura - Finish	Caratteristiche	EAN	Cod.	H. (mm)	L. (m)	Conf. - Carton	Min. ord.
	 argento anodizzato lucido polished anodised silver	   	8013237044169	042 / 93	5	2,70	50	10
			8013237018566	254B / 93	8		50	10
			8013237254131	254A / 93	10		50	10
			8013237018917	254Q1 / 93	12,5		50	10
	 oro anodizzato lucido polished anodised gold	   	8013237081225	254A3 / 93	10	2,70	50	10
			8013237066703	254B2 / 93	8		50	10
			8013237066710	254A2 / 93	10		50	10
			8013237018931	254Q1 / 94	12,5		50	10
	 ramato anodizzato lucido polished anodised copper	  	8013237052652	254A / 95	10	2,70	50	10
			8013237066826	254A2 / 95	10		50	10
	 titanio anodizzato lucido polished anodised titanium	  	8013237066833	254Q1A / 95	12,5	1,00	50	10
 nero anodizzato lucido polished anodised black	 							

Chiusura perimetrale a muro/ Wall covering edging



Protezione spigolo/ Corner protection



Chiusura perimetrale a pavimento/ Ground covering edging



Paragradino/ Stair nosing



\* Profili compatibili con capsule a pagina 86  
Profiles compatible with caps on page 86



\* Capsula 2/3 vie argento 93  
\* Cap 2/3 way silver 93



CAPSULE/ CAPS

Finitura - Finish	EAN	Cod.	H. (mm)	Pz.	Min. ord.
argento lucido bright silver	8013237079857	<b>254BH10</b>	10	1	10
	8013237079864	<b>254BH12</b>	12,5	1	10



Min. ord 10 pz

BLISTER

Finitura - Finish	EAN	Cod.	H. (mm)	Pz.	Min. ord.
argento lucido bright silver	8013237083663	<b>254BH8/BLISTER</b>	8	2	5
	8013237083694	<b>254BH10/BLISTER</b>	10	2	5





# Alluminio Anodizzato Spazzolato

## Anodised Brushed Alu/Alu Anodisé Brossé/ Alu Anodizado Cepillado

**Alluminio anodizzato spazzolato:**  
I profili di protezione Arcansas sono una linea di profili in alluminio progettati per raccordare e proteggere gli angoli esterni dei rivestimenti in ceramica. Disponibili in differenti sezioni, altezze e finiture.

Prima di poter essere anodizzato, subisce un trattamento meccanico di speciale spazzolatura in acqua per eliminare ogni imperfezione tipica del processo di estrusione e conferire al profilo una finitura spazzolata e dai riflessi lucidi, altamente decorativa. Viene sottoposto all'ossidazione anodica per immersione in vasche elettrolitiche e successivamente nelle vasche del colore che viene poi fissato nelle ultime vasche del lungo processo anodico, dando vita ad uno strato protettivo che protegge il colore. Arcansas garantisce uno spessore del trattamento da 10 a 15 µm secondo il tipo di colore per la massima qualità di protezione. Arcansas impiega la lega 6060 per ottenere una colorazione spazzolata e dai riflessi variegati per il massimo grado di finitura estetica oltre che funzionale.

**Vantaggi:**  
Altamente decorativo.  
Facilmente lavorabile grazie alla duttilità di questa lega.  
Elevato aumento della resistenza alla corrosione acida, salina o agenti atmosferici rispetto all'alluminio naturale.  
Buona resistenza ai graffi (non propria dell'alluminio naturale).  
Adatto per interni ed esterni.  
Riciclabile nell'alluminio.

**Anodised Brushed Aluminum:**  
Arcansas protection profiles are designed to connect and protect the external corners and edges of ceramic tiles coverings. Available in different sections, heights and finishing.

Before being anodised, it undergoes a mechanical treatment of special brushing in water to eliminate any imperfection typical of the extrusion process and give the profile a highly decorative brushed finish with glossy reflections. It is then dipped in the electrolytic tanks for anodic oxidation and subsequently in the colour tanks to create a protective layer that protects the profile. For the maximum quality of brilliance, Arcansas guarantees a treatment thickness of 10 to 15 µm depending to the colour type. For the maximum degree of aesthetic as well as functional finish, Arcansas uses the alloy 6060 to obtain a brushed color and variegated reflections.

**Advantages :**  
Highly decorative.  
Easily workable thanks to the ductility of this alloy.  
High increase in resistance to acid, saline or weathering corrosion compared to natural aluminum.  
Good scratch resistance (not typical of natural aluminum).  
Suitable for indoors and outdoors.  
Recyclable.

**Aluminium Anodisé Brossé:**  
Les profils de protection Arcansas sont une gamme de profils en aluminium conçus pour connecter et protéger les coins externes des revêtements en céramique. Disponible en différentes sections, hauteurs et finitions.

Avant d'être anodisé, il subit un traitement mécanique de broyage spécial à l'eau pour éliminer toute imperfection typique du processus d'extrusion et donner au profilé une finition brossée très décorative aux reflets brillants. Il est soumis à une oxydation anodique par immersion dans des réservoirs électrolytiques puis dans les réservoirs de couleur ou celle-ci est fixée dans les derniers réservoirs de ce long processus anodique, créant une couche protectrice qui protège la couleur. Arcansas garantit une épaisseur de traitement de 10 à 15 µm selon le type de couleur pour une protection de la plus grande qualité. Arcansas utilise l'alliage 6060 pour obtenir une couleur brossée et des reflets moirés avec un degré maximal de finition esthétique et fonctionnelle.

**Avantages :**  
Très décoratif.  
Facile à travailler grâce à la ductilité de cet alliage.  
Grande augmentation de la résistance à la corrosion acide, saline ou aux intempéries par rapport à l'aluminium naturel.  
Bonne résistance aux rayures (non typique de l'aluminium naturel).  
Convient pour l'intérieur et l'extérieur.  
Recyclable en aluminium.

**Aluminio Anodizado Cepillado:**  
Los perfiles de protección Arcansas son una línea de perfiles de aluminio diseñados para conectar y proteger las esquinas externas de los revestimientos cerámicos. Disponible en diferentes secciones, alturas y acabados.

Antes de ser anodizado, se somete a un tratamiento mecánico de cepillado especial en agua para eliminar cualquier imperfección típica del proceso de extrusión y darle al perfil un acabado cepillado con reflejos brillantes altamente decorativo. Se somete a oxidación anódica por inmersión en tanques electrolíticos y posteriormente en tanques de color que luego se fijan en los últimos tanques del largo proceso anódico, creando una capa protectora que protege el color. Arcansas garantiza un espesor de tratamiento de 10 a 15 µm de acuerdo con el tipo de color para la más alta calidad de protección. Arcansas utiliza la aleación 6060 para obtener un color cepillado y reflejos variados para obtener el máximo grado de acabado estético además que funcional.

**Vantajas :**  
Altamente decorativo.  
Fácilmente mecanizable gracias a la ductilidad de esta aleación.  
Alto aumento de la resistencia a la corrosión ácida, salina o por agentes atmosféricos en comparación con el aluminio natural.  
Buena resistencia al rayado (no es típico del aluminio natural).  
Adecuado para interiores y exteriores.  
Reciclabile en el aluminio.



# Alluminio Verniciato

Powder Coated alu/ Alu verni/ Alu pintado

## Alluminio verniciato:

I profili di protezione Arcansas sono una linea di profili in alluminio progettati per raccordare e proteggere gli angoli esterni dei rivestimenti in ceramica. Disponibili in differenti sezioni, altezze e finiture.

Ottenuti per estrusione e successiva verniciatura a polveri epossidiche elettrostatiche invrudite a forno, sono precedentemente trattati con uno speciale procedimento di sgrassaggio e preverniciatura per conferire resistenza e massima adesione alla successiva verniciatura. Arcansas garantisce uno spessore minimo di 80 micron e una brillantezza di 100 gloss. Disponibile nei colori bianco RAL 9003 e nero RAL 9005.

## Vantaggi:

Finitura estetica di pregio.  
Resistente ai raggi ultravioletti.  
Resistente ai graffi.  
Riciclabile.

## Powder Coated Aluminum :

Arcansas protection profiles are designed to connect and protect the external corners and edges of ceramic tiles coverings. Available in different sections, heights and finishing.

Obtained by extrusion and subsequent painting with electrostatic epoxy powders hardened in the oven, they are previously treated with a special degreasing and pre-painting process to give resistance and maximum adhesion to the subsequent painting. Arcansas guarantees a minimum thickness of 80 microns and a gloss of 100 gloss. Available in white RAL 9003 and black RAL 9005.

## Advantages:

Fine aesthetic finish.  
Resistant to ultraviolet rays.  
Scratch resistant.  
Recyclable.

## Aluminium Verni :

Les profils de protection Arcansas sont une gamme de profils en aluminium conçus pour connecter et protéger les coins externes des revêtements en céramique. Disponible en différentes sections, hauteurs et finitions.

Obtenu par extrusion et ultérieur vernissage avec des poudres époxy électrostatiques durcies au four, ils sont préalablement traités par un procédé spécial de dégraissage et de pré-peinture pour donner une résistance et une adhérence maximale à la peinture suivante. Arcansas garantit une épaisseur minimale de 80 microns et un brillant de 100 brillants. Disponible en blanc RAL 9003 et noir RAL 9005.

## Les avantages:

Finition esthétique de haute qualité.  
Résistant aux rayons ultraviolets.  
Résistant aux rayures.  
Recyclable.



## Aluminio Pintado :

Los perfiles de protección Arcansas son una línea de perfiles de aluminio diseñados para conectar y proteger las esquinas externas de los revestimientos cerámicos. Disponible en diferentes secciones, alturas y acabados.

Obtenidos por extrusión y pintura sucesiva con polvos epoxídicos electrostáticos endurecidos en el horno, se tratan previamente con un proceso especial de desengrasado y pre-pintura para dar resistencia y máxima adhesión a la pintura posterior. Arcansas garantiza un espesor mínimo de 80 micras y un brillo de 100 gloss. Disponible en los colores blanco RAL 9003 y negro RAL 9005.

## Ventajas:

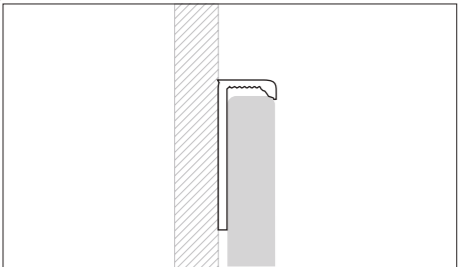
Acabado estético de alta calidad.  
Resistente a los rayos ultravioleta.  
Resistente a los arañazos.  
Reciclabile.

ALUCER	Finitura - Finish	Caratteristiche	EAN	Cod.	H. (mm)	L. (m)	Conf. - Carton	Min. ord.
	 New nero spazzolato brushed black		8013237144968	061F9 / 63	FR 8	2,50	50	10
			8013237144975	061G / 63	FR 10	2,50	50	10
			8013237144982	061G8 / 63	FR 11	2,50	50	10

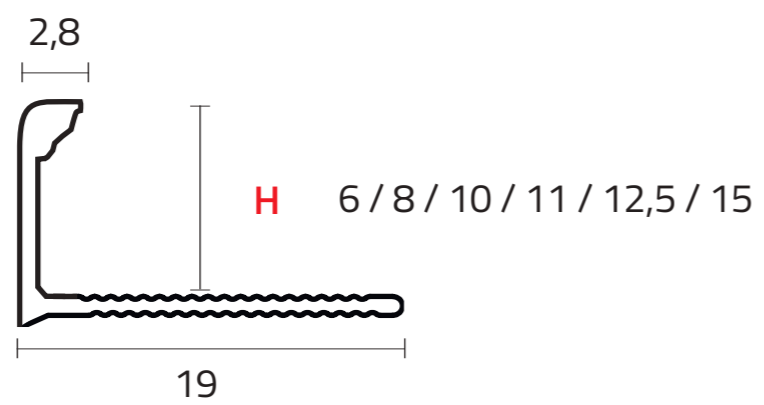
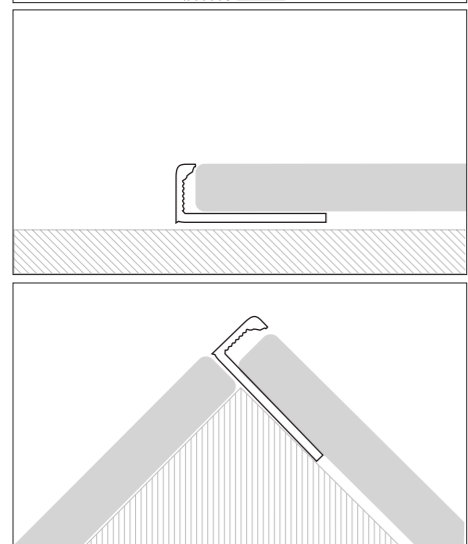

Chiusura perimetrale a muro/ Wall covering edging



Chiusura perimetrale a pavimento/ Ground covering edging



CUBALU	Finitura - Finish	Caratteristiche	EAN	Cod.	H. (mm)	L. (m)	Conf. Carton	Min. ord.
		D	8013237052997	041 / 99S	10	2,50	50	10
			8013237052881	043 / 99S	12,5			
		D	8013237052706	041 / 96	FR 10	2,50	50	10
			8013237052904	043 / 96	FR 12,5			
		D	8013237065331	041 / 63	FR 10	2,50	50	10
			8013237065348	043 / 63	FR 12,5			
		D	8013237070144	041 / 66	10	2,50	50	10
			8013237070151	043 / 66	12,5			
		D	8013237070274	041 / 68	FR 10	2,50	50	10
		D				2,50	50	10
		D				2,50	50	10
		D	8013237081362	041 / 61	10	2,50	50	10
		D	8013237064501	041 / 62	10	2,50	50	10
			8013237064518	043 / 62	FR 12,5			

\* Profili compatibili con capsule a pagina 96-98  
Profiles compatible with caps on page 96-98

Chiusura perimetrale a muro/ Wall covering edging



Protezione spigolo/ Corner protection



Chiusura perimetrale a pavimento/ Ground covering edging



Paragradino/ Stair nosing





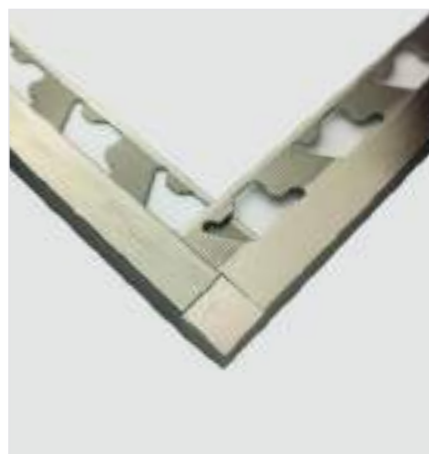

\*Capsula 2/3 vie  
\*Cap 2/3 way

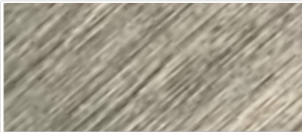

**CAPSULE/ CAPS**

Finitura - Finish	EAN	Cod.	H. (mm)	Pz.	Min. ord.	
 titanio spazzolato brushed titanium						



Min. ord 10 pz

**BLISTER**

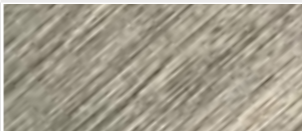
Finitura - Finish	EAN	Cod.	H. (mm)	Pz.	Min. ord.	
 titanio spazzolato brushed titanium	8013237140236	<b>258H10/T/BL</b>	10	2	5	
	8013237140229	<b>258H12/T/BL</b>	12,5	2	5	





\* Capsula 2/3 vie  
\* Cap 2/3 way



### CAPSULE/ CAPS

Finitura - Finish	EAN	Cod.	H. (mm)	Pz.	Min. ord.	
 ramato spazzolato brushed copper						



Min. ord 10 pz

### BLISTER

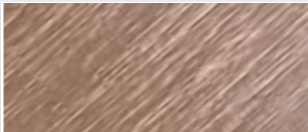
Finitura - Finish	EAN	Cod.	H. (mm)	Pz.	Min. ord.	
 ramato spazzolato brushed copper	8013237140243	<b>258H10/R/BL</b>	10	2	5	
	8013237140250	<b>258H12/R/BL</b>	12,5	2	5	



RONDALU	Finitura - Finish	Caratteristiche	EAN	Cod.	H. (mm)	L. (m)	Conf. - Carton	Min. ord.		
		ramato anodizzato spazzolato brushed anodised copper	B	B	8013237052942	254A / 99S	10	2,70	50	10
				B	8013237052843	254Q1 / 99S	12,5			
		titanio anodizzato spazzolato brushed anodised titanium	B	B	8013237052669	254A / 96	FR 10	2,70	50	10
				B	8013237052867	254Q1 / 96	FR 12,5			
		nero anodizzato spazzolato brushed anodised black	B	B	8013237066819	254A2 / 96	FR 10	1,00	50	10
				B	8013237066840	254Q1A / 96	12,5			
		nero anodizzato spazzolato brushed anodised black	B	B	8013237065317	254A / 63	FR 10	2,70	50	10
				B	8013237065324	254Q1 / 63	FR 12,5			
		oro anodizzato spazzolato spiga brushed herringbone anodised gold	B	B	8013237070175	254A / 66	10	2,70	50	10
				B	8013237070199	254Q1 / 66	12,5			
		champagne anodizzato spazzolato spiga brushed herringbone anodised champagne	B	B	8013237070311	254A / 68	10	2,70	50	10
				B						
		bianco verniciato powder coated white	B	B	8013237137793	254B2 / 51	8	1,00	50	10
				B	8013237018467	254B / 51	8			
		nero verniciato powder coated black	B	B	8013237018269	254A / 51	10	2,70	50	10
				B	8013237064457	254A / 62	10			
		nero verniciato powder coated black	B	B	8013237066857	254A2 / 62	10	2,70	50	10
				B	8013237066871	254Q1A / 62	12,5			

Chiusura perimetrale a muro/ Wall covering edging



Protezione spigolo/ Corner protection



Chiusura perimetrale a pavimento/ Ground covering edging



Paragradino/ Stair nosing



\* Profili compatibili con capsule a pagina 102  
Profiles compatible with caps on page 102



\*Capsula 2/3 vie  
\*Cap 2/3 way



\*Capsula 2/3 vie  
\*Cap 2/3 way

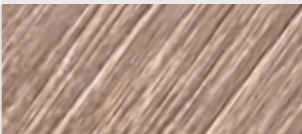

CAPSULE/ CAPS

Finitura - Finish	EAN	Cod.	H. (mm)	Pz.	Min. ord.	€/pz
 ramato spazzolato brushed copper						

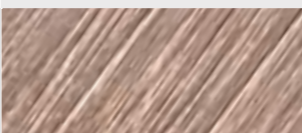

BLISTER

Finitura - Finish	EAN	Cod.	H. (mm)	Pz.	Min. ord.
 ramato spazzolato brushed copper	8013237140281	<b>254H10/R/BL</b>	10	2	5
	8013237140298	<b>254H12/R/BL</b>	12,5	2	5

CAPSULE/ CAPS

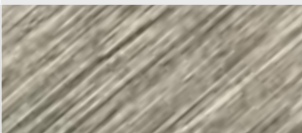
Finitura - Finish	EAN	Cod.	H. (mm)	Pz.	Min. ord.
 titanio spazzolato brushed titanium					

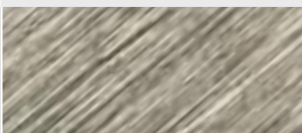

BLISTER

Finitura - Finish	EAN	Cod.	H. (mm)	Pz.	Min. ord.
 titanio spazzolato brushed titanium	8013237140267	<b>254H10/T/BL</b>	10	2	5
	8013237140274	<b>254H12/T/BL</b>	12,5	2	5



# Alluminio effetto Pietra

Stone Finish Alu/ Alu Effet Pierre/ Alu Efecto Piedra

## Alluminio effetto pietra:

I profili di protezione Arcansas sono una linea di profili in alluminio progettati per raccordare e proteggere gli angoli esterni dei rivestimenti in ceramica. Disponibili in differenti sezioni, altezze e finiture.

Ottenuti per estrusione e successiva verniciatura a polveri epossidiche elettrostatiche, sono precedentemente trattati con uno speciale procedimento di sgrassaggio e pre-verniciatura per conferire resistenza e massima adesione alla successiva verniciatura.

Queste finiture si adattano perfettamente alle nuove tendenze di arredamento delle piastrelle ceramiche effetto pietra, con finiture opache e naturali.

Arcansas garantisce uno spessore minimo di 80 micron, disponibile nei colori pietra naturali.

## Vantaggi:

Finitura estetica di pregio.  
Resistente ai raggi ultravioletti.  
Molto resistente ai graffi.  
Riciclabile nell'alluminio.

## Stone Finish Aluminum:

Arcansas protection profiles are designed to connect and protect the external corners and edges of ceramic tiles coverings. Available in different sections, heights and finishing.

Obtained by extrusion and subsequent painting with electrostatic epoxy powders, they are previously treated with a special degreasing and pre-painting process to give resistance and maximum adhesion to the subsequent painting.

These finishes are perfectly suited to the new furnishing trends of stone effect ceramics, with matte and natural finishes.

Arcansas guarantees a minimum thickness of 80 microns, available in natural stone colors.

## Advantages:

Fine aesthetic finish.  
Resistant to ultraviolet rays.  
Very resistant to scratches.  
Recyclable.

## Aluminium Effet Pierre:

Les profilés de protection Arcansas sont une gamme de profilés en aluminium conçus pour connecter et protéger les coins externes des revêtements en céramique. Disponible en différentes sections, hauteurs et finitions.

Obtenus par extrusion et peinture ultérieure avec des poudres époxy électrostatiques, ils sont préalablement traités par un procédé spécial de dégraissage et de pré-peinture pour donner une résistance et une adhérence maximale à la peinture suivante.

Ces finitions sont parfaitement adaptées aux nouvelles tendances d'ameublement du céramique effet pierre, avec des finitions mates et naturelles.

Arcansas garantit une épaisseur minimale de 80 microns, disponible en couleurs de pierre naturelle.

## Avantages:

Finition esthétique de haute qualité.  
Résistant aux rayons ultraviolets.  
Très résistant aux rayures.  
Recyclable.

## Aluminio Efecto Piedra:

Los perfiles de protección Arcansas son una línea de perfiles de aluminio diseñados para conectar y proteger las esquinas externas de los revestimientos cerámicos. Disponible en diferentes secciones, alturas y acabados.

Obtenidos por extrusión y pintura sucesiva con polvos epoxídicos electrostáticos, se tratan previamente con un proceso especial de desengrasado y pre-pintura para dar resistencia y máxima adhesión a la pintura posterior.

Estos acabados se adaptan perfectamente a las nuevas tendencias de decoración de cerámica con efecto de piedra, con acabados mate y natural.

Arcansas garantiza un espesor mínimo de 80 micras, disponible en colores de piedra natural.

## Ventajas:

Acabado estético de alta calidad.  
Resistente a los rayos ultravioleta.  
Muy resistente a los arañazos.  
Reciclabile.

ALUCER	Finitura - Finish	Caratteristiche	EAN	Cod.	H. (mm)	L. (m)	Conf. - Carton	Min. ord.
	verniciato effetto pietra ruggine stone finishing painting rust	B	8013237145316	061G8 / 100		2,50	10	10
	verniciato effetto pietra beige stone finishing painting beige		8013237145323	061G8 / 101				
	verniciato effetto pietra sabbia stone finishing painting sand	B	8013237145330	061G8 / 102		2,50	10	10
	verniciato effetto pietra cemento stone finishing painting concrete		8013237145347	061G8 / 103				
	verniciato effetto pietra fumo di Londra stone finishing painting London smoke	B	8013237145354	061G8 / 104		2,50	10	10
	verniciato effetto pietra antracite stone finishing painting anthracite		8013237145361	061G8 / 105				

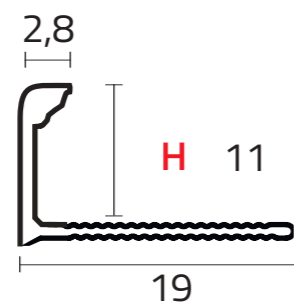

Listello decorativo/ Decorative listello



Protezione spigolo/ Corner protection



Chiusura perimetrale a muro/ Wall covering edging



Paragradino/ Stair nosing



CUBALU	Finitura - Finish	Caratteristiche	EAN	Cod.	H. (mm)	L. (m)	Conf. Carton	Min. ord.
			8013237143640	040D/101	8	2,50	10	10
			8013237142865	041/101	FR 10			
			8013237145026	041E/101	11			
			8013237142926	043/101	FR 12,5			
			8013237143657	040D/102	8	2,50	10	10
			8013237142872	041/102	FR 10			
			8013237145033	041E/102	11			
			8013237142933	043/102	FR 12,5			
			8013237143664	040D/103	8	2,50	10	10
			8013237142889	041/103	FR 10			
			8013237145040	041E/103	11			
			8013237142940	043/103	FR 12,5			
			8013237143688	040D/105	8	2,50	10	10
			8013237142902	041/105	FR 10			
			8013237145064	041E/105	11			
			8013237142964	043/105	FR 12,5			
			8013237143671	040D/104	8	2,50	10	10
			8013237142896	041/104	FR 10			
			8013237145057	041E/104	11			
			8013237142957	043/104	FR 12,5			
			8013237143633	040D/100	8	2,50	10	10
			8013237142858	041/100	FR 10			
			8013237145019	041E/100	11			
			8013237142919	043/100	FR 12,5			

Chiusura perimetrale a muro/ Wall covering edging



Protezione spigolo/ Corner protection



Chiusura perimetrale a pavimento/ Ground covering edging



Paragradino/ Stair nosing



\* Profili compatibili con capsule a pagina 110-112-114  
Profiles compatible with caps on page 110-112-114



\*Terminale  
1/2 vie



\*Terminale  
1/2 vie



CAPSULE/ CAPS

Finitura - Finish	EAN	Cod.	Min. ord.	H. (mm)	Pz.	
 verniciato effetto pietra beige stone finishing painting beige						



Min. ord 10 pz

BLISTER

Finitura - Finish	EAN	Cod.	Min. ord.	H. (mm)	Pz.	
 verniciato effetto pietra beige stone finishing painting beige	8013237144807	258H8/101/BL	5	8	2	
	8013237144609	258H10/101/BL <span>FR</span>	5	10	2	
	8013237145156	258H11/101/BL	5	11	2	
	8013237144616	258H12/101/BL <span>FR</span>	5	12,5	2	

CAPSULE/ CAPS

Finitura - Finish	EAN	Cod.	Min. ord.	H. (mm)	Pz.	
 verniciato effetto pietra sabbia stone finishing painting sand						



Min. ord 10 pz

BLISTER

Finitura - Finish	EAN	Cod.	Min. ord.	H. (mm)	Pz.	
 verniciato effetto pietra sabbia stone finishing painting sand	8013237144814	258H8/102/BL	5	8	2	
	8013237144623	258H10/102/BL <span>FR</span>	5	10	2	
	8013237145163	258H11/102/BL	5	11	2	
	8013237144630	258H12/102/BL <span>FR</span>	5	12,5	2	





\*Terminale  
1/2 vie



\*Terminale  
1/2 vie



### CAPSULE/ CAPS

Finitura - Finish	EAN	Cod.	Min. ord.	H. (mm)	Pz.	
 verniciato effetto pietra cemento stone finishing painting concrete						



### BLISTER

Finitura - Finish	EAN	Cod.	Min. ord.	H. (mm)	Pz.	
 verniciato effetto pietra cemento stone finishing painting concrete	8013237144821	258H8/103/BL	5	8	2	
	8013237144647	258H10/103/BL <span>FR</span>	5	10	2	
	8013237145170	258H11/103/BL	5	11	2	
	8013237144654	258H12/103/BL <span>FR</span>	5	12,5	2	

### CAPSULE/ CAPS

Finitura - Finish	EAN	Cod.	Min. ord.	H. (mm)	Pz.	
 verniciato effetto pietra antracite stone finishing painting anthracite						



### BLISTER

Finitura - Finish	EAN	Cod.	Min. ord.	H. (mm)	Pz.	
 verniciato effetto pietra antracite stone finishing painting anthracite	8013237144845	258H8/105/BL	5	8	2	
	8013237144685	258H10/105/BL <span>FR</span>	5	10	2	
	8013237145194	258H11/105/BL	5	11	2	
	8013237144692	258H12/105/BL <span>FR</span>	5	12,5	2	



\*Terminale  
1/2 vie

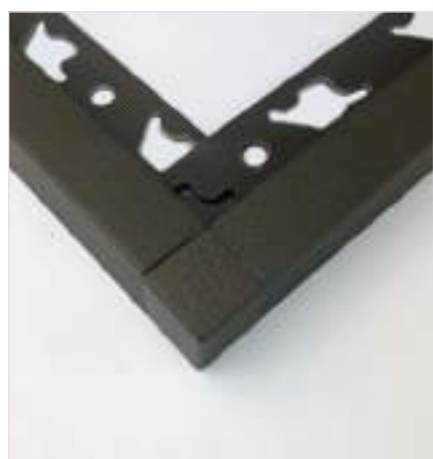

\*Terminale  
1/2 vie



### CAPSULE/ CAPS

Finitura - Finish	EAN	Cod.	Min. ord.	H. (mm)	Pz.	
 verniciato effetto pietra fumo di londra stone finishing painting london smoke						

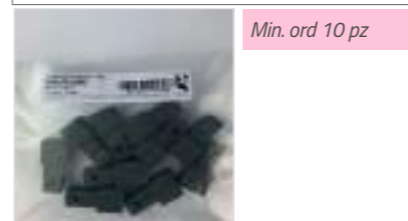

### BLISTER

Finitura - Finish	EAN	Cod.	Min. ord.	H. (mm)	Pz.	
 verniciato effetto pietra fumo di londra stone finishing painting london smoke	8013237144838	258H8/104/BL	5	8	2	
	8013237144708	258H10/104/BL <span>FR</span>	5	10	2	
	8013237145200	258H11/104/BL	5	11	2	
	8013237144715	258H12/104/BL <span>FR</span>	5	12,5	2	

### CAPSULE/ CAPS

Finitura - Finish	EAN	Cod.	Min. ord.	H. (mm)	Pz.	
 verniciato effetto pietra ruggine stone finishing painting rust						



### BLISTER

Finitura - Finish	EAN	Cod.	Min. ord.	H. (mm)	Pz.	
 verniciato effetto pietra ruggine stone finishing painting rust	8013237144791	258H8/100/BL	5	8	2	
	8013237144661	258H10/100/BL <span>FR</span>	5	10	2	
	8013237145187	258H11/100/BL	5	11	2	
	8013237144678	258H12/100/BL <span>FR</span>	5	12,5	2	



# PVC Satinato

Satin PVC/ PVC satiné/PVC satinado

**PVC Satinato:**

i profili di protezione Arcansas sono una linea di profili progettati per raccordare e proteggere gli angoli esterni dei rivestimenti in ceramica. Disponibili in differenti sezioni, altezze e colori.

Ottenuti per estrusione plastica, i profili in PVC Arcansas sono colorati in massa. Non cambiano colore se graffiati. Rappresentano la soluzione ideale per DIYers grazie alla versatilità e alla facilità di utilizzo. Disponibile in molteplici varietà di colore.

**Vantaggi:**

Colorato in massa, non perde il colore se graffiato.  
Grande disponibilità di colori.  
Facilità d'uso: tagliabile con taglierino o forbici.  
Buona resistenza meccanica e ai raggi UV.  
Durata nel tempo.  
Prezzo competitivo.  
Riciclabile nella plastica.

**Satin PVC:**

Arcansas protection profiles are designed to connect and protect the external corners and edges of ceramic tiles coverings. Available in different sections, heights and colours. Obtained by plastic extrusion, AR-CANSAS profiles are mass coloured. They do not change colour if scratched.

They represent the ideal solution for DIYers thanks to their versatility and ease of use. Available in several colour nuances.

**Advantages:**

Mass-coloured, does not lose colour if scratched.  
Wide range of colours.  
Ease of use: can be cut with a cutter or scissors.  
Good mechanical and UV resistance  
Durability.  
Competitive price.  
Recyclable.

**PVC satiné:**

Les profilés de protection Arcansas sont une gamme de profilés conçus pour connecter et protéger les coins externes du revêtement en carrelage. Disponible en différentes sections, hauteurs et couleurs. Obtenus par extrusion du plastique, les profilés PVC Arcansas sont colorés en masse. Ils ne changent pas de couleur s'ils sont rayés.

Ils représentent la solution idéale pour les bricoleurs grâce à leur polyvalence et leur facilité d'utilisation. Disponible en plusieurs variétés de couleurs.

**Avantages:**

Coloré en masse, il ne perd pas de couleur s'il est rayé.  
Grande disponibilité de couleur.  
Facilité d'usage: peut être coupé avec un cutter ou des ciseaux.  
Bonne résistance mécanique et aux UV.  
Durée dans le temps.  
Prix compétitif.  
Recyclable en plastique.



**PVC satinado:**

Los perfiles de protección de Arcansas son una línea de perfiles diseñados para unir y proteger las esquinas externas del revestimiento en cerámico. Disponible en diferentes secciones, alturas y colores.

Obtenidos por extrusión de plástico, los perfiles de PVC Arcansas tienen son coloreados en la masa. No cambian de color si se rayan. Representan la solución ideal para aficionados al bricolaje gracias a su versatilidad y facilidad de uso. Disponible en múltiples variedades de color.

**Ventajas:**

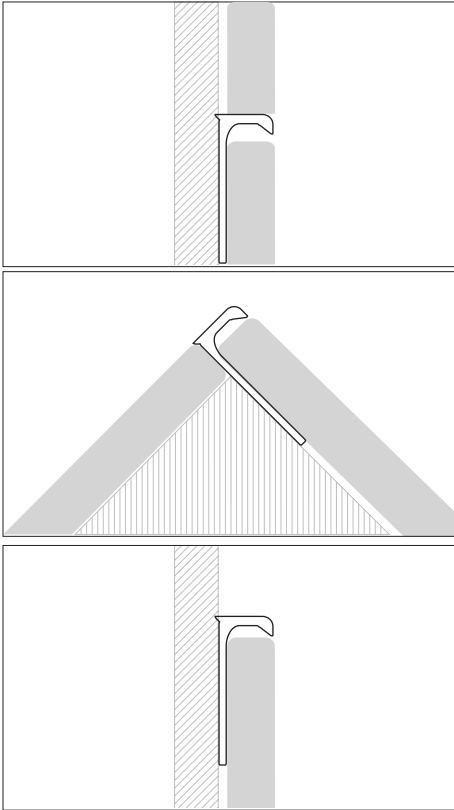
Coloreado en masa, no pierde color si se raya.  
Gran disponibilidad de colores.  
Facilidad de uso: se puede cortar con un cortador o tijeras.  
Buena resistencia mecánica y a los rayos UV.  
Duración en el tiempo.  
Precio competitivo.  
Reciclabile en el plástico.

PIVUCER-ECO	Finitura - Finish	Caratteristiche	EAN	Cod.	H. (mm)	L. (m)	Conf. - Carton	Min. ord.
	bianco satinato satin white		8013237136598	390M / L / 01	6	2,50	100	10
			8013237136604	391M / L / 01	8		100	10
			8013237136611	392M / L / 01	10		100	10
			8013237136628	393M / L / 01	12,5		100	10

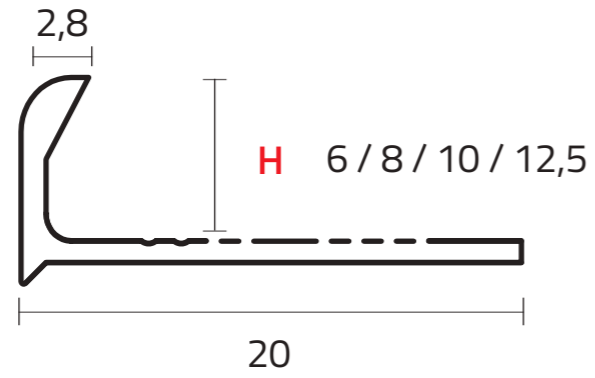

Listello decorativo/ Decorative listello



Protezione spigolo/ Corner protection



Chiusura perimetrale a muro/ Wall covering edging



OPENROUND	Finitura - Finish		Caratteristiche	EAN	Cod.	H. (mm)	L. (m)	Conf. - Carton	Min. ord.
		bianco satinato satin white		8013237136345	253A / A / 01	6	2,50	100	10
		8013237136352		253B / A / 01	8	100		10	
		8013237136369		253C / A / 01	10	100		10	
		8013237136376		255A / A / 01	12,5	100		10	
		grigio chiaro satinato satin pale grey		8013237135850	253A / A / 03	6	2,50	20	10
		8013237135874		253B / A / 03	8	20		10	
		8013237135935		253C / A / 03	10	20		10	
		beige bahama satinato satin bahama beige		8013237137946	253A / A / 17	6	2,50	20	10
		8013237135867		253B / A / 17	8	20		10	
		8013237135928		253C / A / 17	10	20		10	
		8013237135973		255A / A / 17	12,5	20		10	
		jasmine satinato satin jasmine		8013237135881	253B / A / 16	8	2,50	20	10
8013237135942		253C / A / 16		10	20	10			

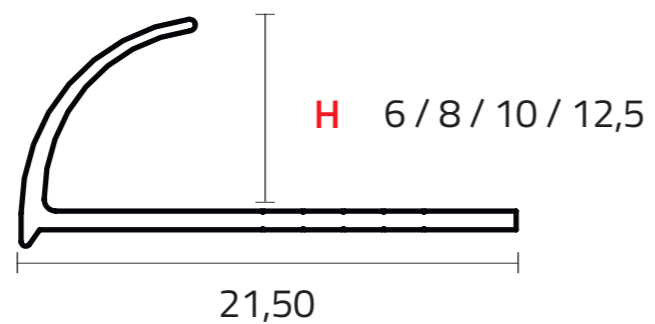

Chiusura perimetrale a muro/ Wall covering edging



Protezione spigolo/ Corner protection

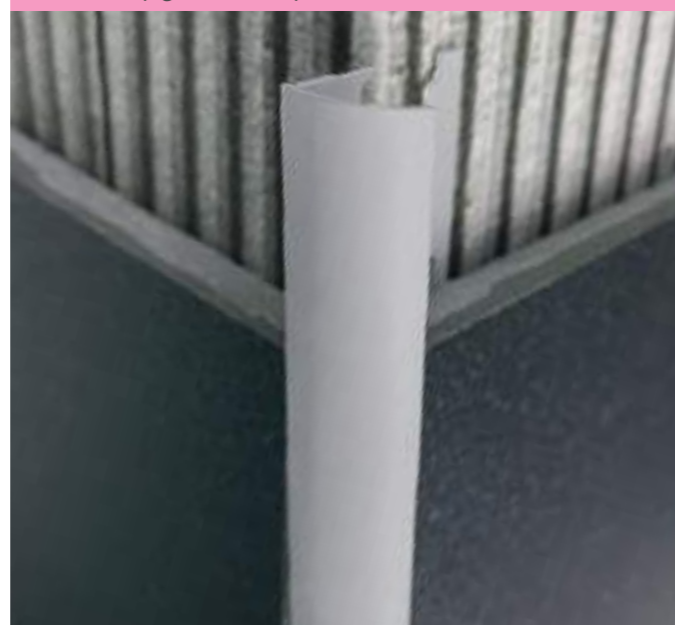

Chiusura perimetrale a muro/ Wall covering edging



Protezione spigolo/ Corner protection



OPENROUND	Finitura - Finish	Caratteristiche	EAN	Cod.	H. (mm)	L. (m)	Conf. - Carton	Min. ord.		
	 <b>New</b> beige satinato satin beige		8013237142308	<b>253B / A / 37</b>	8	2,50	20	10		
	 <b>New</b> beige light satinato satin beige light		8013237140366	<b>253B / A / 02</b>	8	2,50	20	10		
			8013237140373	<b>253C / A / 02</b>	10					
	 <b>New</b> caramello satinato satin caramel		8013237140786	<b>253B / A / 38</b>	8	2,50	20	10		
	 <b>New</b> marrone satinato satin brown		8013237140380	<b>253B / A / 22</b>	8	2,50	20	10		
	 rosa chiaro satinato satin pale pink		8013237135904	<b>253B / A / 05</b>	8	2,50	20	10		
	 celeste satinato satin pale blue		8013237135898	<b>253B / A / 09</b>	8	2,50	20	10		
	 verde chiaro satinato satin pale green		8013237135911	<b>253B / A / 19</b>	8	2,50	20	10		
	 bianco marmorizzato marbled white		8013237138738	<b>255C / A / 23</b>	10	2,50	20	10		

Chiusura perimetrale a muro/ Wall covering edging



Protezione spigolo/ Corner protection



Chiusura perimetrale a muro/ Wall covering edging



Protezione spigolo/ Corner protection



ECOROND	Finitura - Finish		Caratteristiche		EAN	Cod.	H. (mm)	L. (m)	Conf. - Carton	Min. ord.	
		bianco satinato satin white			8013237018160	253A / 01	FR 6		2,50	100	10
					8013237532017	253B / 01	FR 8			100	10
					8013237018177	253C / 01	FR 10			100	10
					8013237042219	255A / 01	FR 12,5			100	10
					8013237066550	253A7 / 01	6			100	10
					8013237066567	253B7 / 01	8			100	10
					8013237066574	253C7 / 01	10			100	10
		grigio chiaro satinato satin pale grey		8013237028633	253A / 03	6		2,50	20	10	
				8013237025595	253B / 03	FR 8			20	10	
				8013237018184	253C / 03	FR 10			20	10	
				8013237042226	255A / 03	12,5			20	10	
				8013237066598	253A7 / 03	6			20	10	
				8013237066604	253B7 / 03	8			20	10	
				8013237066581	253C7 / 03	10			20	10	
	grigio scuro satinato satin dark grey	 	8013237025601	253B / 04	FR 8		2,50	20	10		
			8013237018191	253C / 04	FR 10			20	10		
	rosa chiaro satinato satin pale pink	 									

Chiusura perimetrale a muro/ Wall covering edging



Protezione spigolo/ Corner protection



Chiusura perimetrale a muro/ Wall covering edging



Protezione spigolo/ Corner protection



\* Profili compatibili con capsule a pagina 128  
Profiles compatible with caps on page 128

**ECOROND**

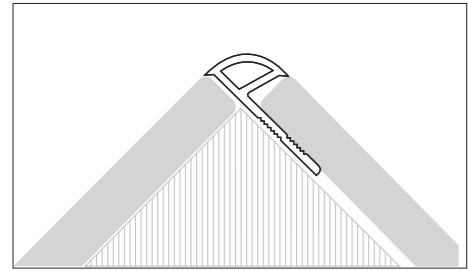
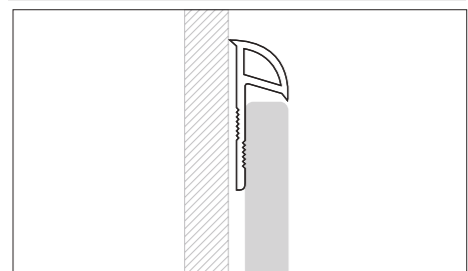

Finitura - Finish			EAN	Cod.	H. (mm)	L. (m)	Conf. - Carton	Min. ord.				
	avorio satinato satin ivory		8013237025298	253B / 07	FR 8	2,50	20	10				
			8013237018214	253C / 07	FR 10		20	10				
								1,00				
	celeste satinato satin pale blue		8013237025281	253B / 09	8	2,50	20	10				
			8013237018238	253C / 09	10		20	10				
	beige bahama satinato satin bahama beige		8013237050689	253B / 17	8	2,50	20	10				
			8013237050696	253C / 17	10		20	10				

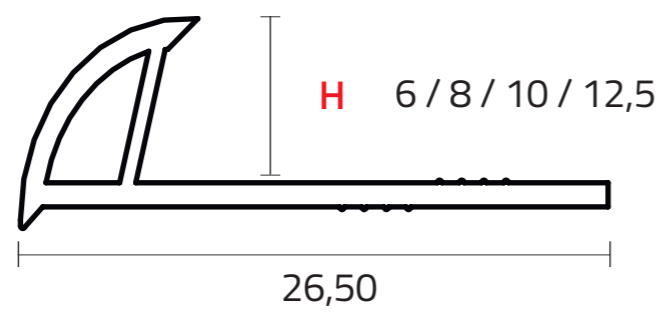

Chiusura perimetrale a muro/ Wall covering edging



Protezione spigolo/ Corner protection







CAPSULE/ CAPS							
Finitura - Finish		EAN	Cod.	H. (mm)	Pz	Min. ord..	
	bianco satinato	8013237060879	253B1 <span>FR</span>	6	1	10	
	satin white	8013237060886	253B2 <span>FR</span>	8	1	10	
		8013237060893	253B3 <span>FR</span>	10	1	10	

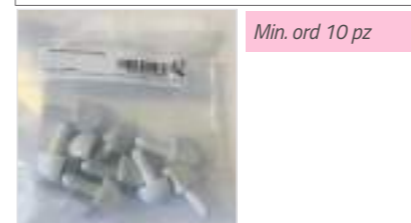

Finitura - Finish		EAN	Cod.	H. (mm)	Pz	Min. ord..	
	bianco satinato			6	4	5	
	satin white	8013237083649	253B2/BLISTER	8	4	5	
		8013237083656	253B3/BLISTER	10	4	5	
		8013237138837	253B4/BLISTER	12,5	4	5	



\* Capsula 01 bianco  
\* White cap 01

ECORONDMARM	Finitura - Finish	Caratteristiche	EAN	Cod.	H. (mm)	L. (m)	Conf. Carton	Min. ord.
	travertino ocra marmorizzato satinato satin marbled ochre travertine		8013237042080	255B / 100	8	2,50	10	10
			8013237045937	255C / 100	10			
	travertino grigio marmorizzato satinato satin marbled grey travertine		8013237042097	255B / 101	8	2,50	10	10
			8013237046323	255C / 101	10			
	travertino beige marmorizzato satinato satin marbled beige travertine		8013237046064	255B / 111	8	2,50	10	10
			8013237046255	255C / 111	10			

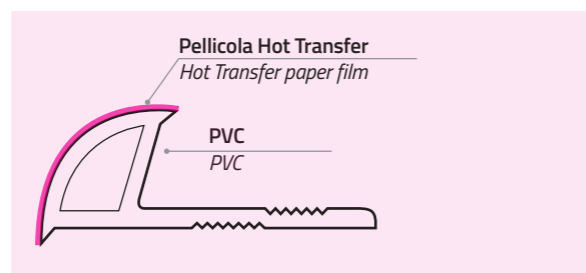

Conf. da 10 pz

Chiusura perimetrale a muro/ Wall covering Edging



Protezione spigolo/ Corner protection



RONDEVI	Finitura - Finish		Caratteristiche	EAN	Cod.	H. (mm)	L. (m)	Conf. - Carton	Min. ord.	€/m	€/pz
		bianco satinato satin white					2,50				
		grigio chiaro satinato satin pale grey									
		grigio scuro satinato satin dark grey					2,50				
		rosa chiaro satinato satin pale pink									
		avorio satinato satin ivory					2,50				
		celeste satinato satin pale blue									
		beige bahama satinato satin bahama beige					2,50				
		verde acqua satinato satin water green									

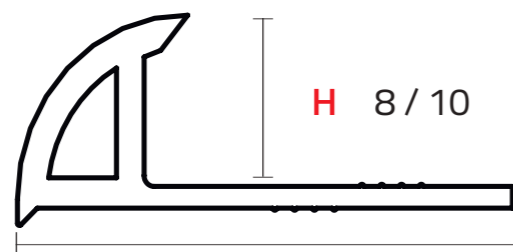



Chiusura perimetrale a muro/ Wall covering edging

Protezione spigolo/ Corner protection

Chiusura perimetrale a muro/ Wall covering edging

Protezione spigolo/ Corner protection

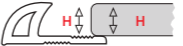

RONDEVIMARM	Finitura - Finish	Caratteristiche	EAN	Cod.	H. (mm)	L. (m)	Conf. Carton	Min. ord.	€/m	€/pz
		travertino ocra marmorizzato satinato satin marbled ochre travertine				2,50				
		travertino grigio marmorizzato satinato satin marbled grey travertine				2,50				
		travertino beige marmorizzato satinato satin marbled beige travertine				2,50				

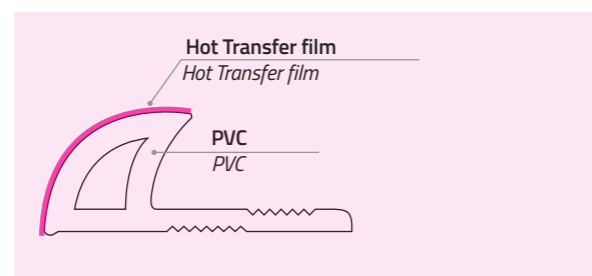

Chiusura perimetrale a muro/ Wall covering edging



Protezione spigolo/ Corner protection





# PVC Extra Lucido

Extra Shiny PVC/ PVC Extra Brillant/ PVC Extra Brillante

## PVC Extra lucido:

Ottenuti mediante una speciale tecnica di estrusione plastica, i profili di protezione Arcansas sono una linea di profili progettati per raccordare e proteggere gli angoli esterni dei rivestimenti in ceramica. Disponibili in differenti sezioni, altezze e colori.

Speciale lavorazione che conferisce una superficie brillantissima come fosse alluminio verniciato a polveri epossidiche. Colorato in massa, non perde il colore se graffiato.

Rappresentano la soluzione ideale per professionisti e DIYers grazie alla elevata qualità estetica e alla facilità di utilizzo. Disponibile in moltissimi colori oltre agli eleganti bianco, nero.

## Vantaggi:

Grande disponibilità di colori vivaci e decorativi.  
Facilità d'uso: tagliabile con taglierino o forbici.  
Buona resistenza meccanica e ai raggi UV.  
Durata nel tempo.  
Riciclabile nella plastica.

## Extra shiny PVC:

Obtained by a special extruding technique, Arcansas protection profiles are designed to connect and protect the external corners and edges of ceramic tiles coverings. Available in different sections, heights and colours.

Thanks to a special processing, the profile has a very bright surface and looks like aluminum painted with epoxy powders. Mass-coloured, it does not lose the colour if scratched.

These profiles represent the ideal solution for professionals and DIYers thanks to their high aesthetic quality and ease of use. Available in many colours besides the elegant white and black.

## Advantages:

Wide range of vivid and decorative colours.  
Ease of use: can be cut with a cutter or scissors.  
Good mechanical and UV resistance  
Durability.  
Recyclable.

## PVC extra brillant :

Obtenus grâce à une technique d'extrusion plastique spéciale, les profils de protection Arcansas sont une gamme de profils conçus pour connecter et protéger les coins externes des revêtements carrelage. Disponible en différentes sections, hauteurs et couleurs.

Un traitement spécifique permet de donner au profilé une surface très brillante comme s'il s'agissait d'aluminium enduit de poudre époxy. Coloré en masse, il ne la perd pas s'il est rayé.

Ils représentent la solution idéale pour les professionnels et les bricoleurs grâce à leur haute qualité esthétique et leur facilité d'utilisation. Disponible en plusieurs couleurs en plus de l'élégant blanc, noir.

## Avantages:

Grande disponibilité de couleurs vives et décoratives.  
Facilité d'utilisation : peut être coupé avec un cutter ou des ciseaux.  
Bonne résistance mécanique et aux UV.  
Durée dans le temps.  
Recyclable en plastique.

## PVC extra brillante:





Obtenidos a través de una técnica especial de extrusión de plástico, los perfiles de protección Arcansas son una línea de perfiles diseñados para conectar y proteger las esquinas externas de los revestimientos cerámicos. Disponible en diferentes secciones, alturas y colores.

Procesamiento especial que confiere una superficie muy brillante como si fuera aluminio pintado con polvo epoxi.

Coloreado en masa, no pierde color si se raya.  
Representan la solución ideal para profesionales y aficionados al bricolaje gracias a su alta calidad estética y facilidad de uso. Disponible en muchos colores además del elegante blanco y del elegante negro.

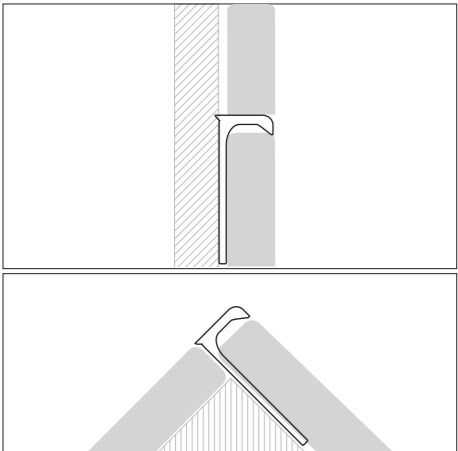
## Vantajas:

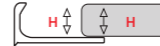
Gran disponibilidad de colores brillantes y decorativos.  
Facilidad de uso: se puede cortar con un cortador o tijeras.  
Buena resistencia mecánica y a los rayos UV.  
Duración en el tiempo.  
Reciclabile en el plástico.

PIVUCER	Finitura - Finish	Caratteristiche	EAN	Cod.	H (mm)	L. (m)	Conf. Carton	Min. ord.	
	bianco lucido bright white		8013237020583	390 / 01	6		2,50	100	10
			8013237391010	391 / 01	8		2,50	100	10
			8013237021061	392 / 01	10		2,50	100	10
			8013237021290	393 / 01	12,5		2,50	100	10
			8013237066543	392B / 01	10		1,00	100	10
	<b>New</b> grigio chiaro lucido bright light grey		8013237020590	390 / 03	6		2,50	20	10
			8013237020682	391 / 03	8		2,50	20	10
			8013237021078	392 / 03	10		2,50	20	10
			8013237142292	393 / 03	12,5		2,50	20	10

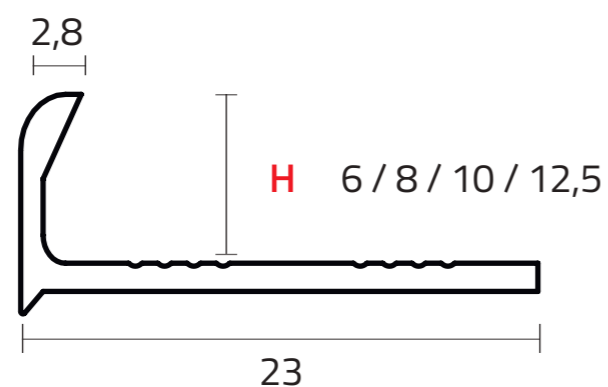

Listello decorativo/ Decorative

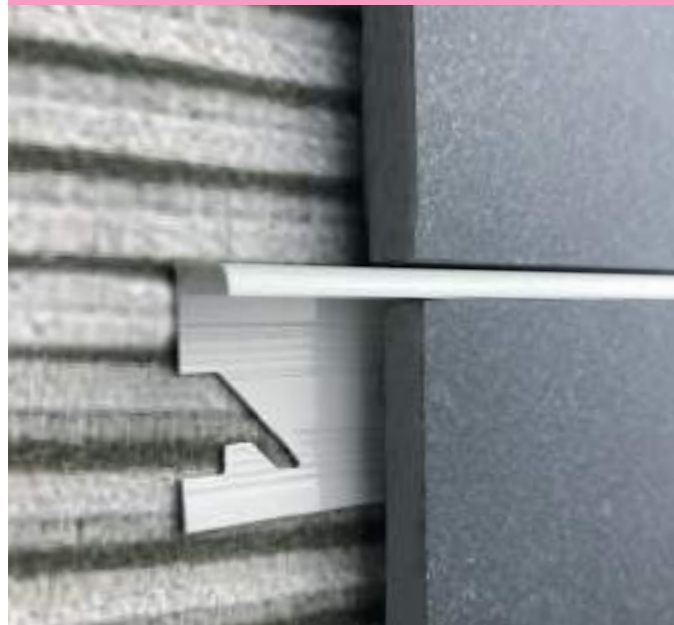

Protezione angoli esterni / Outside Corners Protection



Chiusura perimetrale a muro/ Wall covering edging



Protezione spigolo/ Corner protection



RONDBRIL	Finitura - Finish		Caratteristiche		EAN	Cod.	H. (mm)	L. (m)	Conf. Carton	Min. ord.		
		bianco lucido bright white			8013237016777	250B / 01	6	2,50	100	10		
					8013237511012	251A / 01	FR		8	100	10	
					8013237002527	252A / 01	FR		10	100	10	
		grigio chiaro lucido bright pale grey			8013237017248	251A / 03	8	2,50	20	10		
					8013237017774	252A / 03	FR		10	20	10	
		grigio scuro lucido bright dark grey			8013237017262	251A / 04	8	2,50	20	10		
					8013237017798	252A / 04	10		20	10		
		rosa chiaro lucido bright pale pink						2,50				
		avorio lucido bright ivory						2,50				
		pesca lucido bright peach						2,50				
	celeste lucido bright pale blue						2,50					

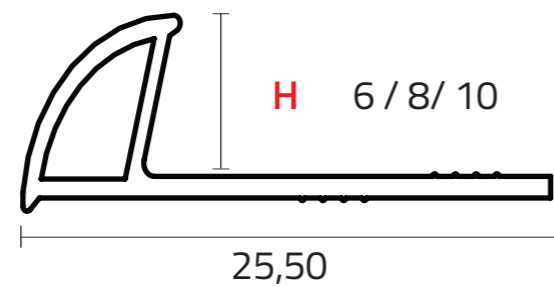

\* Profili compatibili con capsule a pagina 144  
Profiles compatible with caps on page 144

RONDBRIL	Finitura - Finish	Caratteristiche	EAN	Cod.	H. (mm)	L. (m)	Conf. Carton	Min. ord.		
		beige lucido bright beige	8013237017361	251A / 10	8	2,50	20	10		
		verde pistacchio lucido bright pistachio green				2,50				
		rosso vivace lucido bright red				2,50				
		jasmine lucido bright jasmine	8013237085360	251A / 16	8	2,50	20	10		

Chiusura perimetrale a muro/ Wall covering edging



Protezione spigolo/ Corner protection

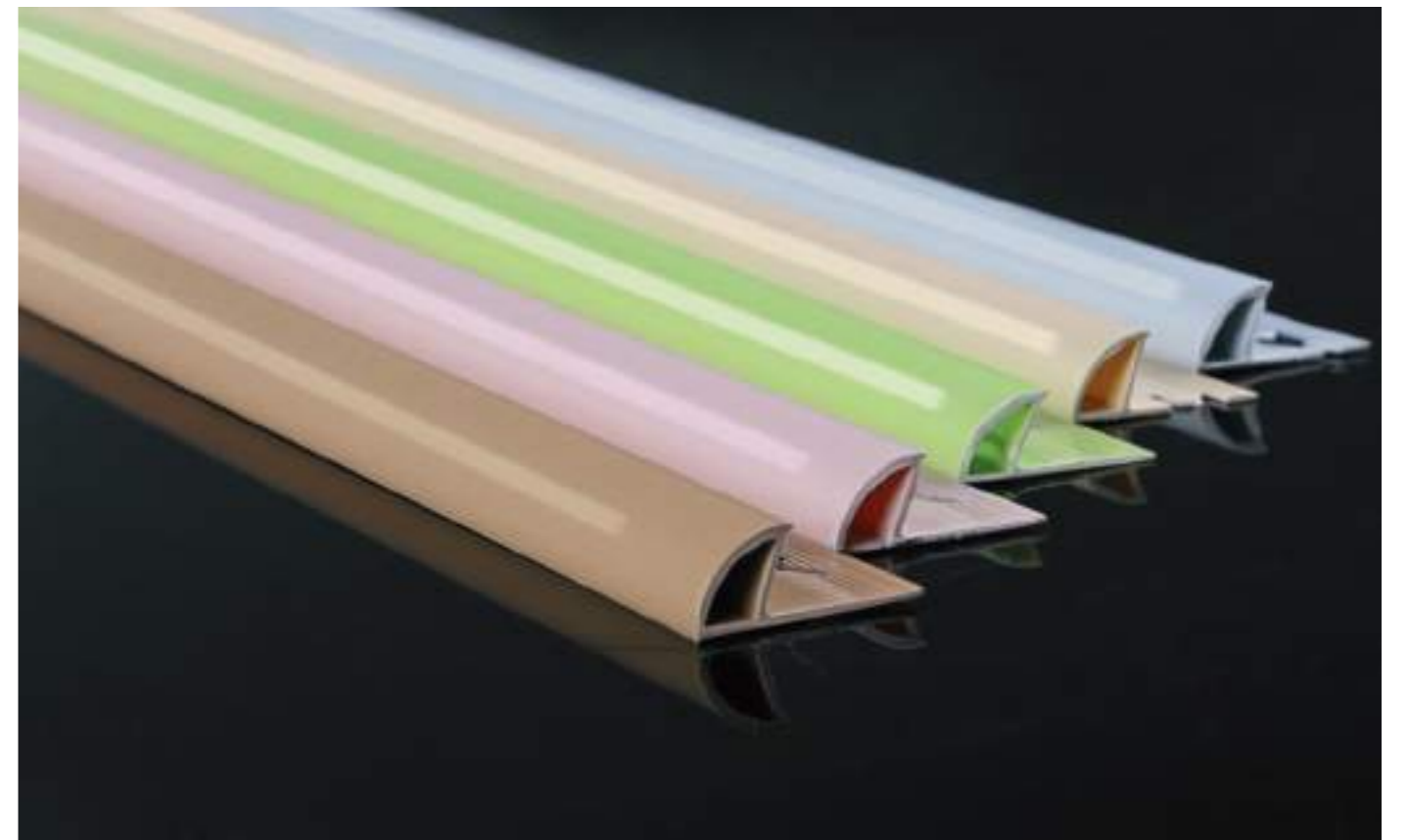





**CAPSULE/ CAPS**

Finitura - Finish		EAN	Cod.	H. (mm)	Pz.	Min. ord.	
	bianco lucido	8013237070809	<b>251AH8</b>	8	1	10	
	bright white	8013237070816	<b>252AH10</b>	10	1	10	



Min. ord 10 pz

**BLISTER**

Finitura - Finish		EAN	Cod.	H. (mm)	Pz.	Min. ord.	
	bianco lucido						
	bright white	8013237083625	<b>251AH8/BLISTER</b>	8	4	5	
		8013237083632	<b>252AH10/BLISTER</b>	10	4	5	



\* Capsula 01 bianco  
\* White cap 01

**RONDBRIL APERTO**

**New**

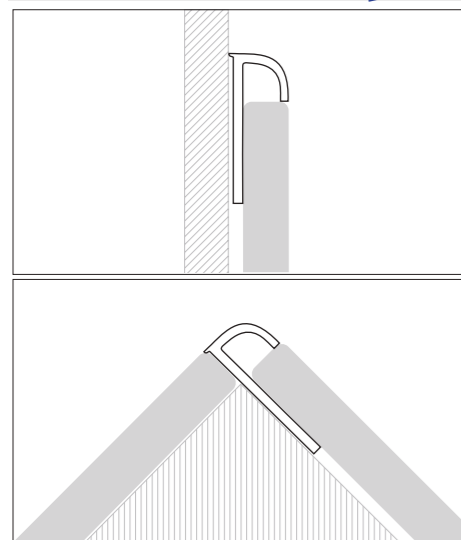

Finitura - Finish	Caratteristiche	EAN	Cod.	H. (mm)	L. (m)	Conf. Carton	Min. ord.
bianco lucido bright white		8013237139780	252A/A/ 01	 10	2,50	100	10



Chiusura perimetrale a muro/ Wall covering edging



Protezione spigolo/ Corner protection



ECORONDMARM	Finitura - Finish	Caratteristiche	EAN	Cod.	H. (mm)	L. (m)	Conf. Carton	Min. ord.
		B	8013237045968	255B / 23	8	2,50	10	10
			8013237046132	255C / 23	10			
		B				2,50	10	10
		B	8013237046293	255C / 26	10	2,50	10	10
		B	8013237046101	255B / 27	8	2,50	10	10
			8013237046309	255C / 27	10			
		B				2,50	10	10
		B	8013237045982	255B / 102	8	2,50	10	10
			8013237046170	255C / 102	10			
		B				2,50	10	10
		B				2,50	10	10
		B	8013237046019	255B / 105	8	2,50	10	10
			8013237046217	255C / 105	10			
		B	8013237046224	255C / 106	10	2,50	10	10
		B	8013237046033	255B / 107	8	2,50	10	10
			8013237046231	255C / 107	10			
		B				2,50	10	10
		B	8013237046057	255B / 109	8	2,50	10	10
			8013237046163	255C / 109	10			
		B	8013237046071	255B / 112	8	2,50	10	10
			8013237046262	255C / 112	10			
		B				2,50	10	10
		B	8013237046095	255B / 114	8	2,50	10	10
			8013237046286	255C / 114	10			

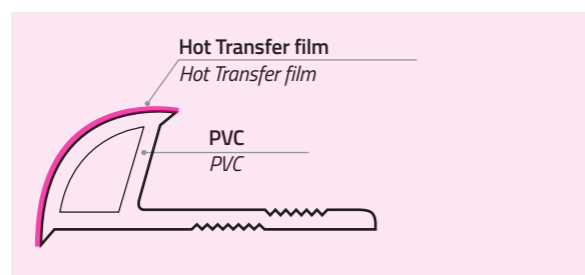

RONDEVIMARM	Finitura - Finish	Caratteristiche	EAN	Cod.	H. (mm)	L. (m)	Conf. Carton	Min. ord.	€/m	€/pz	
	bianco carrara marmorizzato lucido polished marbled carrara white										
	turchese marmorizzato lucido polished marbled turquoise										
	beige marmorizzato lucido polished marbled beige										
	verde chiaro marmorizzato lucido polished marbled pale green										
	rosa portogallo marmorizzato lucido polished marbled portuguese pink										
	azzurro marmorizzato lucido polished marbled bright blue										
	verde guatemala marmorizzato lucido polished marbled guatemala green										
	celeste marmorizzato lucido polished marbled pale blue										
	giallo marmorizzato lucido polished marbled yellow										
	rosa chiaro marmorizzato lucido polished marbled pale pink										
	verde acqua marmorizzato lucido polished marbled water green										
	beige chiaro marmorizzato lucido polished marbled pale beige										
	visone marmorizzato lucido polished marbled mink										
	verde oltremare marmorizzato lucido polished marbled sea green										
travertino nocciola marmorizzato polished marbled brown travertine											

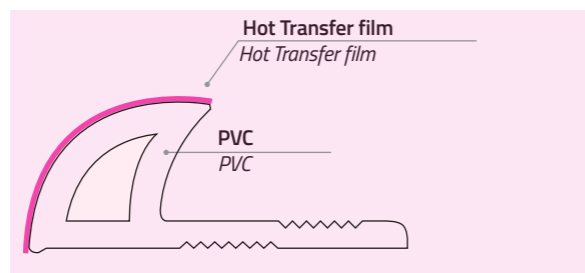

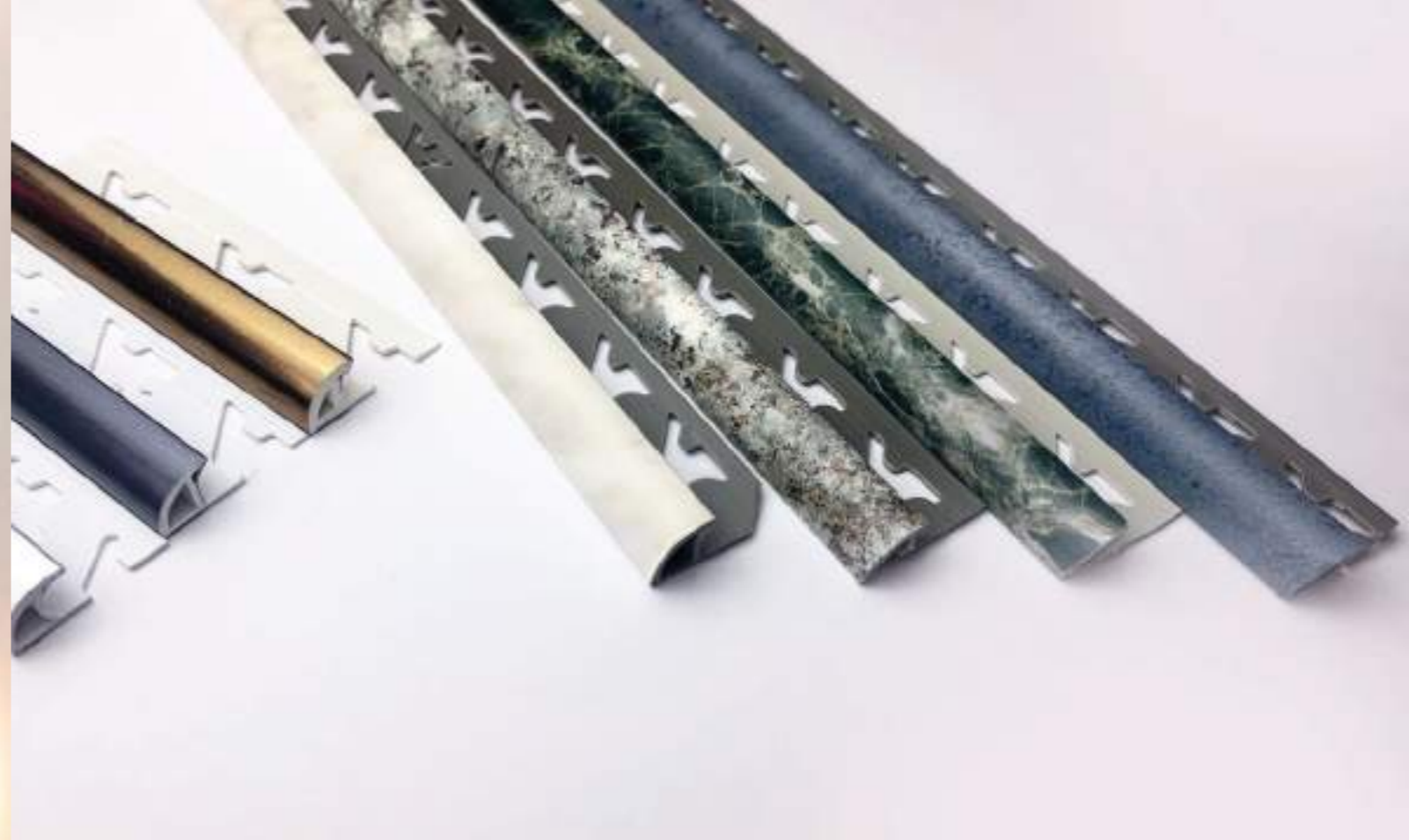

# PVC Rivestito

Coated PVC/ PVC enduit/ PVC recubierto

## PVC Rivestito:

Realizzato per estrusione plastica. Viene successivamente ricoperto mediante pellicole antigraffio che derivano direttamente dalle tecnologie di rivestimento utilizzate nell'industria dell'arredamento. Sono caratterizzate pertanto da elevato effetto cromatico decorativo e altissima resistenza all'acqua, umidità.  
Non pulire con materiale abrasivo.

## Vantaggi:

Antigraffio.  
Resistente all'acqua.  
Grande disponibilità di colori vivaci e decorativi.  
Facilità d'uso: tagliabile con taglierino o forbici.  
Inattaccabile dai raggi UV.  
Durata nel tempo.  
Riciclabile nella plastica.

## Coated PVC:

Obtained by plastic extrusion, it is subsequently covered with scratch-resistant films which are the same as those used in the furniture industry and are therefore characterized by a high decorative colour effect and very high resistance to water and humidity.  
Do not clean with abrasive material.

## Advantages:

Scratch-resistant.  
Water resistant.  
Wide range of vivid and decorative colours.  
Ease of use: can be cut with a cutter or scissors.  
Resistant to UV rays.  
Durability.  
Recyclable.

## PVC enduit :

Fabriqué par extrusion de plastique. Il est ensuite recouvert d'un film anti-rayures issu directement des technologies de revêtement utilisées dans l'industrie du meuble. Ils se caractérisent donc par un bel effet de couleur très décoratif et une très haute résistance à l'eau et à l'humidité.  
A ne pas nettoyer avec un matériau abrasif.

## Avantages :

Résistant aux rayures.  
Résistant à l'eau.  
Grande disponibilité de couleurs vives et décoratives.  
Facilité d'utilisation : peut être coupé avec un cutter ou des ciseaux.  
Résistant aux rayons UV.  
Durée dans le temps.  
Recyclable en plastique.

## PVC recubierto:

Hecho por extrusión de plástico. Posteriormente se cubre con películas resistentes a los arañazos con las tecnologías de revestimiento utilizadas en la industria del mueble. Por lo tanto, se caracterizan por un alto efecto de color decorativo y una resistencia muy alta al agua, a la humedad.  
No limpiar con material abrasivo.

## Ventajas:

Resistente a los arañazos.  
Resistente al agua.  
Gran disponibilidad de colores brillantes y decorativos.  
Facilidad de uso: se puede cortar con un cortador o tijeras.  
Resistente a los rayos UV.  
Duración en el tiempo.  
Reciclabile en plástico.

RONDIMET	Finitura - Finish	Caratteristiche	EAN	Cod.	H. (mm)	L. (m)	Conf. - Carton	Min. ord.
	 oro metallico spazzolato brushed metallic gold							
	 champagne metallico spazzolato brushed metallic champagne							
	 bronzo metallico spazzolato brushed metallic bronze		8013237071868	<b>295/19</b>		2,50	20	10
	 grigio fumo metallico spazzolato brushed metallic smoky grey		8013237100032	<b>295/21</b>		2,50	20	10
	 alluminio metallico spazzolato brushed metallic aluminum		8013237072100	<b>295/90S</b>		2,50	20	10
			8013237072070	<b>296/90S</b>		2,50	20	10

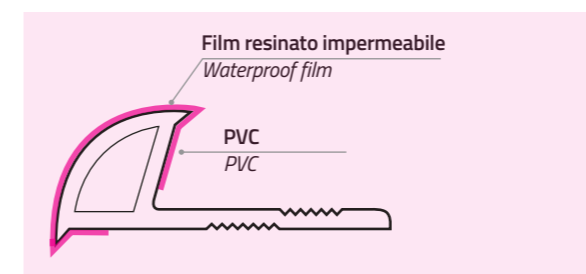
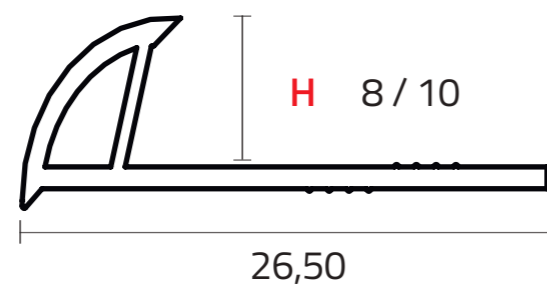

Chiusura perimetrale a muro/ Wall covering edging



Protezione spigolo/ Corner protection



Chiusura perimetrale a muro/ Wall covering edging



Protezione spigolo/ Corner protection



RONDELUX	Finitura - Finish	Caratteristiche	EAN	Cod.	H. (mm)	L. (m)	Conf. - Carton	Min. ord.
	verde scuro marmorizzato satinato satin marbled dark green	B						
	beige marmorizzato satinato satin marbled beige	B						
	verde chiaro marmorizzato satinato satin marbled pale green	B						
	blu marmorizzato satinato satin marbled blue	B						
	grigio marmorizzato satinato satin marbled grey							
	bianco marmorizzato satinato satin marbled white	B						

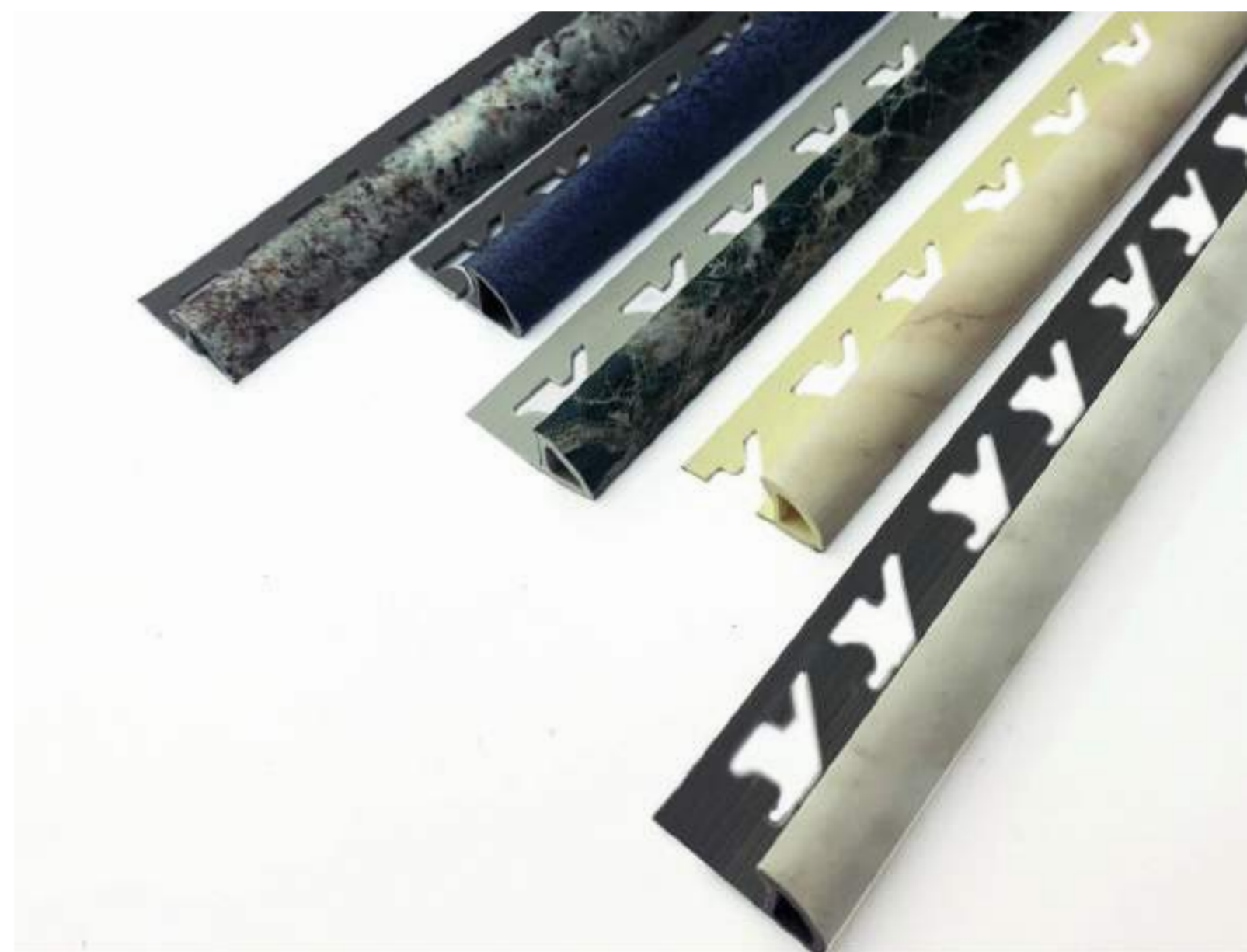
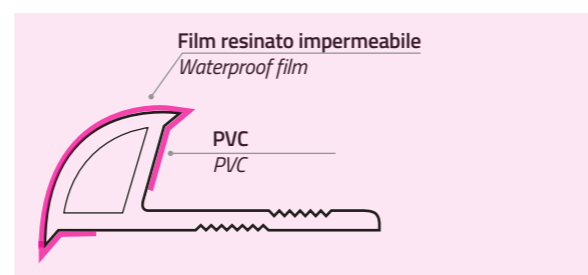
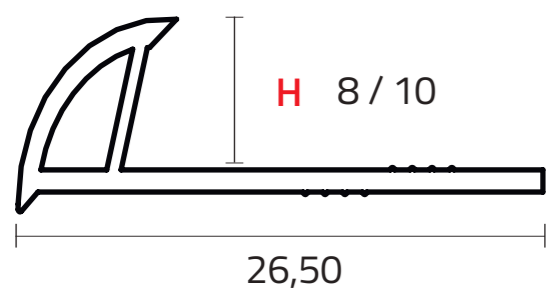

Chiusura perimetrale a muro/ Wall covering edging



Chiusura perimetrale a muro/ Wall covering edging





# Paraspigoli

## Corner Profiles/ Protecteur D'angle/ Guardacantos

### Paraspigoli:

I Paraspigoli Arcansas sono progettati e prodotti per proteggere gli spigoli verticali ed orizzontali dopo la posa del rivestimento. La rapidità e semplicità di posa è garantita dallo speciale adesivo presente in alcune versioni.

### Paraspigoli in Acciaio Inox:

Ottenuti per profilatura nella lega più nobile disponibile oggi sul mercato, AISI 304 V2A, grazie alla sua elevatissima inossidabilità e resistenza agli agenti meccanici e atmosferici, è adatto per interni ed esterni. Ha un aspetto elegante e solido. Adatto in edilizia, altamente protettivo e decorativo.

### Paraspigoli in Alluminio:

L'alluminio subisce un trattamento di ossidazione anodica per immersione in vasche elettrolitiche e successivamente nelle vasche del colore che viene poi fissato nelle ultime vasche del lungo processo anodico, dando vita ad uno strato protettivo che protegge il profilo.

### Paraspigoli in alluminio effetto pietra:

Ottenuti per estrusione e successiva verniciatura a polveri epossidiche elettrostatiche, sono precedentemente trattati con uno speciale procedimento di sgrassaggio e pre-verniciatura per conferire resistenza e massima adesione alla successiva verniciatura.

### Paraspigoli in PVC:

Ottenuti per estrusione plastica, i profili in PVC Arcansas sono colorati in massa. Non cambiano colore se graffiati.

### Corner Profiles:

Arcansas Corners Profiles are designed and produced to protect vertical and horizontal corners with out without ceramic tiles coating. The special adhesive tape guarantees a quick and easy installation.

### Stainless-steel corner profiles:

Obtained by profiling in alloy AISI 304 V2A, the most noble alloy available on the market today, thanks to its high resistance to the rust and to mechanical and atmospheric agents, it is suitable both for indoors and outdoors. It has an elegant and solid appearance. Suitable for construction, highly protective and decorative.

### Aluminium corner profiles:

The aluminium is anodized by immersion in electrolytic tanks and subsequently in the colour tanks, creates a protective layer that protects the colour itself.

### Stone look aluminium corner profiles:

Obtained by extrusion and subsequent painting with electrostatic epoxy powders, they are previously treated with a special degreasing and pre painting process to give resistance and maximum adhesion to the subsequent painting.

### PVC corner profiles:

Arcansas PVC profiles are mass-colored. They do not change colour if scratched.

### Protecteur D'angle:

Les protecteur d'angle Arcansas sont conçus et fabriqués pour protéger les bords verticaux ou horizontaux après la pose du revêtement. La rapidité et la simplicité d'installation sont garanties par l'adhésif spécial présent dans certaines versions.

### Protecteur d'angle en acier inoxydable :

Obtenu par profilage dans l'alliage le plus noble disponible aujourd'hui sur le marché : l'AISI 304 V2A, grâce à sa très haute résistance à la rouille et sa résistance aux agents mécaniques et atmosphériques, convient pour l'intérieur et l'extérieur. Il a une apparence élégante et solide. Convient pour la construction. Hautement protecteur et décoratif.

### Protecteur d'angle en aluminium :

L'aluminium subit un traitement d'oxydation anodique par immersion dans des réservoirs électrolytiques puis dans les réservoirs de couleur qui est ensuite fixée dans les derniers réservoirs du long processus anodique, créant une couche protectrice qui protège le profilé.

### Protecteur d'angle en aluminium effet pierre :

Obtenus par extrusion et ensuite peint avec des poudres époxy électrostatiques, ils sont préalablement traités par un procédé spécial de dégraissage et de pré-peinture pour donner une résistance et une adhérence maximale à la peinture suivante.

### Protecteur d'angle en PVC :

Obtenus par extrusion de plastique, les profilés PVC Arcansas sont colorés en masse. Ils ne perdent pas leur couleur s'ils sont rayés.

### Guardacantos:

Los guardacantos Arcansas están diseñados y producidos para proteger los bordes verticales u horizontales después de la colocación de revestimientos. La rapidez y la simplicidad de la instalación están garantizadas por el adhesivo especial presente en algunas versiones.

### Guardacantos en acero inoxidable:

Obtenido al perfilar la aleación más noble disponible en el mercado hoy en día, AISI 304 V2A, gracias a su muy alta resistencia a la oxidación y resistencia a los agentes mecánicos y atmosféricos, es indicado sea para interiores y exteriores. Tiene un aspecto elegante y sólido. Idóneo en construcción, altamente protector y decorativo.

### Guardacantos de aluminio:

El aluminio se somete a un tratamiento de oxidación anódica por inmersión en tanques electrolíticos y posteriormente en tanques de color que luego se fijan en los últimos tanques del largo proceso anódico, creando una capa protectora que protege el perfil.



### Guardacantos de aluminio con efecto piedra:



Obtenidos por extrusión y pintura posterior con polvos epoxídicos electrostáticos, se tratan previamente con un proceso especial de desengrasado y pre-pintura para dar resistencia y máxima adhesión a la pintura sucesiva.

### Guardacantos de PVC:

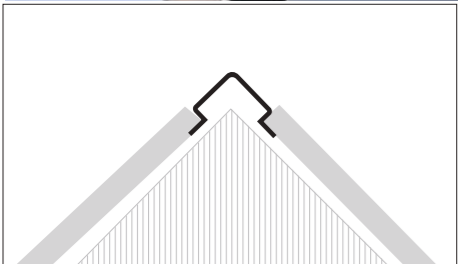

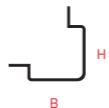
Obtenidos por extrusión de plástico, los perfiles de PVC Arcansas son coloreados en masa. No cambian de color si se rayan.

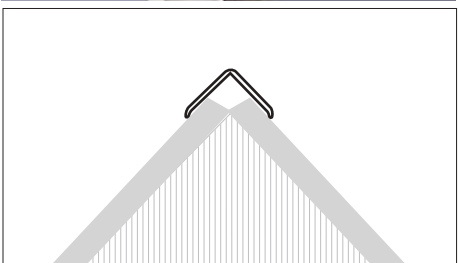
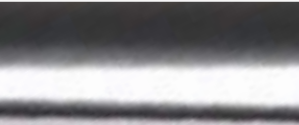
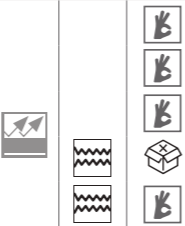
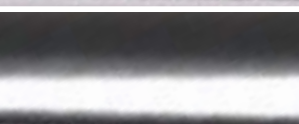
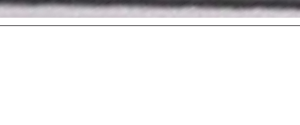

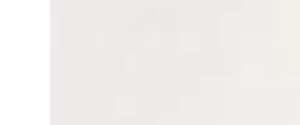

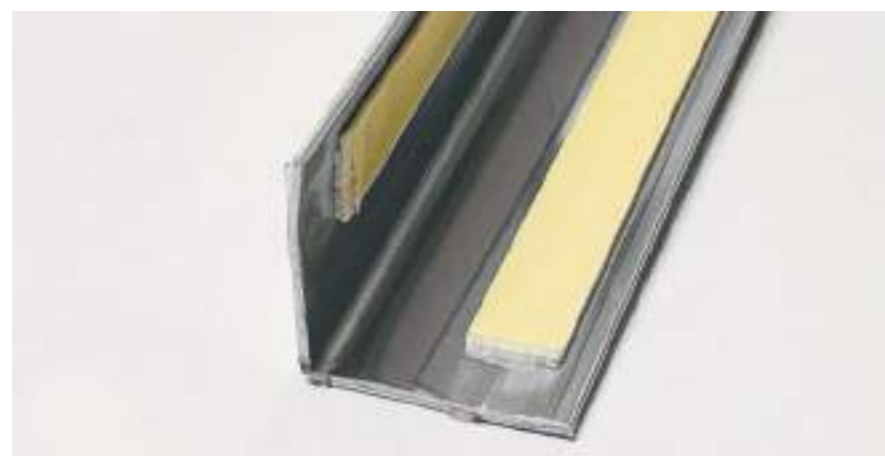

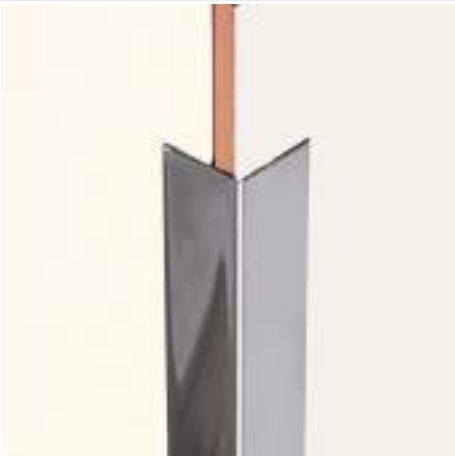
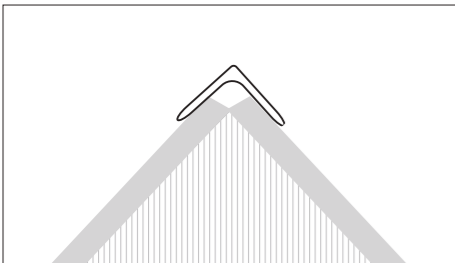
ANGOCER	Finitura - Finish	Caratteristiche	EAN	Cod.	B x H. (mm)	L. (m)	Conf. - Carton	Min. ord.
 	 acciaio inox lucido AISi 304 polished stainless steel AISI 304							

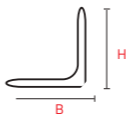
SPIGINOX	Finitura - Finish	Caratteristiche	EAN	Cod.	B x H. (mm)	L. (m)	Conf. - Carton	Min. ord.
 	 acciaio inox lucido AISi 304 polished stainless steel AISI 304		8013237007218	<b>072A</b>	25 x 25	3,00	10	5
	 acciaio inox lucido AISi 304 polished stainless steel AISI 304		8013237007133	<b>071C</b>	30 x 30		10	5
	 acciaio inox lucido AISi 304 polished stainless steel AISI 304		8013237012274	<b>071H</b>	50 x 50		10	5
	 acciaio inox lucido AISi 304 polished stainless steel AISI 304		8013237012298	<b>072</b>	25 x 25	3,00	10	5
	 acciaio inox lucido AISi 304 polished stainless steel AISI 304							

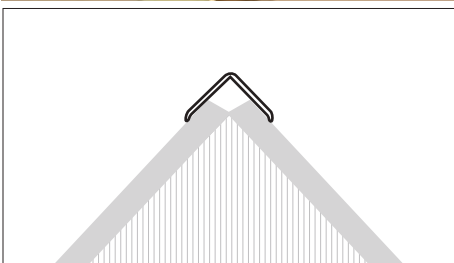
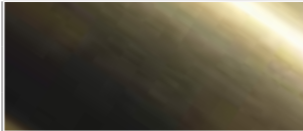



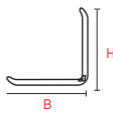
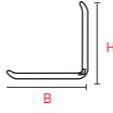

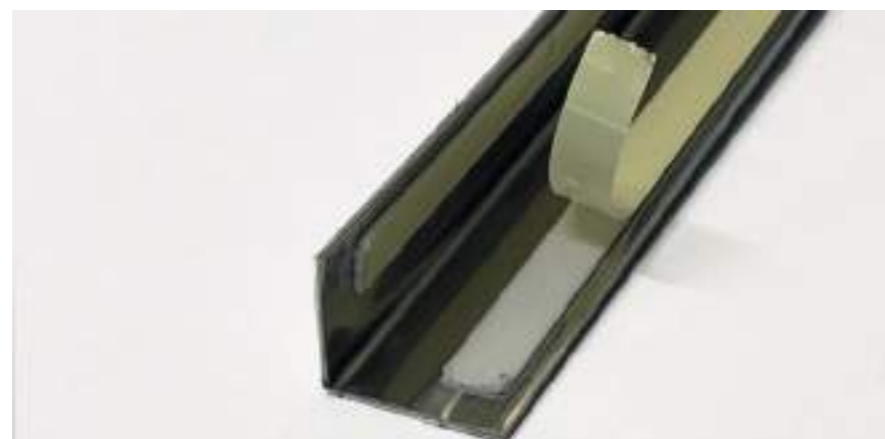

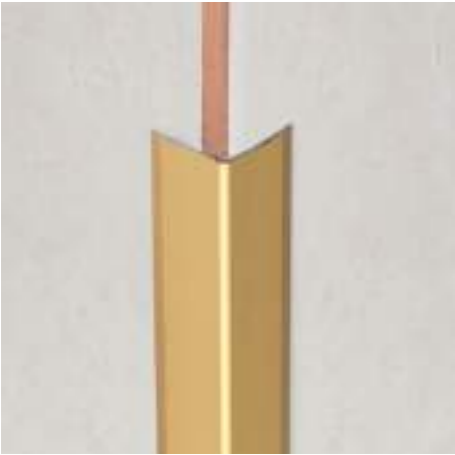
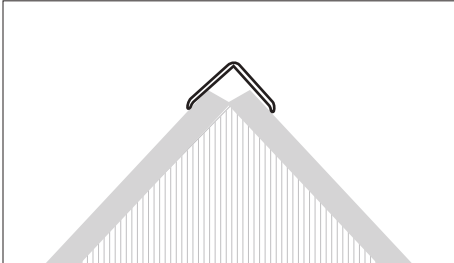
ANGO-INOX	Finitura - Finish	Caratteristiche	EAN	Cod.	BxH. (mm)	L. (m)	Conf. Carton	Min. ord.		
 	 acciaio inox lucido AISI 304 polished stainless steel AISI 304		8013237083588	1506B	FR 15 x 15	 2,60	10	5		
			8013237083595	1507B	FR 20 x 20		10	5		
			8013237083601	1508B	FR 25 x 25		10	5		
			8013237083618	1509B	FR 30 x 30		10	5		



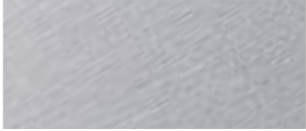



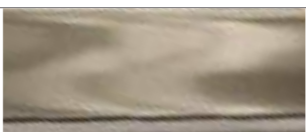
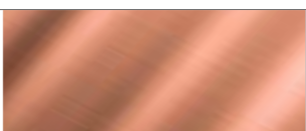
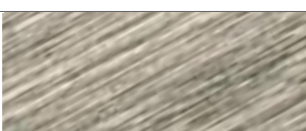
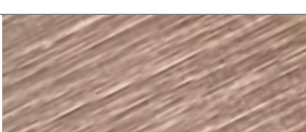











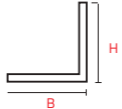





SPIGBRAS	Finitura - Finish	Caratteristiche	EAN	Cod.	B x H. (mm)	L. (m)	Conf. - Carton	Min. ord.		
 	 ottone lucido polished brass	   			 					

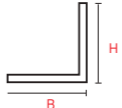







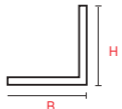
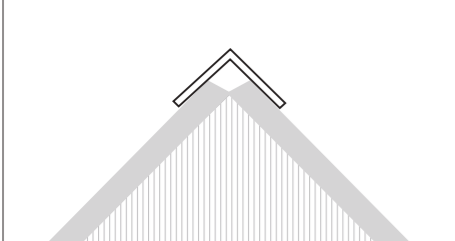

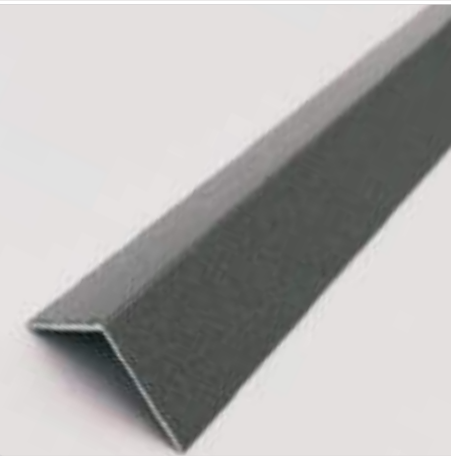







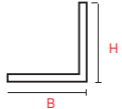





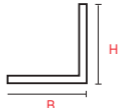

SPIGAL	Finitura - Finish		Caratteristiche		EAN	Cod.	BxH. (mm)	L. (m)	Conf. Carton	Min. ord		
 		argento anodizzato satinato	B		8013237005269	046B4 / 90	25 x 25	3,00	50	10		
		satén anodised silver										
		argento anodizzato satinato	B		8013237005214	046B1 / 90	25 x 25	3,00	50	10		
		satén anodised silver										
	oro anodizzato satinato	B		8013237005276	046B4 / 91	25 x 25	3,00	50	10			
	satén anodised gold											
		oro anodizzato satinato	B		8013237005221	046B1 / 91	25 x 25	3,00	50	10		
		satén anodised gold										



ANGO-ALU	Finitura - Finish		Caratteristiche	EAN	Cod.	BxH. (mm)	L. (m)	Conf. Carton	Min. ord.
		alluminio naturale natural aluminium	B	8013237082932	851P	15 x 15	2,60	50	10
				8013237082949	852P	20 x 20		50	10
				8013237082956	853R	25 x 25		50	10
				8013237082963	855R	30 x 30		50	10
		argento satinato satin silver	B	8013237083144	851D	FR 15 x 15	2,60	50	10
				8013237083236	852D	FR 20 x 20		50	10
				8013237083243	853D	FR 25 x 25		50	10
				8013237083250	855D	FR 30 x 30		50	10
		bianco verniciato powder coated white	B	8013237082895	851M1	FR 15 x 15	2,60	50	10
				8013237082901	852N1	FR 20 x 20		50	10
				8013237082918	853P1	FR 25 x 25		50	10
				8013237082925	855Q1	FR 30 x 30		50	10
		argento anodizzato lucido polished anodised silver	B	8013237508500	850 / 93	10 x 10	2,00	50	10
				8013237508517	851 / 93	15 x 15		50	10
				8013237508524	852 / 93	20 x 20		50	10
				8013237508555	855 / 93	30 x 30		50	10
		titanio anodizzato lucido polished anodised titanium	B						
	ramato anodizzato lucido polished anodised copper	B	8013237071004	850 / 99	10 x 10	2,00	50	10	
			8013237071127	851 / 99	15 x 15		50	10	
			8013237071141	852 / 99	20 x 20		50	10	
			8013237071769	853 / 99	25 x 25		50	10	
			8013237071776	855 / 99	30 x 30		50	10	
	titanio anodizzato spazzolato brushed anodised titanium	B	8013237055639	850 / 96	10 x 10	2,00	50	10	
			8013237055677	851 / 96	15 x 15		50	10	
			8013237055714	852 / 96	20 x 20		50	10	
			8013237055752	853 / 96	25 x 25		50	10	
	ramato anodizzato spazzolato brushed anodised copper	B	8013237055646	850 / 99S	10 x 10	2,00	50	10	
			8013237055684	851 / 99S	FR 15 x 15		50	10	
			8013237055721	852 / 99S	20 x 20		50	10	
			8013237055806	855 / 99S	30 x 30		50	10	
	nero anodizzato spazzolato brushed anodised black	B	8013237067137	850 / 63	10 x 10	2,00	50	10	
			8013237067151	851 / 63	15 x 15		50	10	
			8013237067175	852 / 63	20 x 20		50	10	
			8013237067212	855 / 63	30 x 30		50	10	



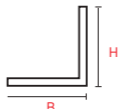
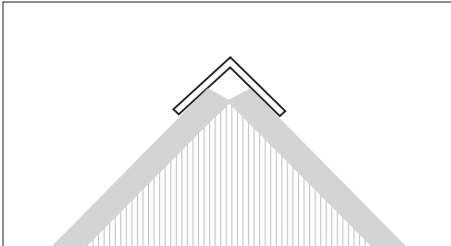







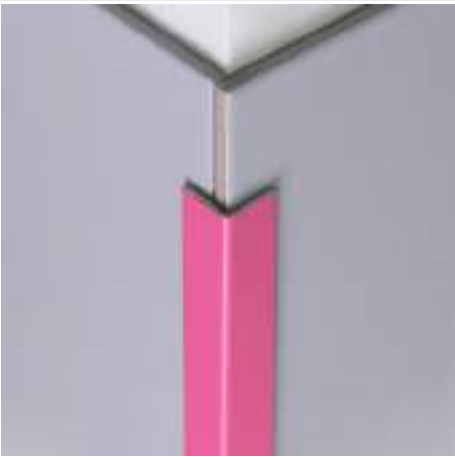





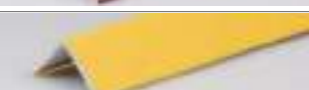



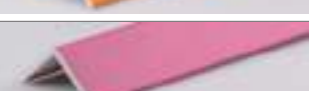











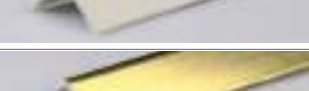

ANGO-PIETRA	Finitura - Finish	Caratteristiche	EAN	Cod.	BxH. (mm)	L. (m)	Conf. Carton	Min. ord.			
	 verniciato effetto pietra beige stone finishing painting beige	     	8013237143701	<b>875/101</b>	10 x 10		1,00	100	10		
			8013237144227	<b>875A/101</b>	10 x 10		1,00	100	10		
			8013237143763	<b>876/101</b>	15 x 15		1,00	100	10		
			8013237144234	<b>876A/101</b>	15 x 15		1,00	100	10		
			8013237143824	<b>877/101</b>	20 x 20		1,00	100	10		
			8013237144241	<b>877A/101</b>	20 x 20		1,00	100	10		
			8013237143886	<b>850D/101</b>	10 x 10		2,60	100	10		
			8013237143947	<b>851D/101</b>	15 x 15		2,60	100	10		
			8013237144005	<b>852D/101</b>	20 x 20		2,60	100	10		
				 verniciato effetto pietra sabbia stone finishing painting sand	     		8013237143718	<b>875/102</b>	10 x 10		1,00
8013237144258	<b>875A/102</b>	10 x 10				1,00	100	10			
8013237143770	<b>876/102</b>	15 x 15				1,00	100	10			
8013237144265	<b>876A/102</b>	15 x 15				1,00	100	10			
8013237143831	<b>877/102</b>	20 x 20				1,00	100	10			
8013237144272	<b>877A/102</b>	20 x 20				1,00	100	10			
8013237143893	<b>850D/102</b>	10 x 10				2,60	100	10			
8013237143954	<b>851D/102</b>	15 x 15				2,60	100	10			
8013237144012	<b>852D/102</b>	20 x 20				2,60	100	10			
	 verniciato effetto pietra cemento stone finishing painting concrete	     				8013237143725	<b>875/103</b>	10 x 10			1,00
			8013237145491	<b>875A/103</b>	10 x 10	1,00	100	10			
			8013237143787	<b>876/103</b>	15 x 15	1,00	100	10			
			8013237145507	<b>876A/103</b>	15 x 15	1,00	100	10			
			8013237143848	<b>877/103</b>	20 x 20	1,00	100	10			
			8013237145569	<b>877A/103</b>	20 x 20	1,00	100	10			
			8013237143909	<b>850D/103</b>	10 x 10	2,60	100	10			
			8013237143961	<b>851D/103</b>	15 x 15	2,60	100	10			
			8013237144029	<b>852D/103</b>	20 x 20	2,60	100	10			
											

ANGO-PIETRA	Finitura - Finish	Caratteristiche	EAN	Cod.	BxH. (mm)	L. (m)	Conf. Carton	Min. ord.							
	 verniciato effetto pietra antracite stone finishing painting anthracite	     	8013237143749	<b>875/105</b>	10 x 10		1,00	100	10						
			8013237145460	<b>875A/105</b>	10 x 10		1,00	100	10						
			8013237143800	<b>876/105</b>	15 x 15		1,00	100	10						
			8013237145477	<b>876A/105</b>	15 x 15		1,00	100	10						
			8013237143862	<b>877/105</b>	20 x 20		1,00	100	10						
			8013237145484	<b>877A/105</b>	20 x 20		1,00	100	10						
			8013237143923	<b>850D/105</b>	10 x 10		2,60	100	10						
			8013237143985	<b>851D/105</b>	15 x 15		2,60	100	10						
			8013237144043	<b>852D/105</b>	20 x 20		2,60	100	10						
			8013237143732	 verniciato effetto pietra fumo di Londra stone finishing painting london smoke	      		8013237143732	<b>875/104</b>	10 x 10		1,00	100	10		
			8013237144289				<b>875A/104</b>	10 x 10	1,00		100	10			
			8013237143794				<b>876/104</b>	15 x 15	1,00		100	10			
8013237144296	<b>876A/104</b>	15 x 15	1,00			100	10								
8013237143855	<b>877/104</b>	20 x 20	1,00			100	10								
8013237144302	<b>877A/104</b>	20 x 20	1,00			100	10								
8013237143916	<b>850D/104</b>	10 x 10	2,60			100	10								
8013237143978	<b>851D/104</b>	15 x 15	2,60			100	10								
8013237144036	<b>852D/104</b>	20 x 20	2,60			100	10								
8013237143695	 verniciato effetto pietra ruggine stone finishing painting rust	      	8013237143695			<b>875/100</b>	10 x 10		1,00		100	10			
8013237145521			<b>875A/100</b>			10 x 10	1,00		100		10				
8013237143756			<b>876/100</b>			15 x 15	1,00		100		10				
8013237145538			<b>876A/100</b>	15 x 15	1,00	100	10								
8013237143817			<b>877/100</b>	20 x 20	1,00	100	10								
8013237145545			<b>877A/100</b>	20 x 20	1,00	100	10								
8013237143879			<b>850D/100</b>	10 x 10	2,60	100	10								
8013237143930			<b>851D/100</b>	15 x 15	2,60	100	10								
8013237143992			<b>852D/100</b>	20 x 20	2,60	100	10								
															

ANGLEPLAST		Finish	Features	EAN	Cod.	BxH. (mm)	L. (m)	Conf. Carton	Min. ord.		
	Bianco satinato Satin white			8013237045227	045B1 / 01	FR 25 x 25	3,00	100	10		
				8013237045210	045B / 01	FR 25 x 25		100	10		
				8013237045319	045C / 01	33 x 33		100	10		
				8013237133009	045B1/01/1	25X25		100	10		
	Grigio chiaro light grey				8013237025427	045B1 / 03	FR 25 x 25	3,00	20	10	
					8013237045234	045B / 03	25 x 25		20	10	
					8013237028794	045C / 03	33 x 33		20	10	
					8013237035525	045C1/03	33 x 33		20	10	
	Nero satinato Satin black				8013237004996	045B1 / 15	FR 25 x 25	3,00	20	10	
					8013237035532	045C1/15	33 x 33		1,00	20	10
					8013237132866	045B1/15/1	25 x 25		1,00	20	10
Mogano satinato satin mahogany							1,00				
				8013237045265	045B1 / 41	25 x 25					
				8013237045258	045B / 41	25 x 25					
Noce chiaro satinato satin light walnut				8013237139681	045B1 / 40	25 x 25	3,00	20	10		
Noce scuro satinato satin dark walnut				8013237139698	045B1 / 42	25 x 25	3,00	20	10		
SPIGPLAST		Finish	Features	EAN	Cod.	BxH. (mm)	L. (m)	Conf. Carton	Min. ord.		
	Bianco satinato Satin white			8013237045418	045D1 / 01	22 x 22	3,00	100	10		
				8013237045517	045E / 01	29 x 29		100	10		
	Grigio chiaro light grey			8013237031800	045E / 03	29 x 29	3,00	20	10		
	Nero satinato Satin black										
	Mogano satinato satin mahogany										





FRIENDLY	Finitura - Finish	Caratteristiche	EAN	Cod.	BxH. (mm)	L. (m)	Conf. Carton	Min. ord.		
	 rivestito bianco coated white		8013237080563	1560B / 01	25 x 25	1,30	20	10		
	 rivestito verde pistacchio coated pistachio green									
	 rivestito rosso fuoco coated fire red									
	 rivestito giallo coated yellow									
	 rivestito arancio coated orange									
	 rivestito fucsia coated bright pink									
	 rivestito carta da zucchero coated sugar paper									
	 rivestito acero chiaro coated pale maple									
	 rivestito noce biondo coated blond walnut									
	 rivestito wengé coated wengé									
	 rivestito acero bianco coated white maple									
	 rivestito oro spazzolato coated brushed gold	 								
	 rivestito grigio fumo di Londra coated London smoke grey									
	 rivestito alluminio spazzolato coated brushed alu									
	 rivestito alluminio lucido coated polished alu	 								
 rivestito champagne spazzolato coated brushed champagne										

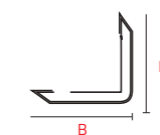
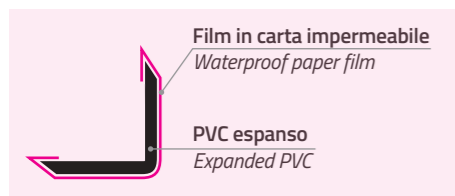
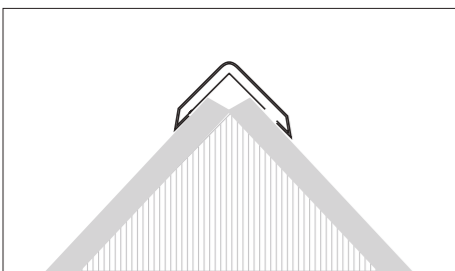



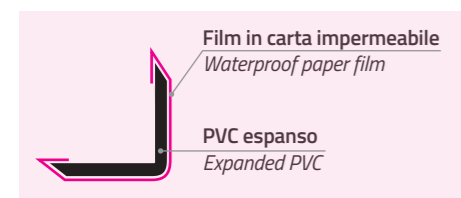
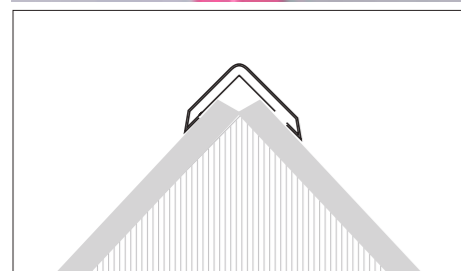
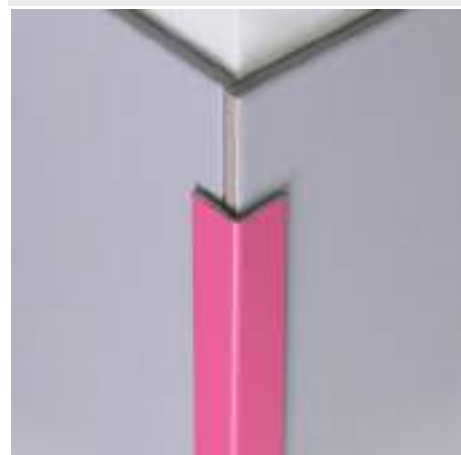



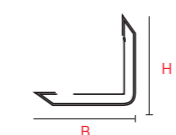

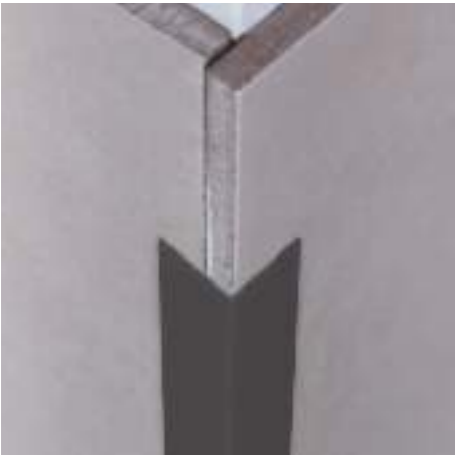
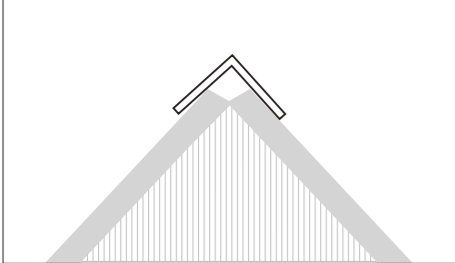







**FRIENDLY**



Finitura - Finish		Caratteristiche		EAN	Cod.	BxH. (mm)	L. (m)	Conf. Carton	Min. ord.		
	rivestito bianco coated white			8013237067977	1560A / 01	25 x 25	2,60	20	10		
	rivestito verde pistacchio coated pistachio green			8013237067724	1560A/ 12	25 x 25	2,60	20	10		
	rivestito rosso fuoco coated fire red			8013237067755	1560A/ 14	25 x 25	2,60	20	10		
	rivestito giallo coated yellow			8013237067731	1560A / 16	25 x 25	2,60	20	10		
	rivestito arancio coated orange			8013237067748	1560A/ 17	25 x 25	2,60	20	10		
	rivestito fucsia coated bright pink			8013237067762	1560A/ 18	25 x 25	2,60	20	10		
	rivestito carta da zucchero coated sugar paper			8013237067793	1560A/ 20	25 x 25	2,60	20	10		
	rivestito acero chiaro coated pale maple			8013237067892	1560A/ 133	25 x 25	2,60	20	10		
	rivestito noce biondo coated blond walnut			8013237067915	1560A/ 125	25 x 25	2,60	20	10		
	rivestito wengé coated wengé			8013237067939	1560A/ 131	25 x 25	2,60	20	10		
	rivestito acero bianco coated white maple			8013237067885	1560A/ 139	25 x 25	2,60	20	10		
	rivestito oro spazzolato coated brushed gold										
	rivestito grigio fumo di Londra coated London smoke grey			8013237067830	1560A/ 21	25 x 25	2,60	20	10		
	rivestito alluminio spazzolato coated brushed alu			8013237067960	1560A/ 90S	25 x 25	2,60	20	10		
	rivestito alluminio lucido coated polished alu										
	rivestito champagne spazzolato coated brushed champagne										



ANGOCOLOR	Finitura - Finish	Caratteristiche	EAN	Cod.	BxH. (mm)	L. (m)	Conf. Carton	Min. ord.
  	 <p>bianco lucido bright white</p>		8013237064334	1547E	FR 15 x 15	2,60	100	10
			8013237064341	1548E	FR 20 x 20		100	10
			8013237015152	1549E	25 x 25		100	10
			8013237064389	1557B	FR 30 x 30		100	10
			8013237064402	1558B	FR 40 x 40		100	10
			8013237064426	1559B	50 x 50		100	10
	 <p>nero lucido bright black</p>	   	8013237064365	1548G	20 x 20	2,60	20	10
			8013237064396	1557N	30 x 30		20	10
			8013237064419	1558N	40 x 40		20	10
	 <p>verde pistacchio lucido bright pistachio green</p>							
	 <p>grigio fumo lucido bright smoke grey</p>		8013237068356	1548E / 13	20 x 20	2,60	20	10
	 <p>rosso fuoco lucido bright fire red</p>							
	 <p>taupé lucido bright taupe</p>		8013237068363	1548E / 15	20 x 20	2,60	20	10



# Listelli

Decorative listello / Equerres de finition / Listeles

**Listelli:**

Il listello decorativo Arcansas è utilizzato per creare una linea elegante sul rivestimento in ceramica. Si abbina magnificamente agli accessori del bagno producendo esclusivi effetti cromatici. Disponibili in differenti dimensioni e finiture.

Viene realizzato per estrusione dell'alluminio e sottoposto all'ossidazione anodica per immersione in vasche elettrolitiche e successivamente nelle vasche del colore che viene poi fissato nelle ultime vasche del lungo processo anodico, dando vita ad uno strato protettivo che protegge il colore. Arcansas garantisce uno spessore del trattamento da 10 a 15 µm secondo il tipo di colore per la massima qualità di protezione. Arcansas impiega la lega 6060 per ottenere una colorazione costante per il massimo grado di finitura estetica oltre che funzionale.

**Decorative listello:**

Arcansas decorative listellos are used to create an elegant line on ceramic walls. They beautifully match with bathroom accessories and creates an exclusive chromatic effect. Available in different dimensions and finishing.

It is made by aluminium extrusion and then it is anodized by immersion in electrolytic tanks, creates a protective layer that protects the colour itself. Arcansas guarantees a treatment thickness from 10 to 15µm according to the type of colour for the maximum quality of protection. Arcansas uses alloy 6060 to obtain a constant colour and the highest level of aesthetic and functionally finishing.

**Equerres de finition :**







La bande décorative Arcansas est utilisée pour créer une ligne élégante sur le revêtement en carrelage. Il se combine merveilleusement bien avec des accessoires de salle de bain produisant des effets chromatiques exclusifs. Disponible en différentes tailles et finitions.

Il est fabriqué par extrusion d'aluminium et soumis à une oxydation anodique par immersion dans des réservoirs électrolytiques puis dans des baignoires de Couleur, qui est ensuite fixée dans les derniers réservoirs du long processus anodique, créant une couche protectrice qui protège la couleur. Arcansas garantit une épaisseur de traitement de 10 à 15 µm selon le type de couleur pour la meilleure qualité de protection. Arcansas utilise l'alliage 6060 afin d'obtenir une coloration brillante et uniforme pour une finition hautement esthétique et fonctionnelle.



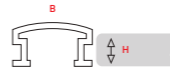

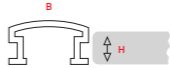



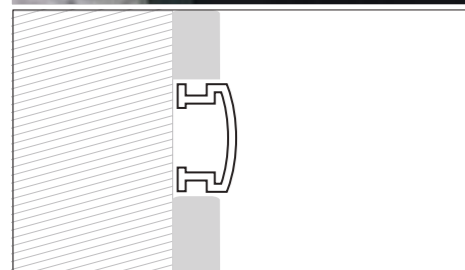

**Listeles:**

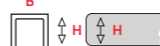
El listel decorativo Arcansas se utiliza para crear una línea elegante en el revestimiento cerámico. Se combina maravillosamente con accesorios de baño produciendo efectos cromáticos exclusivos. Disponible en diferentes medidas y acabados.





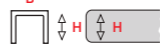



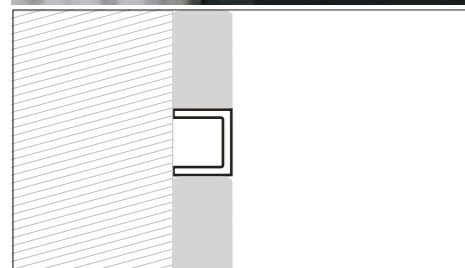

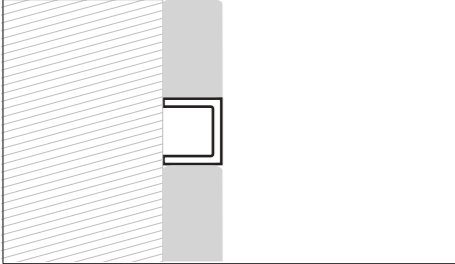





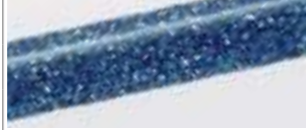







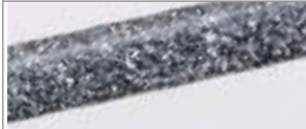







Se fabrica mediante extrusión de aluminio y se somete a oxidación anódica por inmersión en tanques electrolíticos y posteriormente en los tanques del color que luego se fija en los últimos tanques del largo proceso anódico, creando una capa protectora que protege el color. Arcansas garantiza un grosor del tratamiento de 10 a 15 µm según el tipo de color para la máxima calidad de protección. Arcansas utiliza la aleación 6060 para obtener una coloración constante para el más alto grado de acabado estético y funcional.

LISTALU	Finitura - Finish	Caratteristiche	EAN	Cod.	BxH. (mm)	L. (m)	Conf. Carton	Min. ord.	€/m	€/pz	
	argento anodizzato satinato satin anodised silver										
	argento anodizzato lucido polished anodised silver		8013237037260	039A	 15 x 8		2,70	100	5		
			8013237037284	040A	 25 x 8			100	5		



DEKOR-U	Finitura - Finish	Caratteristiche	EAN	Cod.		B x H (mm)	L. (m)	Conf. Carton	Min. ord.		
	argento anodizzato satinato satin anodised silver		8013237010133	1013		8 x 8		2,00	100	5	
			8013237010126	1012		10 x 10			100	5	
			8013237010102	1010		10 x 15			100	5	
			8013237101015	1010A		15 x 10			100	5	
			8013237010317	1011		10 x 20			100	5	
	oro anodizzato satinato satin anodised gold		8013237010027	1002		10 x 10		2,00	100	5	
	argento anodizzato lucido silver polished anodised		8013237510121	1012 / 93		10 x 10		2,00	100	5	
			8013237510107	1010 / 93		10 x 15			100	5	



GLITTER-U	Finitura - Finish	Caratteristiche	EAN	Cod.	B x H. (mm)	L. (m)	Conf. Carton	Min. ord.		
 	 glitter argento silver glitter	  								
	 glitter azzurro bright blue glitter	  								
	 glitter titanio titanium glitter	  								
	 glitter ardesia slate glitter	  								
	 glitter rame copper glitter	  								
	 glitter oro gold glitter	  								
	 glitter rame antico antique antique glitter	  								

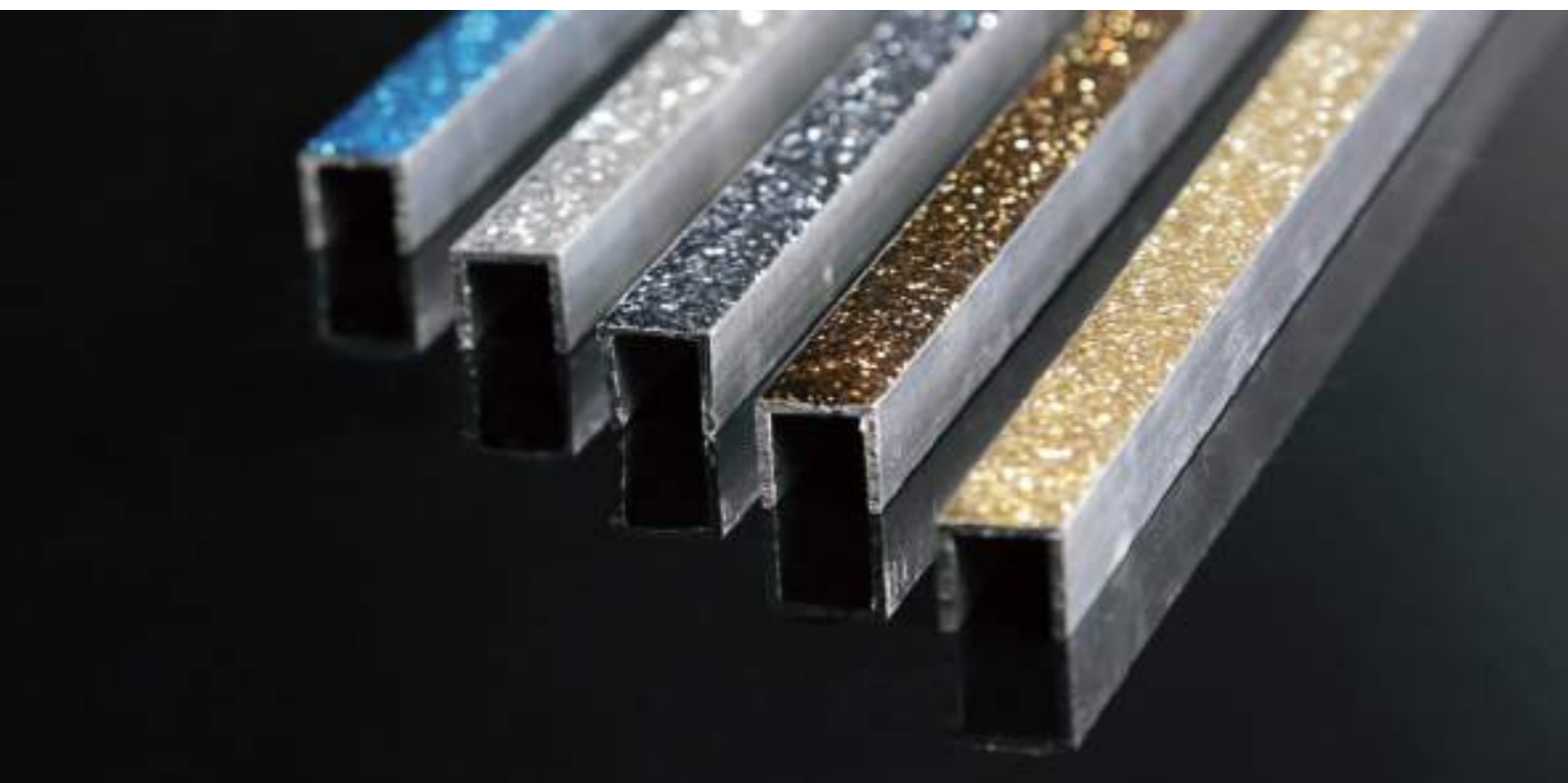



# Giunti di dilatazione

Expansion joints/ Joints de dilatation/ Juntas de expansión

## Giunti di dilatazione:

I giunti di dilatazione sono profili specificamente progettati per intervenire in maniera mirata sulle flessioni e compressioni della pavimentazione dovute principalmente alla costante pressione degli agenti atmosferici e ad escursione termica - in caso di superfici esterne - o ai continui movimenti della stessa pavimentazione che possono generare il prematuro distacco del rivestimento - anche in superfici interne.

La versatilità del profilo ne permette un'applicazione su diverse tipologie di pavimento, anche aventi diversa natura e spessore.

Si consiglia l'uso di giunti di dilatazione almeno ogni 15 Mq di superficie piastrellata.

## Expansion joints:

Expansion joints are profiles specifically designed to face the needs of thermal expansion and contraction in indoor and outdoor floors that can bring about detachment or damage to the coating. Arcansas expansion joints are very versatile and can be used in different types of floors, even with different thickness and material. The use of expansion joints is recommended at least every 15 square meters of tiled surface.

## Joints de dilatation :

Les joints de dilatation sont des profils spécifiquement conçus pour intervenir de manière ciblée sur les flexions et compressions du revêtement de sol dues principalement due à la pression constante des agents atmosphériques et à l'excursion thermique (dans le cas de surfaces externes) ou aux mouvements continus de ce même revêtement de sol qui peuvent engendrer le détachement prématuré du revêtement - même sur les surfaces internes.

La polyvalence du profil permet de l'appliquer à différent type de revêtements de sol, ayant également une nature et une épaisseur différentes.

Nous recommandons l'utilisation de joints de dilatation au moins tous les 15 mètres carrés de surface carrelée.

## Juntas de expansión:

Las juntas de expansión son perfiles diseñados específicamente para intervenir de manera específica en las flexiones y compresiones del suelo debido principalmente a la presión constante de los agentes atmosféricos y a la amplitud térmica - en el caso de superficies externas - o a los movimientos continuos de los mismos suelos que pueden generar despegue prematuro del revestimiento, incluso en superficies internas.

La versatilidad del perfil permite que se aplique a diferentes tipos de suelos, también con diferente naturaleza y grosor.

Recomendamos el uso de juntas de expansión al menos cada 15 metros cuadrados de superficie de baldosa.



ELASTOCER	Finitura- Finish	Caratteristiche	EAN	Cod.	H. (mm)	L. (m)	Conf Carton	Min. ord.	
	fuga grigia grey joint		8013237019570	259A	8		2,00	50	10
			8013237019600	259B	10		2,00	50	10
			8013237019631	259C	12		2,00	50	10
			8013237019662	259D	14		2,00	50	10
	fuga trasparente clear joint		8013237019587	259A1	8		2,00	50	10
			8013237019617	259B1	10		2,00	50	10
			8013237019648	259C1	12		2,00	50	10
			8013237019686	259D1	14		2,00	50	10

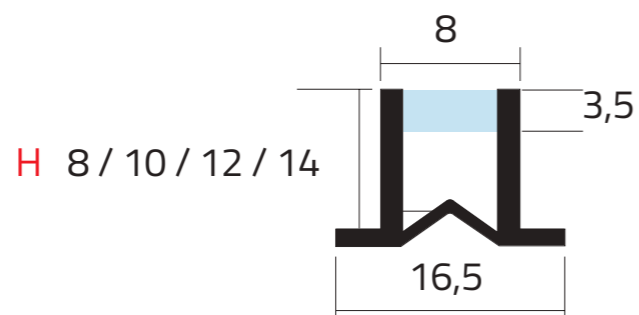



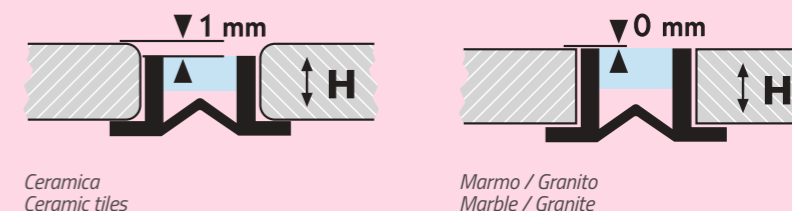

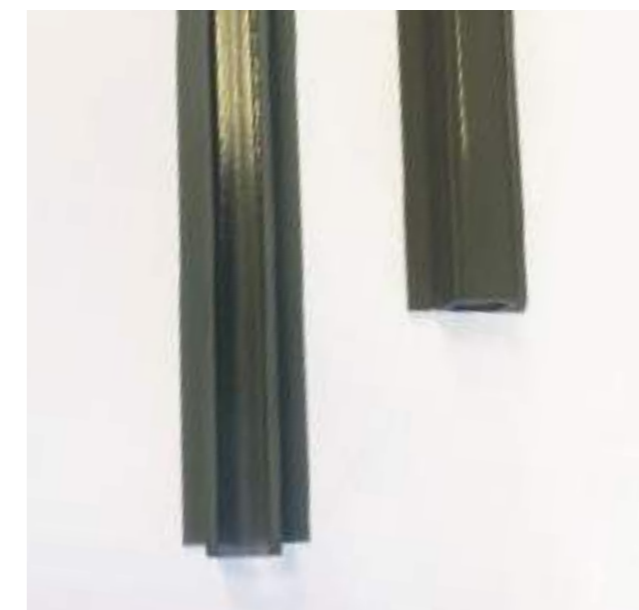
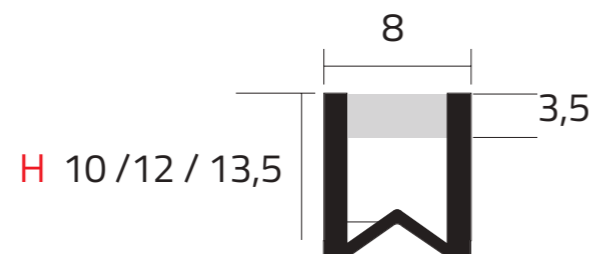

Metodo di posa / Installation method /



ELASTOCER/ S ALETTE	Finitura- Finish	Caratteristiche	EAN	Cod.	H. (mm)	L. (m)	Conf Carton	Min. ord.	
	fuga grigia grey joint		8013237142018	259F	8		2,00	50	10
			8013237071578	259E	10		2,00	50	10
			8013237071585	259G	12		2,00	50	10
			8013237133436	259L	13,5		2,00	50	10



DUOCER	Finitura- Finish	Caratteristiche	EAN	Cod.	H. (mm)	L. (m)	Conf Carton	Min. ord.		
	 fuga grigia grey joint		8013237020484	380C  8		2,50	50	10		
			8013237003807	380D  10		2,50	50	10		
			8013237020545	380E  12,5		2,50	50	10		

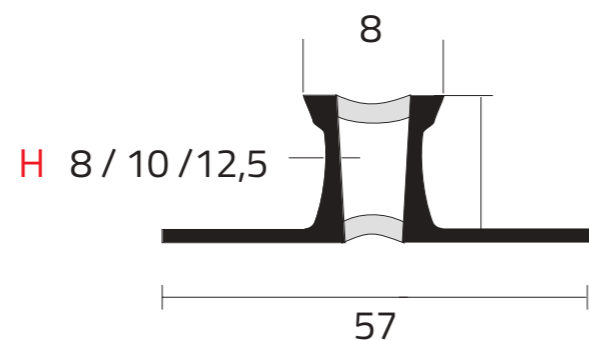

Metodo di posa / Installation method /

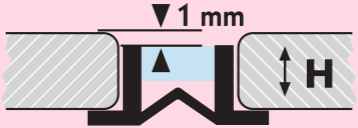





▼ 1 mm

Ceramica  
Ceramic tiles





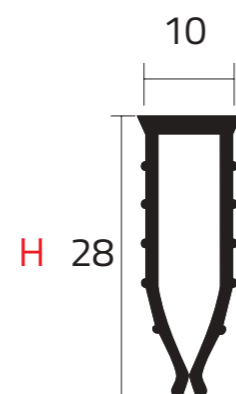

▼ 0 mm

Marmo / Granito  
Marble / Granite

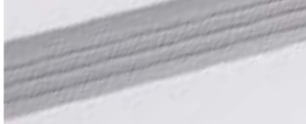
ECOCER	Finitura- Finish	Caratteristiche	EAN	Cod.	H. (mm)	L. (m)	Conf Carton	Min. ord.	€/m	€/pz
	 grigio satinato satin grey									

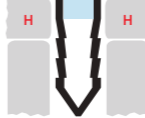

MOBICER	Finitura- Finish	Caratteristiche	EAN	Cod.	H. (mm)	L. (m)	Conf. Carton	Min. ord.		
	 fuga grigia grey joint		8013237019716	260A  25		2,50	50	10		
			8013237019785	260E  35		2,50	50	10		
			8013237148522	260D3  35		2,50	50	10		
	 fuga trasparente clear joint									

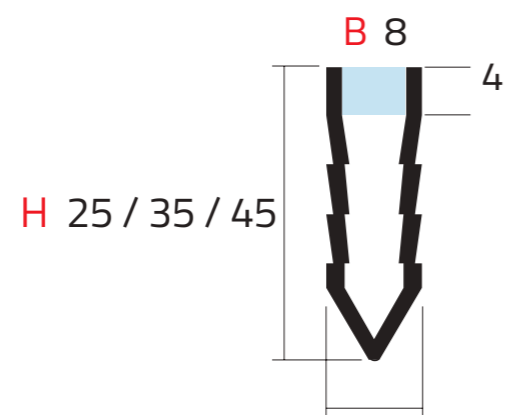

DUOLASTIC	Finitura- Finish	Caratteristiche	EAN	Cod.	BxH. (mm)	L. (m)	Conf. Carton	Min. ord.	€/m	€/pz	
	 fuga grigia grey joint										
	 fuga trasparente clear joint										
	 grigio satinato satin grey										

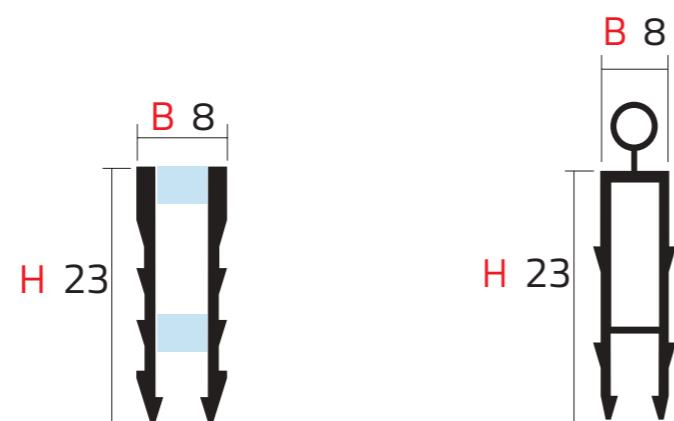



# Profili per top Cucina

Kitchen worktop cover profiles/ Profilés pour les plans de travail de cuisine/  
Perfiles para encimeras de cocina

## Profili per top cucina:

Profili progettati per integrare ogni tipologia di piano top definendo il contorno degli spazi. Queste profili vengono utilizzati principalmente per i collegamenti tra i piani di lavoro e la superficie della parete, ma possono essere applicati anche in altri luoghi dove è necessario mascherare le imperfezioni in giunzioni angolari delle superfici. Proteggendo contro l'intrusione di contaminanti e acqua.

## Vantaggi:

Impermeabile e antibatterico. Assicura una giunzione perfetta e sigillata.

## Kitchen worktop cover profiles:

These profiles are conceived to define worktop edges and design. They are mainly used as connection between worktop and walls, but they can also be used to cover any kind of corner connection between surfaces. They protect against the intrusion of contaminants and water.

## Advantages:

Waterproof and antibacterial. Ensures a perfect and sealed joint.

## Profilés pour les plans de travail de cuisine :

Profilés conçus pour intégrer chaque type de plan supérieur de travail en définissant le contour des espaces. Ces profilés sont principalement utilisés pour les connexions entre les surfaces de travail et la surface du mur, mais ils peuvent également être appliqués dans d'autres endroits où il est nécessaire de masquer les imperfections dans les joints d'angle des surfaces. Ils protègent contre l'intrusion de contaminants et de l'eau.

## Avantages:

Imperméable et antibactérien. Assure un joint parfait et étanche.

## Perfiles para encimeras de cocina:

Perfiles diseñados para integrar cada tipo de encimera definiendo el contorno de los espacios. Estos perfiles se utilizan principalmente para las conexiones entre las superficies de trabajo y la superficie de la pared, pero también se pueden aplicar en otros lugares donde es necesario esconder imperfecciones en las esquinas de las superficies. Protegen contra la intrusión de contaminantes y agua.

## Ventajas:

Impermeable y antibacteriano. Asegura una unión perfecta y sellada.

MIGNONALU	Finitura -Finish	Caratteristiche	EAN	Cod.	BxH. (mm)	L. (m)	Conf. Carton	Min. ord.			
	 argento anodizzato spazzolato brushed anodised silver		8013237058517	044 / 90S	15 x 15	3,00	50	10			
			8013237064303	044E / 90S	15 x 15	2,50	50	10			
	 argento anodizzato lucido polished anodised silver		8013237067045	044E / 93	15 x 15	2,50	50	10			
	 argento anodizzato satinato anodised satin silver										

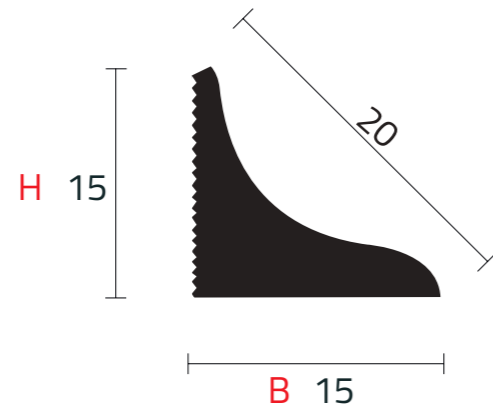
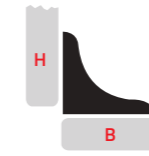

SGUSCIALU	Finitura -Finish	Caratteristiche	EAN	Cod.	BxH. (mm)	L. (m)	Conf. Carton	Min. ord.		
	 argento anodizzato spazzolato brushed anodised silver		8013237069803	044G / 90S	9 x 16	3,00	50	10		

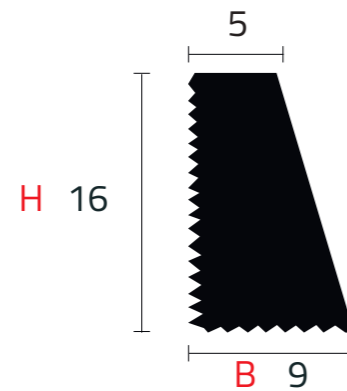
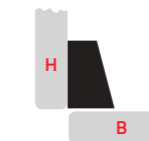

**KIT MIGNONALU**



Finitura - Finish	Caratteristiche		EAN	Cod.	Numero barre Number of profiles	Taglio Cut	Destinazione intended use	L. (m)		Conf. kit	Min. ord. Kit

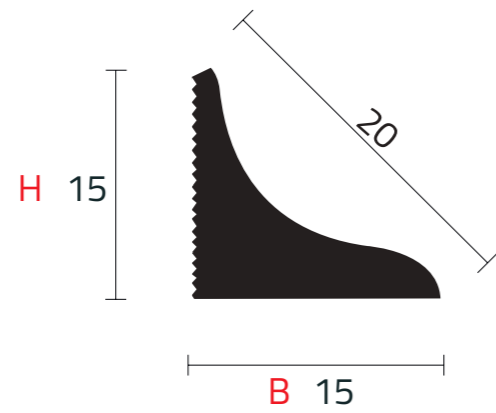



# Profili di raccordo igienico

Sanitary-wear profiles/ Profilés de connections hygiéniques /  
Perfiles de conexión higiénica

## Profili di raccordi igienico:

Sono profili progettati per risolvere ogni esigenza di raccordo igienico raggiato tra pavimento e parete secondo le norme igienico sanitarie europee. Si caratterizza per la semplicità di posa. Il materiale utilizzato è una speciale e pregiata composizione plastica atta ad ottenere un aspetto lucido brillante a tutto corpo, donandole un effetto porcellanato. Non pulire con materiale abrasivo.

## Vantaggi:

Non teme raggi UVA, graffi, detersivi. Può essere impiegato anche in esterno.

## Sanitary-wear profiles:

These profiles are designed to satisfy every need in terms of connection between floor and walls according to European health and hygiene standards. Easy to install, it is made by a special and fine plastic melt conceived to obtain a shiny bright porcelain look. Do not clean with abrasive materials.

## Advantages:

Resistant to UV rays, scratches and detergents it can also be used outdoors.

## Profilés de connections hygiéniques :

Ces profilés sont conçus pour répondre à tous besoin d'une connection hygiénique arrondie entre le sol et le mur conformément aux normes sanitaires européennes. Ils se caractérisent par la simplicité d'installation. Le matériau utilisé est une composition plastique spéciale et précieuse qui donne un aspect brillant, un effet porcelaine. Ne pas nettoyer avec un matériau abrasif.

## Avantages:

Il ne craint pas les rayons UVA, les rayures, les détergents. Il peut également être utilisé à l'extérieur.

## Perfiles de conexión higiénica:



Estos perfiles están diseñados para resolver cualquier necesidad de una conexión higiénica redondeada entre el piso y la pared de acuerdo con las normas sanitarias europeas. Se caracteriza por la facilidad de instalación. El material utilizado es una composición plástica especial y preciosa capaz de obtener una apariencia brillante completa, dándole un efecto de porcelana. No limpiar con material abrasivo.

## Ventajas:

No teme a los rayos UVA, arañazos, detergentes. Se puede alpicar tambien al exterior.

RACCORDINOX



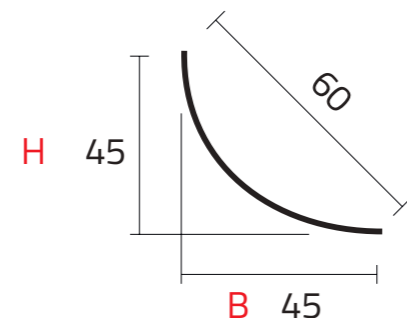

Finitura -Finish	Caratteristiche	EAN	Cod.	BxH. (mm)	L. (m)	Conf. Carton	Min. ord.	€/m	€/pz
 acciaio inox lucido AISI 304 polished stainless steel AISI 304		8013237704186	<b>070D18</b>	45 x 45	2,50	10	5	16,84	*



SGUSCINOX



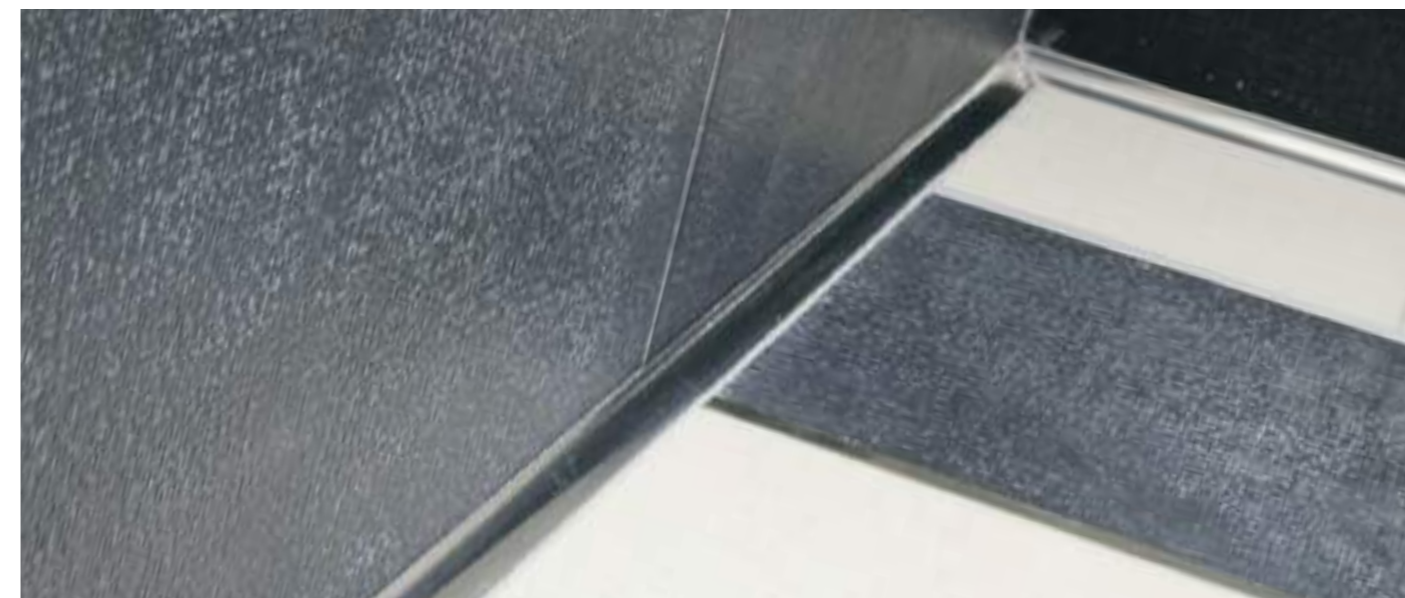
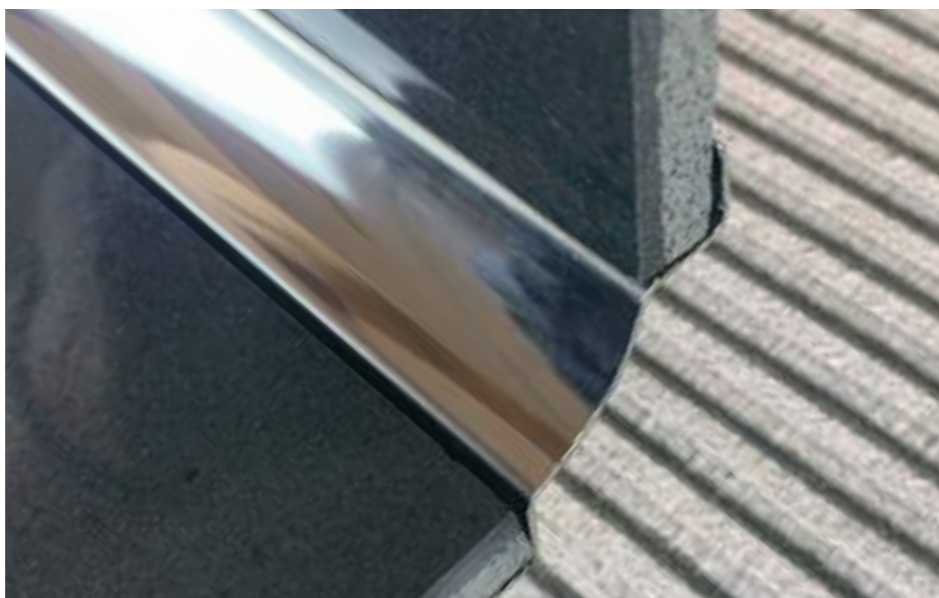

Finitura -Finish	Caratteristiche	EAN	Cod.	HxH. (mm)	L. (m)	Conf. Carton	Min. ord.	€/m	€/pz
 acciaio inox lucido AISI 304 polished stainless steel AISI 304	 	8013237031701	<b>071D7</b>	FR 8 x 10	2,50	10	5	16,86	**
		8013237070465	<b>070D6</b>	FR 10 x 10	2,50	10	5	17,00	**



SOTTOPOSA - UNDERTILE

\* Profili compatibili con angoli a pag. 208  
 Profiles compatible with corners at pag. 208





Finitura - finish		Caratteristiche	EAN	Cod.	BxH. (mm)	L. (m)	Conf. Kit	Min. ord. Kit		*
	angolo a 3 vie 3-way corner	acciaio inox lucido AISI 304 polished stainless steel AISI 304								
	angolo esterno outside corner									
	angolo interno inside corner									











Conf. Kit 1 pz



\*Angoli 2/3 vie  
\*2/3 ways connection

Finitura - finish		Caratteristiche	EAN	Cod.	HxH. (mm)	L. (m)	Conf. Kit	Min. ord. Kit		** *
	angolo a 3 vie 3-way corner	acciaio inox lucido AISI 304 polished stainless steel AISI 304								
	angolo esterno outside corner									
	angolo interno inside corner									

\*\*Angoli 2/3 vie  
\*\*2/3 ways connection

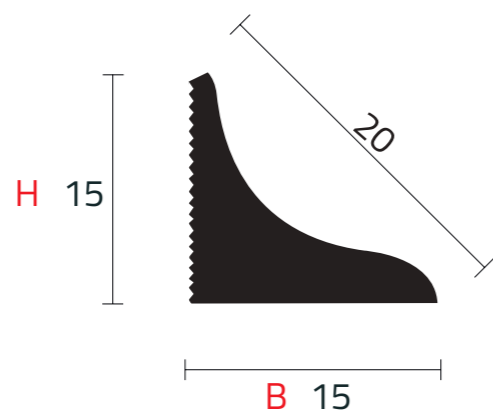
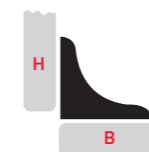
MIGNONALU	Finitura -Finish	Caratteristiche	EAN	Cod.	BxH. (mm)	L. (m)	Conf. Carton	Min. ord.
	 argento anodizzato spazzolato brushed anodised silver		8013237058517	044 / 90S 	15 x 15	3,00	50	10
			8013237064303	044E / 90S	15 x 15	2,50	50	10
	 argento anodizzato lucido polished anodised silver		8013237067045	044E / 93	15 x 15	2,50	50	10
 argento anodizzato satinato anodised satin silver								





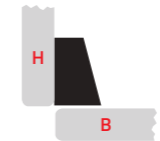
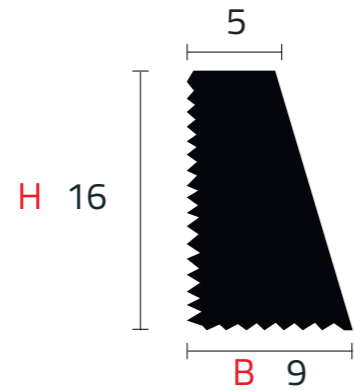



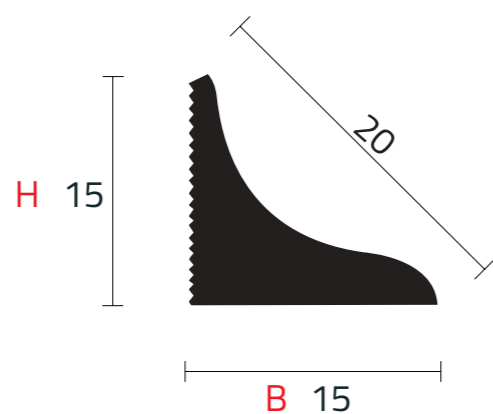





SGUSCIALU	Finitura -Finish	Caratteristiche	EAN	Cod.	BxH. (mm)	L. (m)	Conf. Carton	Min. ord.		
	 argento anodizzato spazzolato  brushed anodised silver		8013237069803	044G / 90S	9 x 16	3,00	50	10		







KIT MIGNONALU	Finitura - Finish	Caratteristiche	EAN	Cod.	Numero barre Number of profiles	Taglio Cut	Destinazione intended use	L. (m)		Conf. Kit	Min. ord. Kit	
	alluminio argento spazzolato brushed silver alu	 										
		 										
		 										
	anodizzato lucido	 										
	alluminio argento spazzolato	 										
	anodizzato satinato	 										



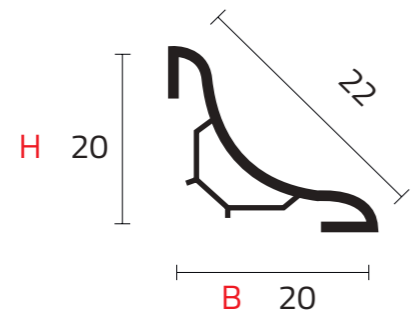
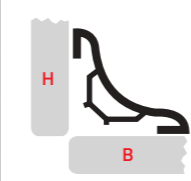







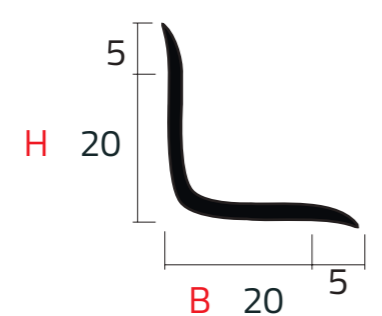
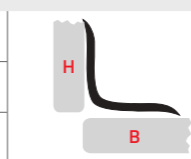



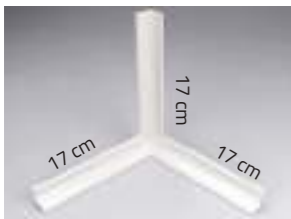















RACCORDMIGNON	Finitura - Finish	Caratteristiche	EAN	Cod.	BxH. (mm)	L. (m)	Conf. Carton	Min. ord.		
	 bianco lucido bright white		8013237062682	081V / 01 / B <span style="border: 1px solid black; border-radius: 50%; padding: 2px;">FR</span>	20 x 20	2,50	20	10		*
	 bianco lucido bright white		8013237013387	081V / 01	20 x 20	2,50	20	10		*
			8013237066208	082 / 01	20 x 20	1,25	20	10		*
	 bianco lucido bright white		8013237025731	081VA / 01	20 x 20	2,50	20	10		*
 grigio lucido bright grey	 grigio lucido bright grey									
	 grigio lucido bright grey									
 beige lucido bright beige	 beige lucido bright beige									



COPRISIL	Finitura - Finish	Caratteristiche	EAN	Cod.	BxH. (mm)	L. (m)	Conf. Carton	Min. ord.		
	 bianco satinato satin white									
			8013237019112	255	20 x 20	3,00	20	10		



\* Profili compatibili con angoli a pag. 220-222  
Profiles compatible with corners at pag. 220-222

Finitura - Finish		Caratteristiche	EAN	Cod.	BxH. (mm)	L. (m)	Conf. Kit	Min. ord. Kit		
 <p>angolo a 3 vie 3-way corner</p>	bianco white	 								
	grigio grey	 								
	beige	 								
	beige	 								
 <p>spigolo corner</p>	bianco white	 								
	grigio grey	 								
	beige	 								
	beige	 								
 <p>angolo interno inside corner</p>	bianco white	 								
	grigio grey	 								
	beige	 								
	beige	 								

\*Angoli 2/3 vie  
\*2/3 ways connection

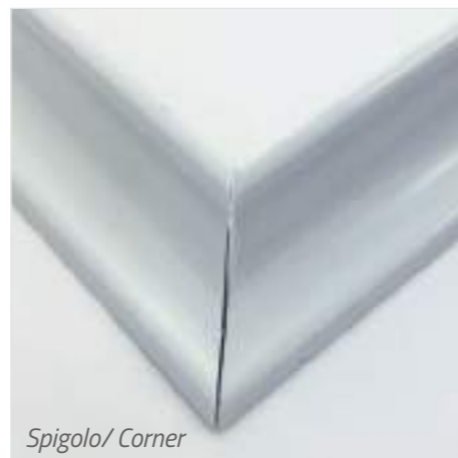
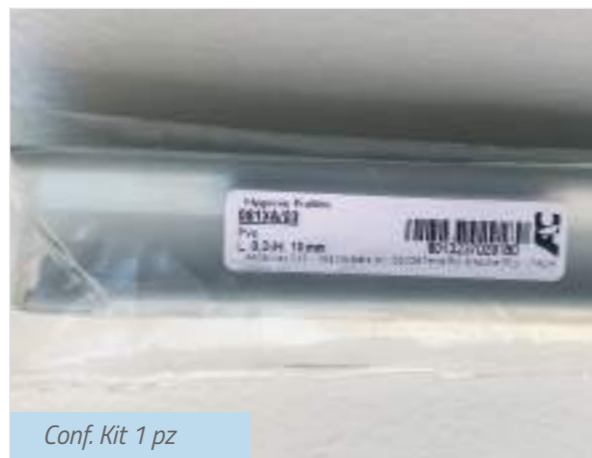

\*Tappo chiusura  
\*End cap

EAN	Cod.	Min. ord.	pz.
8013277031756	081B/ 01	10	1



Cod. 081B1/01

\*Spigolo 2 vie  
\*2 ways edge

EAN	Cod.	Min. ord.	pz.
8013237050849	081B1 / 01	10	1



Cod. 081B2/01

\*Tappo 2/3 vie  
\* 2/3 ways cap

EAN	Cod.	Min. ord.	pz.
8013237144593	081B2/ 01	10	1



\*Angolo 2 vie  
\*2 ways connection

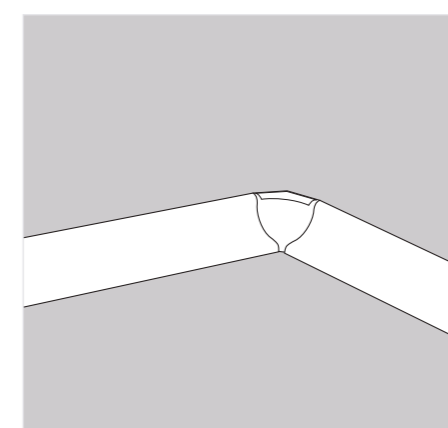
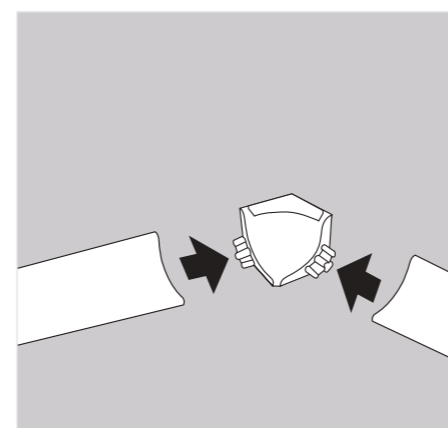

\*Angolo 2 vie  
\*2 ways connection



\*Angolo 3 vie  
\*3 ways connection

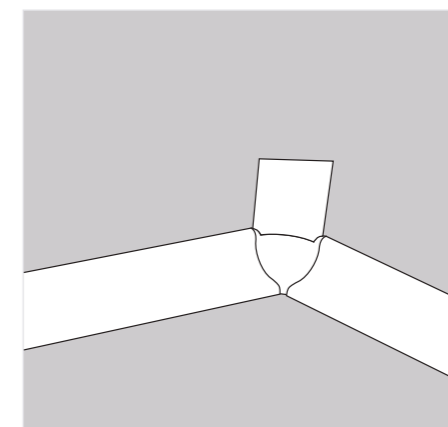
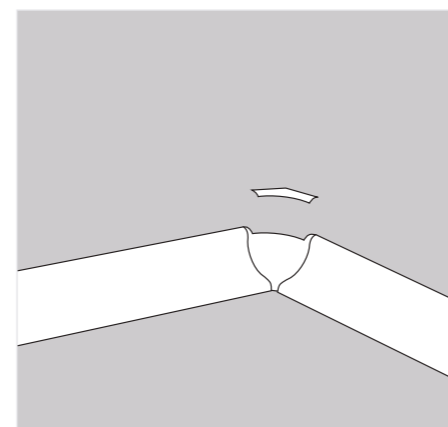

\*Angolo 3 vie  
\*3 ways connection



Rimozione linguetta  
per realizzazione  
angolo a 3 vie.  
Tab removal for 3-way corner  
construction.

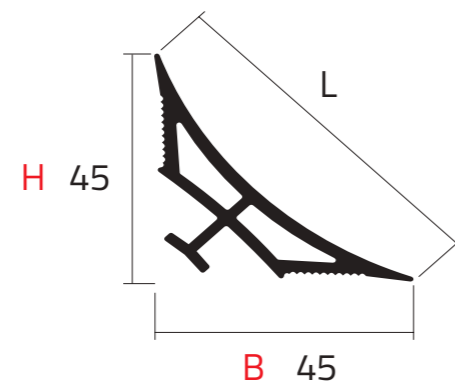
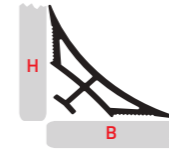

RACCORDPIVI	Finitura - Finish	Caratteristiche	EAN	Cod.	BxH. (mm)	L. (m)	Conf. Carton	Min. ord.		*
	 bianco lucido bright white		8013237010898	070D17 / 01	45 x 45	2,00	20	10		
	 grigio lucido bright grey									
	 beige lucido bright beige									

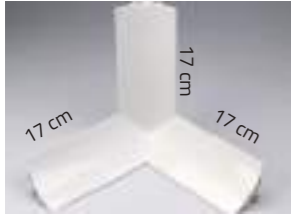
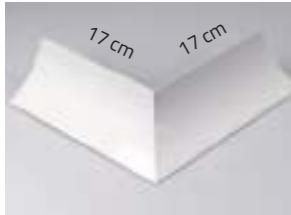

\* Profili compatibili con angoli a pag. 226  
Profiles compatible with corners at pag. 226

Finitura - Finish		Caratteristiche	EAN	Cod.	BxH. (mm)	L. (m)	Conf. Kit	Min. ord. Kit		
	angolo a 3 vie 3-way corner	bianco white								
		grigio grey								
		beige beige								
	angolo esterno outside corner	bianco white								
		grigio grey								
		beige beige								
	angolo interno inside corner	bianco white	8013237704827	<b>070D17B / 01</b>	-	-	1	5		
		grigio grey								
		beige beige								

\*Angoli 2/3 vie  
\*2/3 ways connection



SOTTOPOSA - UNDERTILE

SGUSCIPIVI	Finitura - Finish	Caratteristiche	EAN	Cod.	HxH. (mm)	L. (m)	Conf. Carton	Min. ord.		*	
	 bianco lucido bright white		8013237011093	070D17A / 01	10 x 10	2,50	20	10			
			8013237011567	070D3 / 01	8 x 15	2,50	20	10			
	 grigio lucido bright grey										
	 beige lucido bright beige										

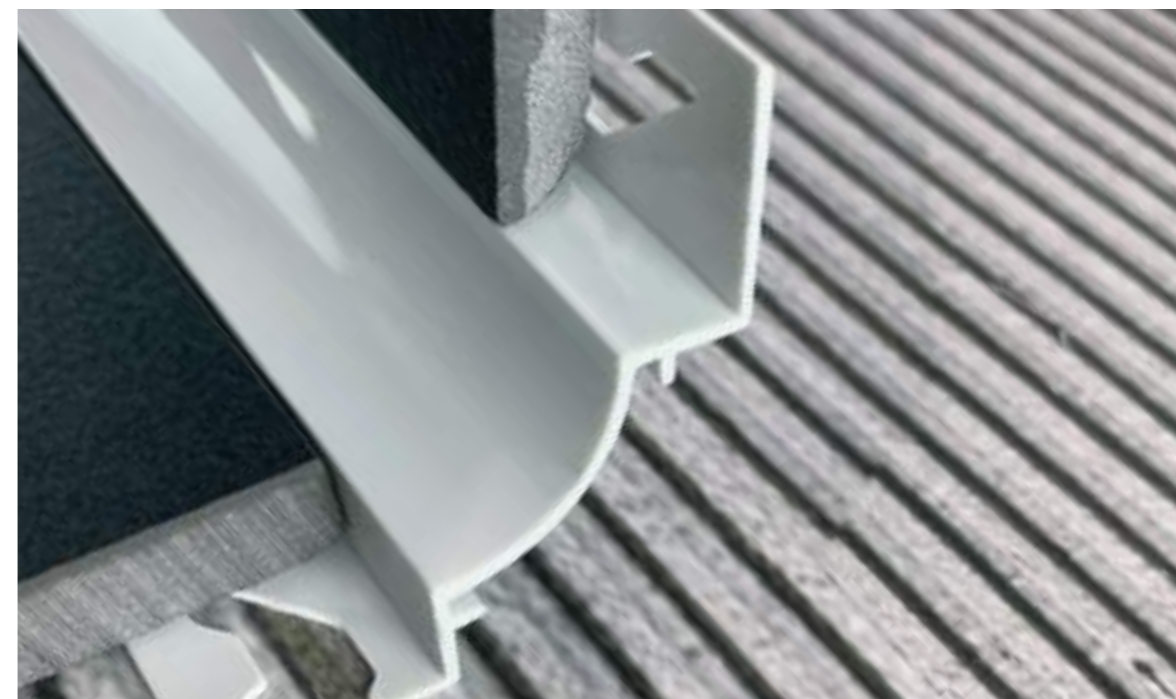
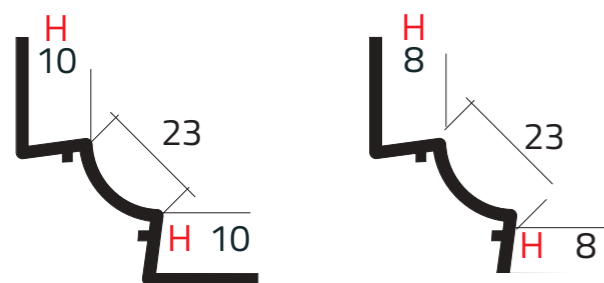
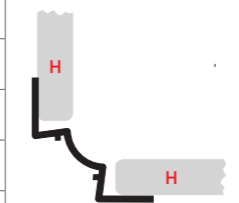

\* Profili compatibili con angoli a pag.230  
Profiles compatible with corners at pag. 230

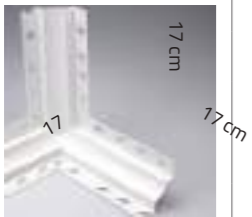
Finitura - Finish		Caratteristiche	EAN	Cod.	HxH. (mm)	L. (m)	Conf.Kit	Min. ord. Kit		*	
	angolo a 3 vie 3-way corner	bianco white									
		grigio grey									
		beige beige									
	angolo esterno outside corner	bianco white									
		grigio grey									
		beige beige									
	angolo interno inside corner	bianco white									
		grigio grey									
		beige beige									

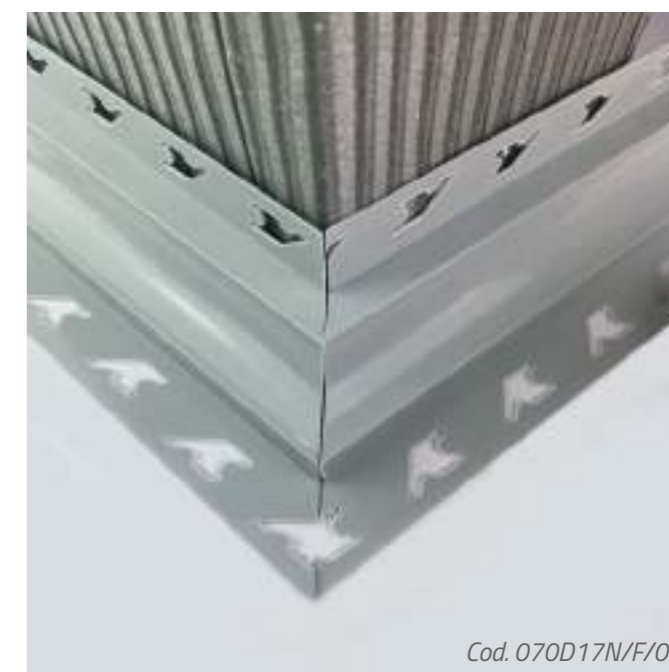
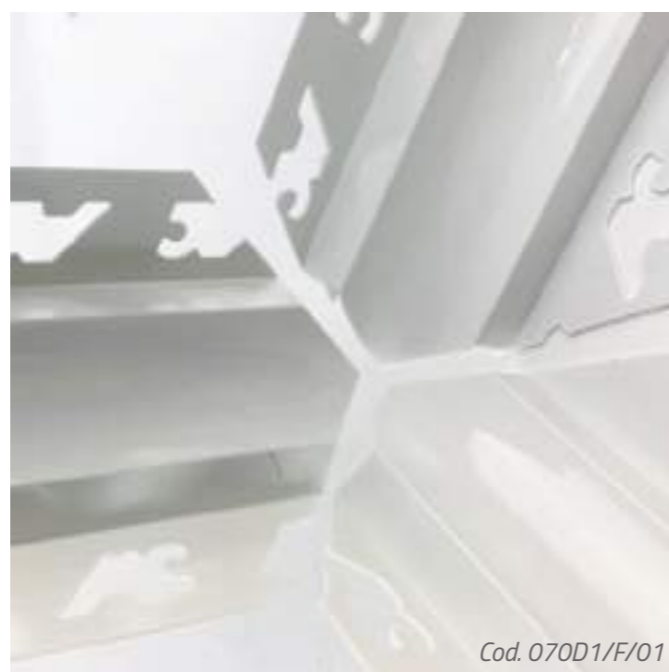

\*Angoli 2/3 vie  
\*2/3 ways connection



SOTTOPOSA - UNDERTILE

SGUSCIAMONO





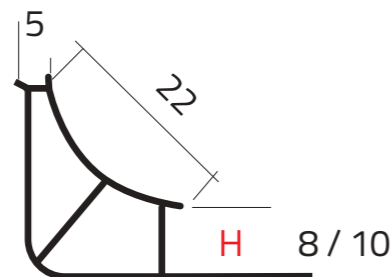

Finitura - Finish	Caratteristiche	EAN	Cod.	H. (mm)	L. (m)	Conf. Carton	Min. ord.
 bianco satinato satin white							

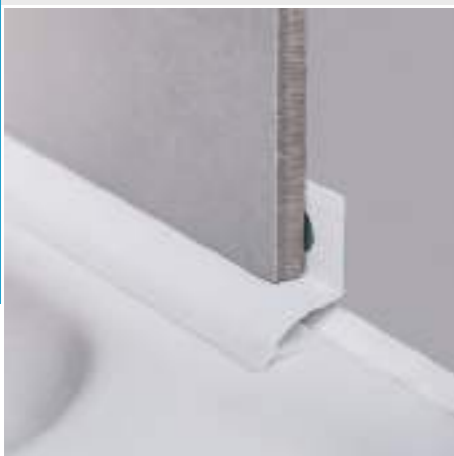

SOTTOPOSA - UNDERTILE

SOTTOSIL





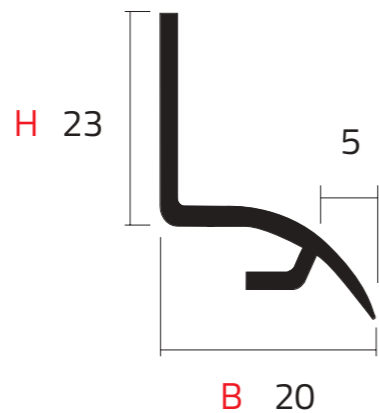

Finitura - Finish	Caratteristiche	EAN	Cod.	BxH. (mm)	L. (m)	Conf. Carton	Min. ord.	€/m	€/pz
 bianco satinato satin white									



SOTTOPOSA - UNDERTILE

SGUSCETTA-ECO



Finitura - Finish	Caratteristiche	EAN	Cod.	H. (mm)	L. (m)	Conf. Carton	Min. ord.
 bianco satinato satin white		8013237136109	081E / M / 01	8	2,50	20	10
		8013237136116	081L / M / 01	10		20	10
 beige satinato satin beige		8013237136123	081E / M / 17	8		20	10
		8013237136093	081L / M / 17	10		20	10



SOTTOPOSA - UNDERTILE



Finitura - Finish		Caratteristiche	EAN	Cod.	H. (mm)		L. (m)	Conf. Carton	Min. ord.		
	bianco lucido bright white		8013237012830	081E / 01		8	2,50	20	10		
			8013237012977	081L / 01		10					
	grigio chiaro lucido bright pale grey										
	grigio scuro satinato satin dark grey										
	avorio satinato satin ivory										
	celeste satinato satin pale blue										
	beige bahama satinato satin bahama beige										
	verde guatemala satinato satin guatemala green										
	nero-oro satinato satin black-gold										
	bianco satinato satin white										
	celeste satinato satin pale blue										
	grigio satinato satin grey										
	beige satinato satin beige										
	verde chiaro satinato satin pale green										
	azzurro satinato satin bright blue										

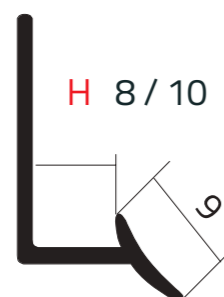
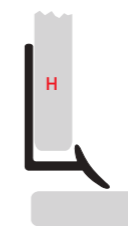
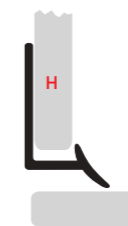

**KIT RACCORDMIGNON**



EAN	Cod.	Caratteristiche	Finitura - Finish	Destinazione Intended use	Taglio Cut	Numero barre Number of profiles	L. (m)	Conf. Kit	Min. ord. Kit	
8013237042141	081XB / 01		porcellanato - porcelain		45° + terminali / sloped cover strips	2 barre / 2 profiles	2	1	5	
8013237067298	083 / 01					45°	2 barre / 2 profiles	1,25	1	5
8013237066215	083A / 01					45°	2 barre adesive / 2 adhesive profiles	1,25	1	5
8013237066390	081XCB / 01					45°	2 barre + 1 barra / 2 profiles + 1 profile / 2	1,25 / 2,5	1	5

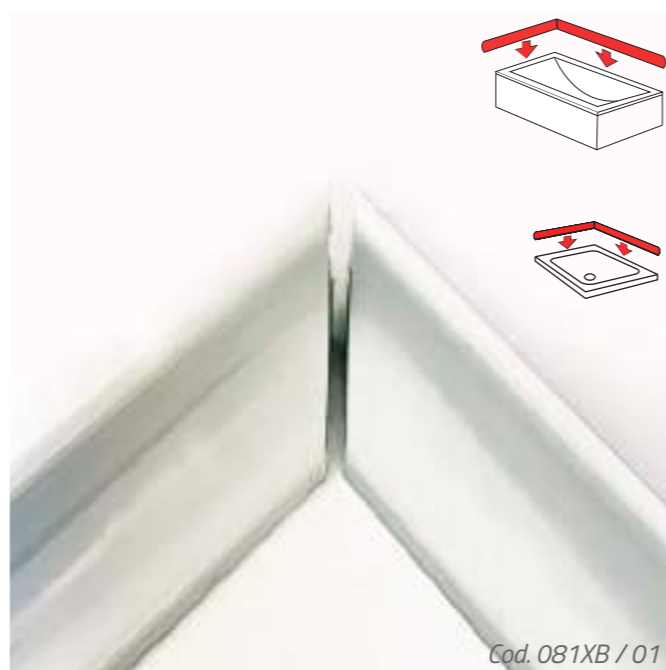
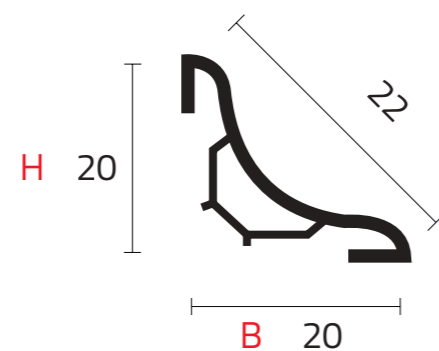
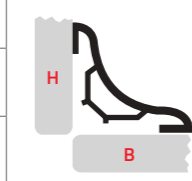





# Drenaggio

Drainage/ Drainage/ Drenaje

## Drenaggio:

I canali doccia Arcansas arricchiscono le nostre proposte in fatto di dispositivi di drenaggio.

Moderni, eleganti, ideali per docce, bagni, saune, piscine, centri benessere, palestre o impianti sportivi.

Canali e griglie sono prodotti in acciaio inox AISI 304 EN 1.4301, in 5 lunghezze da 60 a 100cm. Tutti i modelli sono conformi alla normativa EN 274-1: 2002 e sono adatti per rivestimenti con altezza massima fino a 15 mm.

## Vantaggi:

I canali doccia offrono un miglior drenaggio. Ottima Impermeabilità. Adattamento a qualsiasi bagno e ad ogni esigenza personale.

## Drainage:

Arcansas drainage channels complete our range of drainage devices.

Innovative, stylish, ideal for showers, bathrooms, swimming pools, spas, gyms and sports facilities.

Water collection channel and grilles are made from AISI 304 EN 1.4301 stainless steel and are available in 5 different lengths from 60 to 100cm. All models comply with EN 274-1: 2002 standards and are suitable for covering tiles up to 15mm.

## Advantages:

Shower channels offer a better water drainage. Excellent waterproofness. Easy-going solution for any kind of ambience and personal need.

## Drainage :

Les caniveaux de douche Arcansas enrichissent nos propositions en termes de dispositifs de drainage. Modernes, élégants, idéals pour les douches, salles de bain, saunas, piscines, spas, gymnases ou installations sportives.

Les canaux et les grilles sont fabriqués en acier inoxydable AISI 304 EN 1.4301, en 5 longueurs de 60 à 100 cm. Tous les modèles sont conformes à la norme EN 274-1: 2002 et conviennent aux revêtements d'une hauteur maximale de 15 mm.

## Avantages:

Les caniveaux de douche offrent un meilleur drainage. Excellente imperméabilité. Adaptation à toute salle de bain et à chaque besoin personnel.

## Drenaje:

Las canaletas de ducha Arcansas enriquecen nuestras propuestas en términos de dispositivos de drenaje. Modernas, elegantes, ideales para duchas, baños, saunas, piscinas, spas, gimnasios o instalaciones deportivas.

Las canaletas y rejillas se producen en acero inoxidable AISI 304 EN 1.4301, en 5 longitudes de 60 a 100 cm. Todos los modelos cumplen con la norma EN 274-1: 2002 y son adecuados para recubrimientos con una altura máxima hasta 15 mm.

## Ventajas:

Las canaletas de ducha ofrecen un mejor drenaje. Excelente impermeabilización. Adaptación a cualquier baño y a cada necesidad personal.

**CANALINA A PAVIMENTO PER DOCCIA BALI**



Finitura - Finish	EAN	Cod.	misura (cm)	Min. ord.	Conf. Carton
 acciaio inox AISI 304 spazzolato  AISI 304 brushed s.steel					

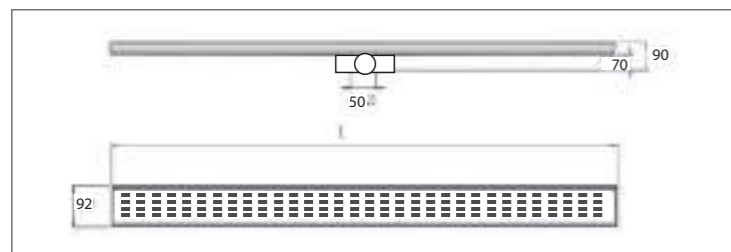

**CANALINA A PAVIMENTO PER DOCCIA SYDNEY**



Finitura - Finish	EAN	Cod.	misura (cm)	Min. ord.	Conf. Carton
 acciaio inox AISI 304 spazzolato  AISI 304 brushed s.steel					

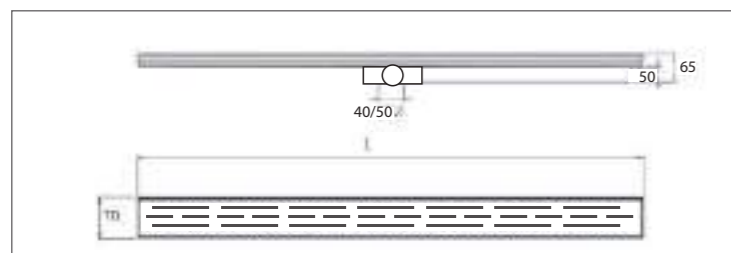

**CANALINA A PAVIMENTO PER DOCCIA SANTIAGO**

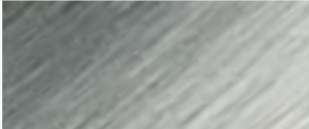

Finitura - Finish	EAN	Cod.	misura (cm)	Min. ord.	Conf. Carton
 acciaio inox AISI 304 spazzolato  AISI 304 brushed s.steel					

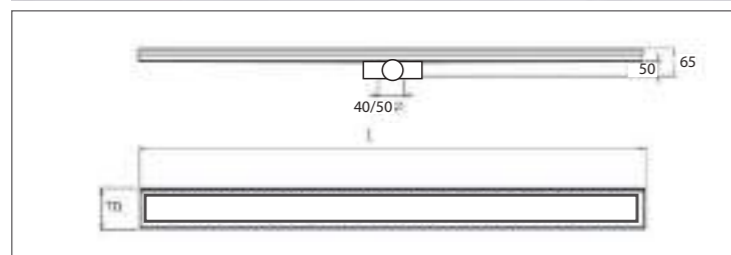



MENSOLA PER PARETI PIASTRELLATE

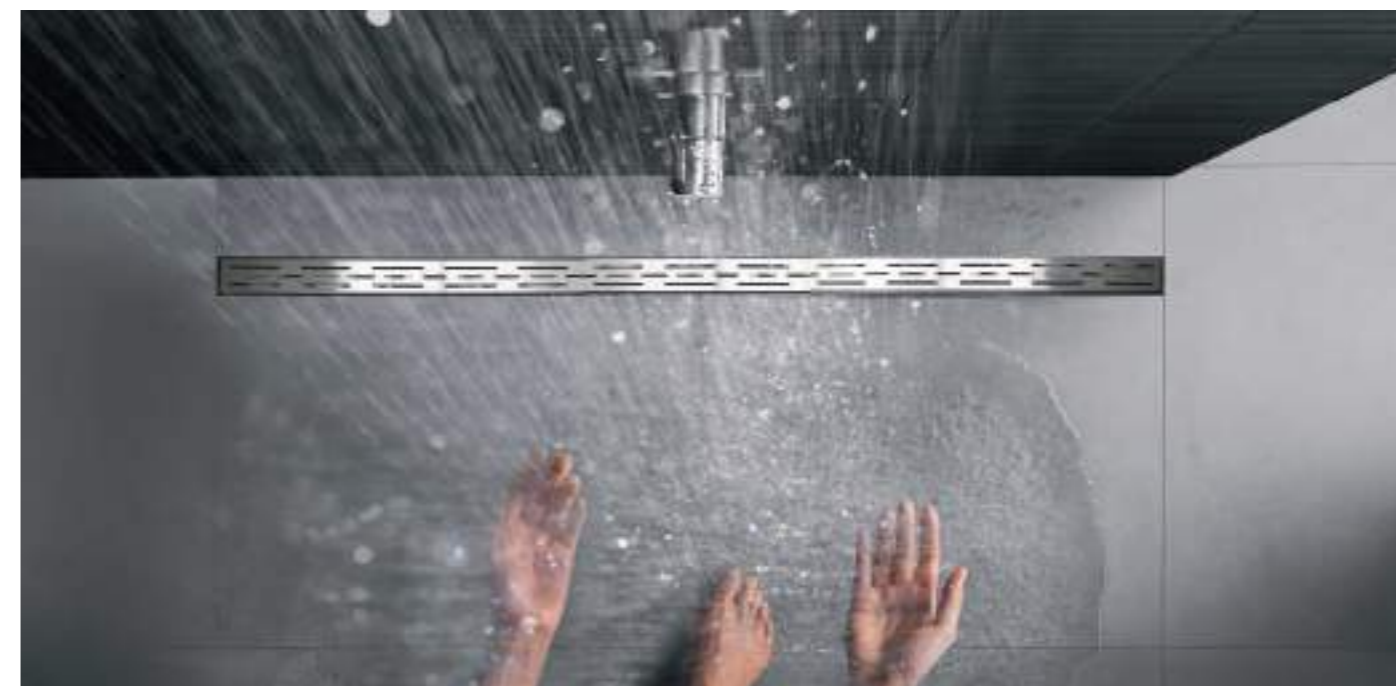

Finitura - Finish	EAN	Cod.	misura (cm)	Min. ord.	Conf. Carton
 acciaio inox AISI 304 spazzolato AISI 304 brushed s.steel					



## Arcansas LAY / MEMBRANA ISOLANTE

	Cod.	EAN	Descrizione	Min. ord.	€/pz
	GU/500 	8013237140311	Membrana isolante	1m x 30m= 30 m <sup>2</sup>	450,25



# Arcansas® LAY

## MODALITÀ DI POSA

1. La superficie di applicazione deve essere liscia e priva di residui che possano comprometterne l'adesione. Se necessario, livellare la superficie prima di posare Arcansas LAY.
2. Il collante con il quale fissare la guaina Arcansas LAY al supporto deve essere adeguato al tipo di supporto stesso. Di norma per la maggior parte dei supporti è possibile usare un normale adesivo per piastrelle a presa idraulica. La colla deve aderire meccanicamente al sottofondo ed al tessuto della guaina, quindi verificare preventivamente eventuali incompatibilità tra i materiali.
3. Applicare il collante sul sottofondo utilizzando una spatola dentata idonea ( da 3 x 3 mm o 4 x 4 mm ).
4. Tagliare a misura i teli di Arcansas LAY necessari al progetto ed applicarli sullo strato di colla precedentemente steso. Premere la guaina con il lato liscio della spatola dentata in direzione obliqua rispetto alla guaina stessa, esercitando una certa pressione, in modo tale da evitare la formazione di bolle d'aria.
5. Nei punti di giunzione, i teli della guaina Arcansas LAY devono necessariamente essere sovrapposti per almeno 5 cm.
6. Dopo aver realizzato una perfetta impermeabilizzazione e dopo avere effettuato i dovuti sormonti in prossimità di angoli e raccordi, si può procedere con la posa del rivestimento. Non è necessario attendere la presa del collante utilizzato per la posa della guaina.
7. Per la posa del rivestimento applicare il collante a presa idraulica direttamente sulla guaina Arcansas LAY, posando le piastrelle possibilmente a letto pieno. Nel caso di rivestimenti sensibili a particolari agenti chimici è necessario utilizzare collanti e prodotti per fughe adatti.

## INSTALLATION INSTRUCTIONS

1. The laying surface must be smooth and free of any residues that could adversely affect the adhesion. If necessary, level the surface before laying Arcansas LAY.
2. The adhesive used to fix the Arcansas LAY mat to the support must be suitable for the type of support itself. As a rule, for most of the supports, it is possible to use a normal glue for tiles with hydraulic grip. The glue must adhere mechanically to the substrate and to the fabric of the mat, consequently check beforehand for any incompatibilities between materials.
3. Apply the glue to the substrate using a suitable notched trowel ( of 3 x 3 mm or 4 x 4 mm ).
4. Cut to size the Arcansas LAY mats needed for the project and apply them to the previously laid layer of glue. Press the mat to the glue, using the smooth side of the notched trowel in an oblique direction respect to the mat, so as to avoid air bubbles.
5. At the junction points, the Arcansas LAY mats must absolutely be overlaid of at least 5 cm.
6. Once having made a perfect waterproofing and after having done the necessary overlaps at the corners and joints, you can proceed with the laying of the covering. It is not necessary to wait for the glue to grip for the installation of the mat.
7. For the laying of the covering apply the hydraulic grip glue directly on the Arcansas LAY mat, laying the tiles with plenty of glue. In the case of coverings sensitive to particular chemical agents, it is necessary to use suitable adhesives and products for the joints.

Arcansas LAY è una guaina impermeabilizzante in polietilene morbido, rivestita su entrambi i lati di una speciale tessutona-tessuto feltrato che ne garantisce la presa con il collante. Si tratta di un sistema d'impermeabilizzazione da installare direttamente sotto al pavimento o rivestimento in ceramica/ pietra naturale, con stampa centimetrata sulla superficie, in modo da facilitarne il taglio su misura al momento della posa.

Arcansas LAY est une natte d'étanchéité en polyéthylène souple, revêtu sur les deux faces avec un tissu feutré non tissé spécial, qui garantit l'ancrage avec la colle. C'est un système d'imperméabilisation qui se pose directement sous le sol ou revêtement, en céramique/pierre naturelle, avec une impression au centimètre sur la surface pour en faciliter la découpe sur mesure au moment de la pose.

Arcansas LAY is a waterproofing mat in soft polyethylene, covered on both sides with a special non-woven felted fabric which guarantees the grip with the glue. It is a waterproofing system to be installed directly under the ceramic/natural stone flooring or cladding, with a centimetre print on the surface, so as to ease the custom cutting during the installation.

Arcansas LAY es una funda de polietileno impermeable cubierto en ambos lados con un tejido no tejido especial de fieltro, lo que garantiza su agarre con el adhesivo. Es un sistema impermeabilizante para ser instalado directamente debajo del suelo o revestimiento de cerámica/piedra natural, con estampado centimétrico en la superficie, para facilitar el corte a medida a la hora de la colocación.



## MISE EN OEUVRE

1. La surface de pose doit être lisse et sans aspérité pour ne pas compromettre l'adhérence. Au besoin, niveler la surface avant de poser Arcansas LAY.
2. La colle avec laquelle fixer la natte Arcansas LAY au support doit être adéquate au type du support. En général, dans la plupart des supports, il est possible d'utiliser une normale colle à prise hydraulique pour carreau. La colle doit adhérer mécaniquement au fond et au tissu de la natte, il faut donc vérifier à priori d'éventuelles incompatibilités entre les matériaux.
3. Appliquer la colle sur le fond en utilisant une truelle dentelée (de 3 x 3 mm ou 4 x 4 mm).
4. Découper sur mesure les nattes Arcansas LAY nécessaires pour le projet et appliquer-les sur la couche de colle précédemment étendue. Faire pression sur la natte avec le côté lisse de la truelle dentelée, dans la direction oblique par rapport à la natte, pour éviter la formation des bulles d'air.
5. Aux points de jonction, les nattes Arcansas LAY doivent nécessairement se chevaucher d'au moins 5 cm.
6. Après avoir réalisé une étanchéité parfaite et après avoir fait les recouvrements nécessaires en proximité des angles et des raccords, vous pouvez procéder à la pose du revêtement. Il n'est pas nécessaire d'attendre l'adhérence de la colle pour la pose de la natte.
7. Pour la pose du revêtement, appliquer la colle à prise hydraulique directement sur la natte Arcansas LAY, posant les carreaux avec abondance de colle. Dans le cas de revêtements sensibles à des agents chimiques particuliers, il est nécessaire d'utiliser des colles et produits pour des joints appropriés.

## MÉTODO DE COLOCACIÓN

1. La superficie de aplicación debe ser lisa y libre de residuos, lo que podría comprometer su adhesión. Si necesario, nivelar la superficie antes de la colocación de ARCANSAS LAY.
2. El pegamento con el que se fija la funda ARCANSAS LAY al soporte debe ser apropiado al tipo de soporte en sí. Normalmente para la mayoría de los soportes se pueden utilizar con un adhesivo normal para azulejos con agarre hidráulico. El pegamento debe adherirse mecánicamente al sustrato y al tejido de la funda, por eso hay que verificar de antemano si hay alguna incompatibilidad entre los materiales.
3. Aplicar el pegamento al sustrato con una espátula dentada adecuada (de 3 x 3 mm o 4 x 4 mm).
4. Cortar a medida las hojas de ARCANSAS LAY necesarias para el proyecto y aplicarlas a la capa de pegamento previamente aplicada. Presionar la funda con el lado liso de la espátula dentada en la dirección oblicua a la funda misma, ejercitando cierta presión, para evitar la formación de burbujas de aire.
5. En los puntos de unión, las hojas de la funda ARCANSAS LAY deben ser necesariamente sobrepuestas por lo menos hasta 5 cm.
6. Después de realizar una perfecta impermeabilización y después de hacer las sobreposiciones necesarias cerca de las esquinas y conexiones, se puede proceder a la colocación del revestimiento. No es necesario esperar el agarre del pegamento utilizado para la colocación de la funda.
7. Para la colocación del revestimiento, aplicar el pegamento directamente sobre la funda ARCANSAS LAY, colocando los azulejos posiblemente en llenado. En el caso de recubrimientos sensibles a agentes químicos particulares es necesario usar adhesivos y productos para uniones adecuadas.

## Arcansas MAT / MEMBRANA DESOLIDARIZZANTE

	Cod.	EAN	Descrizione	Min. ord.	€/pz
					



# Arcansas<sup>®</sup> MAT

## MODALITÀ DI POSA

1. La superficie di applicazione deve essere liscia e priva di residui che possano comprometterne l'adesione. Se necessario, livellare la superficie prima di posare Arcansas MAT.
2. Il collante con il quale fissare il tappeto Arcansas MAT al supporto deve essere adeguato al tipo di supporto stesso. Per la maggior parte dei sottofondi è possibile utilizzare un adesivo a letto sottile ed a presa idraulica. È preferibile impastare la colla per incollaggio della guaina al sottofondo con elevata fluidità, rispettando i limiti indicati dal produttore del collante. La colla deve aderire meccanicamente al sottofondo ed al tappeto, quindi verificare preventivamente eventuali incompatibilità tra i materiali.
3. Applicare il collante sul sottofondo utilizzando una spatola dentata idonea.
4. Tagliare a misura i rotoli di Arcansas MAT necessari al progetto ed applicarli sullo strato di colla precedentemente steso. Premere la guaina sul collante utilizzando un frattazzo, facendo attenzione ad applicare il tappeto ben teso, esercitando una leggera trazione. Affiancare quindi tutti i rotoli necessari a ricoprire la superficie della pavimentazione.
5. Per evitare che il tappeto posato si danneggi o si distacchi dal sottofondo, si consiglia di proteggerlo da eccessive sollecitazioni meccaniche, posando assi di camminamento in corrispondenza dei punti di trasporto materiali. Evitare inoltre l'esposizione diretta ai raggi solari o alle intemperie. Rimuovere eventuali ristagni d'acqua dalle cavità quadrate prima di applicare l'adesivo.
6. È possibile posare la pavimentazione subito dopo l'applicazione di Arcansas Mat semplicemente stendendo uno strato di colla adeguata al tipo di pavimentazione. Rasare le cavità quadrate della guaina con la parte liscia della spatola e quindi stendere subito il collante con la parte dentata, possibilmente in un unico procedimento. Si raccomanda di realizzare una posa a letto pieno ed utilizzare una spatola dentata con denti idonei al formato delle piastrelle.
7. In caso di estese superfici di posa del tappeto Arcansas MAT è necessario suddividere la pavimentazione con giunti di dilatazione.

## INSTALLATION INSTRUCTIONS

1. The receiving surface must be smooth and free of any residues that could adversely affect the adhesion. If necessary, level the surface before laying Arcansas MAT.
2. The glue used to fix the Arcansas MAT rug to the support must be suitable for the type of support itself. For most of the substrates, it is possible to use a thin layer of glue with hydraulic grip. It is preferable to mix the glue with a high fluidity, respecting the limits given by the glue producer, for the gluing of the mat to the substrate. The glue must adhere mechanically to the substrate and to the mat, consequently check beforehand eventual incompatibility between the materials.
3. Apply the glue to the substrate using an appropriate notched trowel.
4. Custom cut the rolls of Arcansas MAT needed for the project and lay them on the layer of glue previously laid. Press the mat to the glue using a trowel, paying attention to lay the mat well stretched, exerting a slight pull. Then place all the necessary rolls to cover the surface of the flooring.
5. To prevent that the installed mat from getting damaged or detached from the substrate, we suggest to protect it from excessive mechanical stress, to place walkway boards on the track for material transport. Furthermore, avoid the exposure to direct sunlight or bad weather. Remove eventual stagnant water from the square cavities before applying the glue.
6. It is possible to lay the flooring immediately after the application of the Arcansas Mat simply by spreading a layer of glue, adequate to the type of flooring. Smoothen the square cavities of the mat with the smooth part of the spatula and consequently immediately spread the glue with the notched part, possibly in a unique process. We recommend to make a full bed gluing installation and to use the notched trowel with appropriate notches according to the tile format.
7. In case of wide installation surfaces of the Arcansas MAT, it is necessary to divide the flooring with expansion joints.

Arcansas MAT è un tappeto in polietilene con cavità quadrate su un lato e tessuto in fibra sul retro. Esso permette la posa di pavimentazioni ceramiche o in pietra naturale anche in caso di sottofondi problematici, neutralizzando la trasmissione delle tensioni dal sottofondo al pavimento.

Arcansas MAT est une natte en polyéthylène avec des cavités carrées sur une face et un tissu en fibre sur l'autre. Celle-ci permet la pose de sols en céramique ou en pierre naturelle même dans les cas de fonds problématiques, neutralisant la transmission des tensions du support au sol.

Arcansas MAT is a polyethylene mat with square cavities on one side and fibre fabric on the back. It allows the installation of ceramic or natural stone floorings also in case of problematic substrates, neutralizing the stresses transmission from the substrate to the floor.

Arcansas MAT es una lámina de polietileno con cavidades cuadradas en un lado y tejido de fibra en la parte de atrás. Esto permite la colocación de suelos cerámicos o de piedra natural incluso en el caso de cimientos problemáticos, neutralizando la transmisión de tensiones desde el sustrato al suelo.



## MISE EN OEUVRE

1. La surface de pose doit être lisse et sans aspérité pour ne pas compromettre l'adhérence. Au besoin, niveler la surface avant de poser Arcansas MAT.
2. La colle avec laquelle fixer la natte Arcansas MAT au support, doit être adéquate au type de support. Pour la plupart des supports, il est possible d'utiliser une colle de mince application et à prise hydraulique. Il est préférable de mélanger la colle, pour la fixation de la natte au support, avec une grande fluidité, tout en respectant les limites indiquées par le producteur de la colle. La colle doit adhérer mécaniquement au support et à la natte, il faut donc vérifier à priori d'éventuelles incompatibilités entre les matériaux.
3. Appliquer la colle sur le support en utilisant une truelle dentelée appropriée.
4. Découper sur mesure les rouleaux de nattes Arcansas MAT nécessaires pour le projet et appliquer-les sur la couche de colle précédemment étendue. Appliquer la natte sur la colle, faisant pression sur celle-ci en utilisant une truelle, de façon que la natte soit bien tendue en exerçant une légère traction. Accoster donc tous les rouleaux nécessaires pour recouvrir la surface du sol.
5. Pour éviter que la natte posée s'endommage ou se détache du support, nous conseillons de la protéger contre les contraintes excessives mécaniques, en plaçant des panneaux de passerelle sur les points de transport des matériaux. En outre, éviter l'exposition directe au soleil ou aux intempéries. Éliminer toute eau stagnante des cavités carrées avant d'appliquer la colle.
6. Il est possible de poser le sol tout de suite après l'application d'Arcansas Mat, en appliquant simplement une couche de colle adéquate au sol. Lisser les cavités carrées de la natte en utilisant la partie lisse de la spatule, en s'assurant que les cavités soient pleines de colle, puis étaler immédiatement la colle adéquate au sol, avec la partie dentelée de la spatule, possiblement en une seule opération. Nous conseillons une pose avec abondance de colle et d'utiliser une truelle dentelée adaptée au format des carreaux.
7. Dans le cas de pose de grande surface de la natte Arcansas MAT, il est nécessaire de diviser la surface avec des joints de fractionnement.

## MÉTODO DE APLICACIÓN

1. La superficie de aplicación debe ser lisa y libre de residuos que puedan comprometer su adherencia. Si es necesario, nivelar la superficie antes de colocar el ARCANSAS MAT.
2. El pegamento con el que se debe fijar la lamina ARCANSAS MAT al soporte debe ser apropiado para el tipo de soporte en sí. Para la mayoría de los sustratos es posible usar un adhesivo de capa fina con un agarre hidráulico. Es preferible mezclar el pegamento para la lamina al sustrato con una alta fluidez, respetando los límites indicados por el fabricante del adhesivo. El pegamento debe adherir mecánicamente al sustrato y a la lamina, por eso hay que verificar de antemano si hay alguna incompatibilidad entre los materiales.
3. Aplicar el pegamento al sustrato con una espátula dentada adecuada.
4. Cortar a medida las laminas de ARCANSAS MAT necesarias para el proyecto y aplicarlas a la capa de pegamento previamente aplicada. Presionar la lamina sobre el pegamento con una frata, teniendo cuidado de colocar la lamina bien estirada, ejerciendo un ligero tirón. Colocar todos los rollos necesarios para cubrir la superficie del piso.
5. Para evitar que la lamina instalada se dañe o se desprenda del sustrato, se recomienda protegerla contra el estrés mecánico excesivo colocando tableros en los puntos de transporte de material. Evite también la exposición directa a la luz solar o al mal tiempo. Retire eventual agua de las cavidades cuadradas antes de aplicar el adhesivo.
6. Es posible colocar el piso inmediatamente después de la aplicación de Arcansas Mat simplemente extendiendo una capa de pegamento adecuada para el tipo de piso. Alisar las cavidades cuadradas de la funda con la parte lisa de la espátula y luego extender inmediatamente el adhesivo con la parte dentada, posiblemente en un solo procedimiento. Se recomienda colocar los azulejos en llenado y usar una espátula dentada con dientes adecuados para el tamaño de los azulejos.
7. En el caso de superficies extendidas de colocación de la lamina ARCANSAS MAT, es necesario dividir el piso con juntas de expansión.



# Profili per Balcone

Balcony profiles/ Profilés pour Balcon/ Perfiles para Balcón

## Profili balcone:

Profilo con bordo di contenimento superiore che rende idonea la posa evitando l'uso di soglie. Protegge e rifinisce i bordi esterni del balcone evitando il contatto diretto dell'acqua piovana con il massetto in cemento. La sua sezione inclinata e con fori di drenaggio consente il defluire dell'acqua e umidità penetrata attraverso le fughe della pavimentazione evitando il sollevamento delle piastrelle.

Sistema composto da 3 elementi (barra profilo perimetrale da 2,7 mt, angolo esterno, giunto di raccordo). Realizzato in alluminio e sottoposto a processo di anodizzazione che garantisce una buona resistenza agli agenti chimici ed atmosferici. Disponibile in diversi colori e in finiture lucide ed effetto pietra.

## Vantaggi:

Funzione di protezione. Assicurano un corretto deflusso delle acque meteoritiche. Evitano le infiltrazioni. Profili resistenti e leggeri.

## Balcony profiles:

Innovative edging profile specifically designed to permit the efficient run-off of water and to replace the old marble edges. It covers the external edges of the balcony and protects the screed from rainwater. Its sloped section and its perforated anchoring flange allow the run-off of the water and humidity seeped through the flooring grout lines, avoiding tiles damages.

Besides the 2,7mt profile, Arcansas supplies also precutted external corners and joints. All components are made from aluminium and are available in several different colours and finishing.

## Advantages:

Protection of the external edges of the balcony. Ensure the efficient run-off of rainwater. Prevent seepages. Light and resistant profiles.

## Profilés pour balcon :

Profilé avec bord de confinement supérieur qui le rend approprié pour l'installation en évitant l'utilisation de seuil. Il protège et termine les bords extérieurs du balcon en évitant le contact direct de l'eau de pluie avec la chape en béton. Sa section inclinée et avec des trous de drainage permet l'écoulement de l'eau et de l'humidité qui pénètrent à travers les joints du plancher en évitant le soulèvement des carreaux.

Système composé de 3 éléments (barre profilée de 2,7 m de périmètre, coin extérieur, joint de raccordement). Fabriqué en aluminium et soumis à un processus d'anodisation qui garantit une bonne résistance aux agents chimiques et atmosphériques. Disponible en différentes couleurs et dans des finitions brillantes et effet pierre.

## Avantages:

Fonction de protection. Ils assurent un bon écoulement des eaux météoriques. Ils évitent les infiltrations. Profilés résistants et légers.

## Perfiles para balcón:



Perfil con borde de contención superior que hace que la instalación sea adecuada evitando el uso de umbrales. Protege y termina los bordes externos del balcón evitando el contacto directo del agua de lluvia con la solera de hormigón. Su sección inclinada y con orificios de drenaje permite que el agua y la humedad penetren a través de las juntas del piso evitando el levantamiento de las baldosas.

Sistema compuesto por 3 elementos (barra de perfil perimetral de 2,7 m, esquina externa, junta de conexión). Fabricado en aluminio y sometido a un proceso de anodización que garantiza una buena resistencia a los agentes químicos y atmosféricos. Disponible en diferentes colores y en acabados brillantes y efecto piedra.

## Ventajas:

Función de protección. Aseguran la salida adecuada de las aguas meteorológicas. Evitan las infiltraciones. Perfiles resistentes y ligeros.



GOCCIOLATOIO ECO	Finitura - Finish	EAN	Cod.	H. (mm)	L. (m)	Conf. Carton	Min. ord.
	argento anodizzato satinato satin anodised silver	8013237136598	430A / L 	20,70 	2,50	1	10

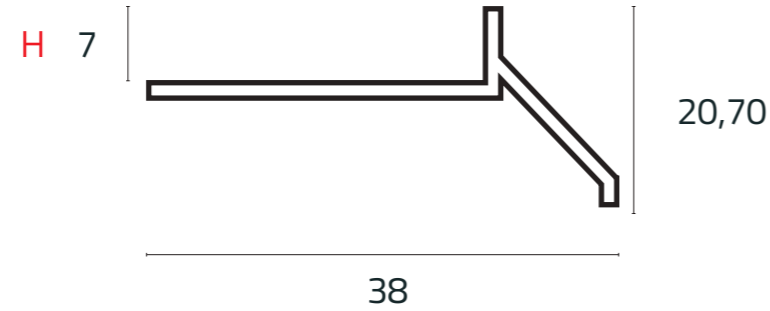

Prima dell'applicazione / Before application



Dopo applicazione / After application





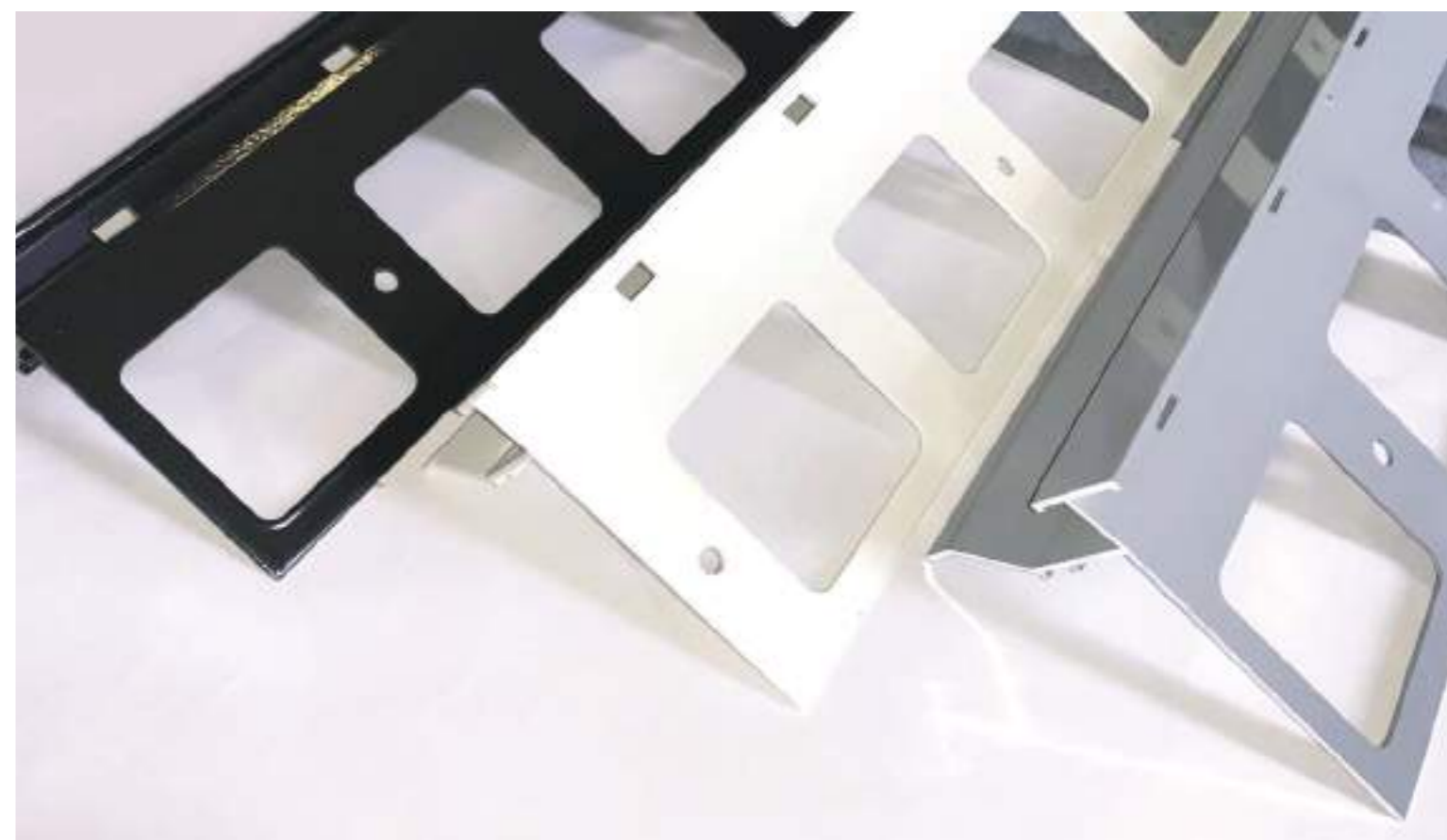
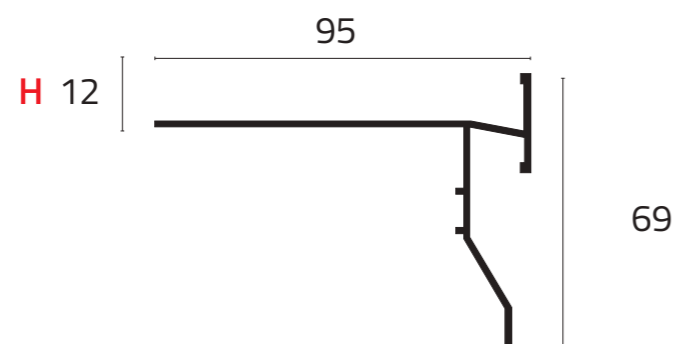

PROFILO PERIMETRALE	Finitura - Finish	EAN	Cod.	H. (mm)	L. (m)	Conf. Carton	Min. ord.	
	alluminio naturale natural aluminium							
	verniciato lucido bianco RAL 9010 polished white RAL 9010	8013237143435	430A/9010	69	2,70	1	5	
	verniciato lucido grigio RAL 7040 polished grey RAL 7040	8013237131692	430A	69		2,70	1	5
	verniciato lucido grigio micaceo RAL 7011 polished micaceo grey RAL 7011	8013237143442	430A/7011	69		2,70	1	5
	verniciato lucido testa di moro RAL 8019 polished brown RAL 8019	8013237140816	430A/8019	69		2,70	1	5





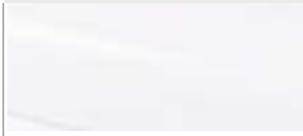



**ANGOLO ESTERNO  
GOCCIOLATOIO**

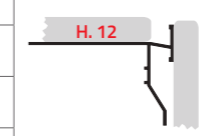

Finitura - Finish		EAN	Cod.	H. (mm)	L. (m)	Conf. Carton	Min. ord.
	verniciato lucido bianco RAL 9010 polished white RAL 9010	8013237143459	430B/9010	69	95	1	5
	verniciato lucido grigio RAL 7040 polished grey RAL 7040	8013237132323	430B 	69	95	1	5
	verniciato lucido grigio micaceo RAL 7011 polished micaceo grey RAL 7011	8013237143466	430B/7011	69	95	1	5
	verniciato lucido testa di moro RAL 8019 polished brown RAL 8019						



Finitura - Finish		EAN	Cod.	H. (mm)	L. (m)	Conf. Carton	Min. ord.
	verniciato lucido bianco RAL 9010 polished white RAL 9010	8013237143497	430D/9010	69	95	1	5
	verniciato lucido grigio RAL 7040 polished grey RAL 7040	8013237143503	430D	69	95	1	5
	verniciato lucido grigio micaceo RAL 7011 polished micaceo grey RAL 7011	8013237143473	430D/7011	69	95	1	5
	verniciato lucido testa di moro RAL 8019 polished brown RAL 8019	8013237143480	430D/8019	69	95	1	5

Problema/ The problem







Soluzione/ The solution

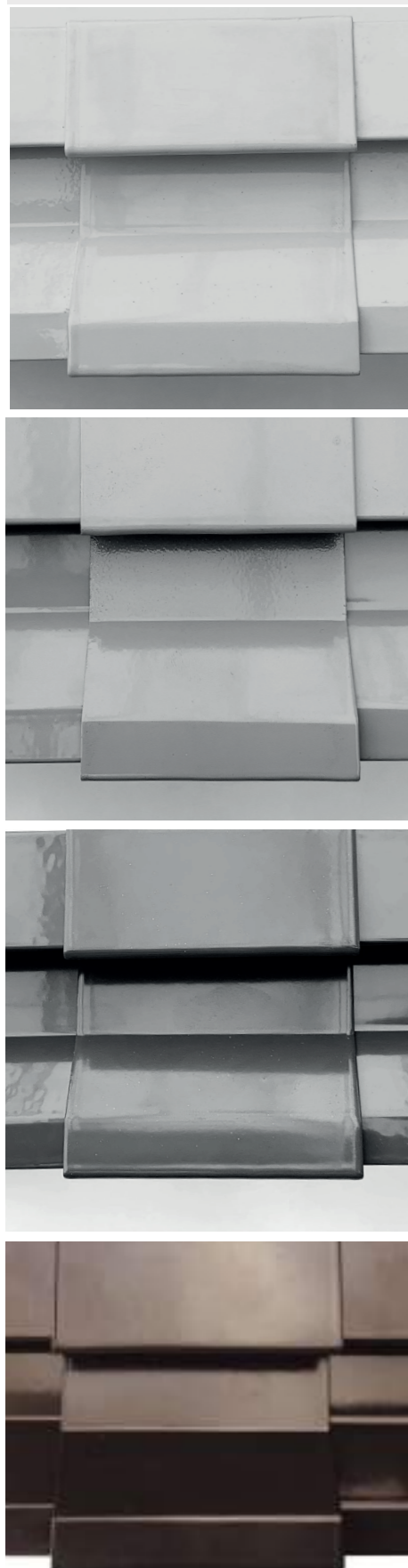

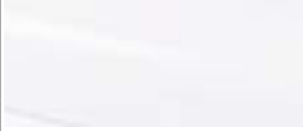







**GIUNTO DI RACCORDO  
GOCCIOLATOIO**

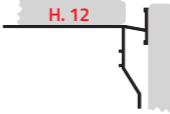

Finitura - Finish		EAN	Cod.	H. (mm)	L. (m)	Conf. Carton	Min. ord.		
	verniciato lucido bianco RAL 9010 polished white RAL 9010	8013237143510	430C/9010	74	2,70	1	5		
	verniciato lucido grigio RAL 7040 polished grey RAL 7040	8013237132330	430C 	74	2,70	1	5		
	verniciato lucido grigio micaceo RAL 7011 polished micaceo grey RAL 7011	8013237143527	430C/7011	74	2,70	1	5		
	verniciato lucido testa di moro RAL 8019 polished brown RAL 8019	8013237141493	430C/8019	74	2,70	1	5		



PROFILO PERIMETRALE	Finitura - Finish	EAN	Cod.	H. (mm)	L. (m)	Conf. Carton	Min. ord.	
	 verniciato effetto pietra beige stone finishing painting beige							
	 verniciato effetto pietra sabbia stone finishing painting sand							
	 verniciato effetto pietra cemento stone finishing painting concrete							
	 verniciato effetto pietra antracite stone finishing painting anthracite							
	 verniciato effetto pietra fumo di Londra stone finishing painting London smoke	8013237144920	430A/104		69	95	1	5
	 verniciato effetto pietra ruggine stone finishing painting rust							

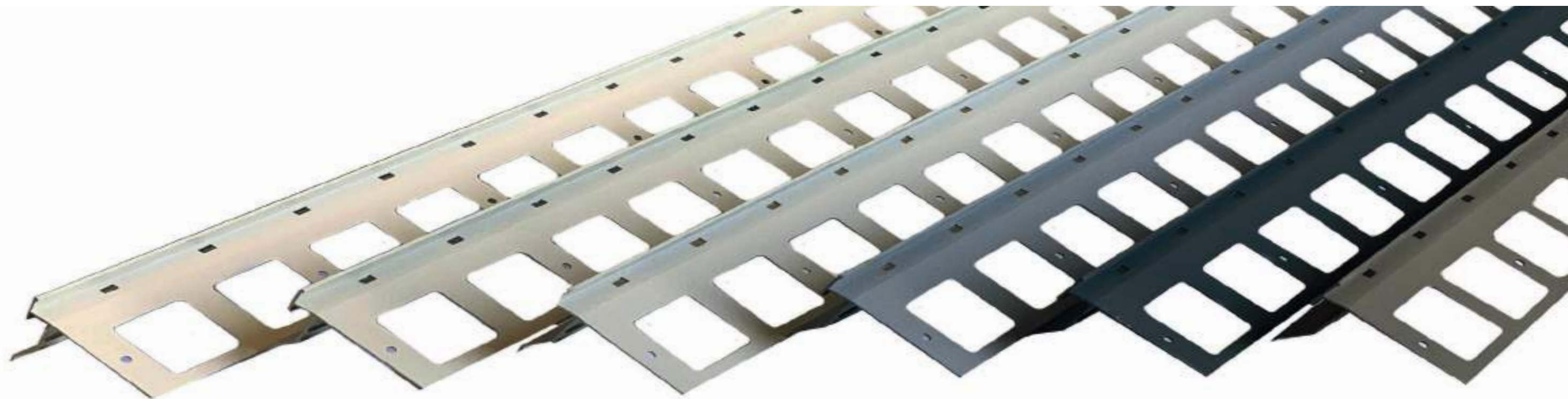

**ANGOLO ESTERNO  
GOCCIOLATOIO**

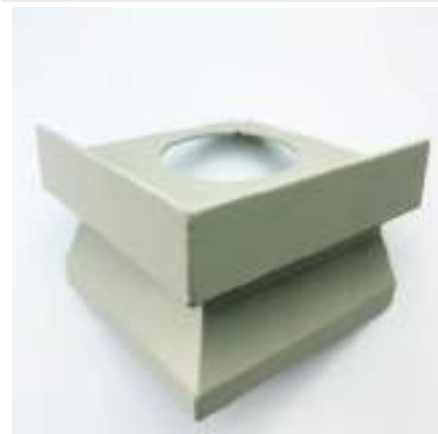

Finitura - Finish		EAN	Cod.	H. (mm)	L. (m)	Conf. Carton	Min. ord.
	verniciato effetto pietra beige stone finishing painting beige						
	verniciato effetto pietra sabbia stone finishing painting sand						
	verniciato effetto pietra cemento stone finishing painting concrete						
	verniciato effetto pietra antracite stone finishing painting anthracite						
	verniciato effetto pietra fumo di londra stone finishing painting london smoke	8013237145590	<b>430B/104</b>	69	95	1	5
	verniciato effetto pietra ruggine stone finishing painting rust						

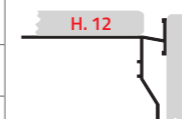



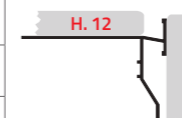

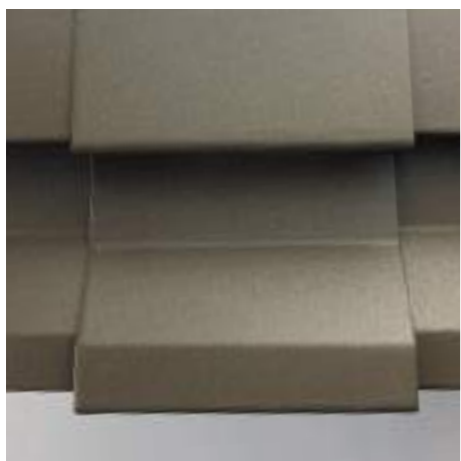
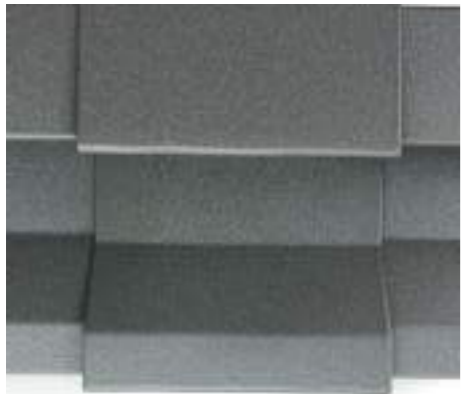
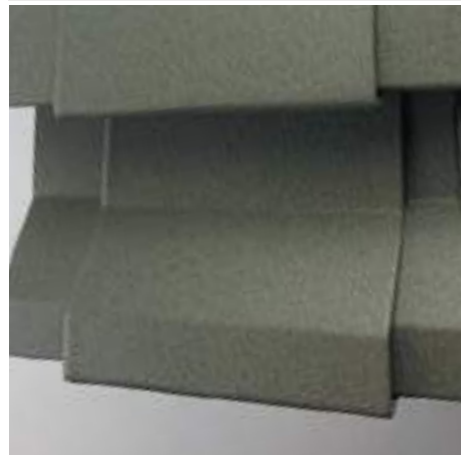

Finitura - Finish		EAN	Cod.	H. (mm)	L. (m)	Conf. Carton	Min. ord.
	verniciato effetto pietra beige stone finishing painting beige	8013237984724	<b>430D/101</b>	69	95	1	5
	verniciato effetto pietra sabbia stone finishing painting sand	8013237985202	<b>430D/102</b>	69	95	1	5
	verniciato effetto pietra cemento stone finishing painting concrete	8013237983482	<b>430D/103</b>	69	95	1	5
	verniciato effetto pietra antracite stone finishing painting anthracite	8013237983505	<b>430D/105</b>	69	95	1	5
	verniciato effetto pietra fumo di londra stone finishing painting london smoke	8013237983499	<b>430D/104</b>	69	95	1	5
	verniciato effetto pietra ruggine stone finishing painting rust	8013237984168	<b>430D/100</b>	69	95	1	5



**GIUNTO DI RACCORDO  
GOCCIOLATOIO**



Finitura - Finish	EAN	Cod.	H. (mm)	L. (m)	Conf. Carton	Min. ord.
 verniciato effetto pietra beige stone finishing painting beige						
 verniciato effetto pietra sabbia stone finishing painting sand						
 verniciato effetto pietra cemento stone finishing painting concrete						
 verniciato effetto pietra antracite stone finishing painting anthracite						
 verniciato effetto pietra fumo di londra stone finishing painting london smoke	8013237145415	<b>430C/104</b>	74	2,70	1	5
 verniciato effetto pietra ruggine stone finishing painting rust						

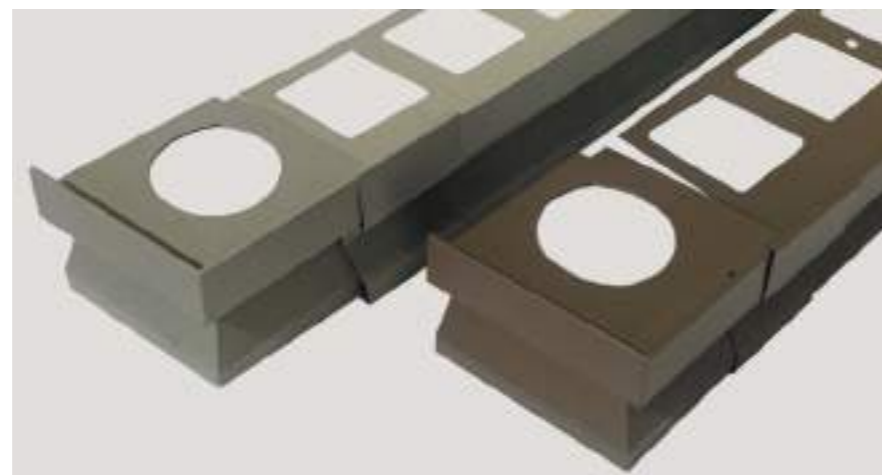

**ANGOLARE PORTAINTONACO IN PVC TIPO GOCCIOLATOIO CON RETE**

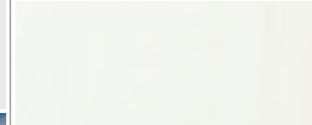
Colore - Colour		Cod.	EAN	Misura(cm)	L. (m)	Conf. Carton	Min. ord.		
	bianco	045L2/01	8013237145781	10x10	2,50	30 pz/cartone - 50 cartoni/bancale 30 pz/box - 50 box/pallet	60 pz		
	white								

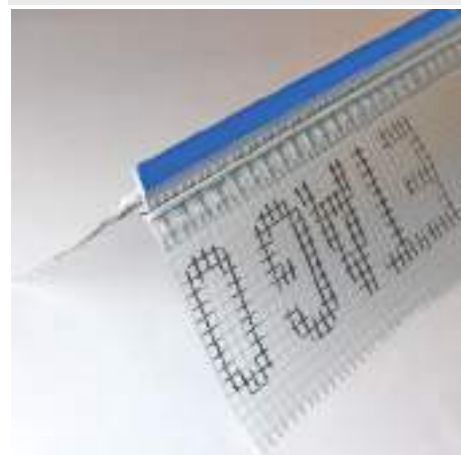

**ANGOLARE PORTAINTONACO IN PVC CON FIBRA DI VETRO 145 g/mq  
CERTIFICATA ETAG 004  
ALETTE E FILM PROTETTIVO  
TIPO "GOCCIOLATOIO"  
LUNGHEZZA 2,5 MT  
PVC CORNER BEAD WITH GLASS FIBRE MESH 145 g/mq  
ETAG 004 CERTIFIED  
EXTENDED ARRIS AND PROTECTIVE FILM  
"DRIPPER" TYPE  
2,5 MT LENGTH**

**ANGOLARE PORTAINTONACO IN PVC CON RETE**

Colore - Colour		Cod.	EAN	Misura (cm)	L. (m)	Conf. Carton	Min. ord.		
	bianco	045L3/01	8013237147051	10x10	2,50	50 pz/cartone - 50 cartoni/bancale 50 pz/box - 50 box/pallet	100 pz		
	white								

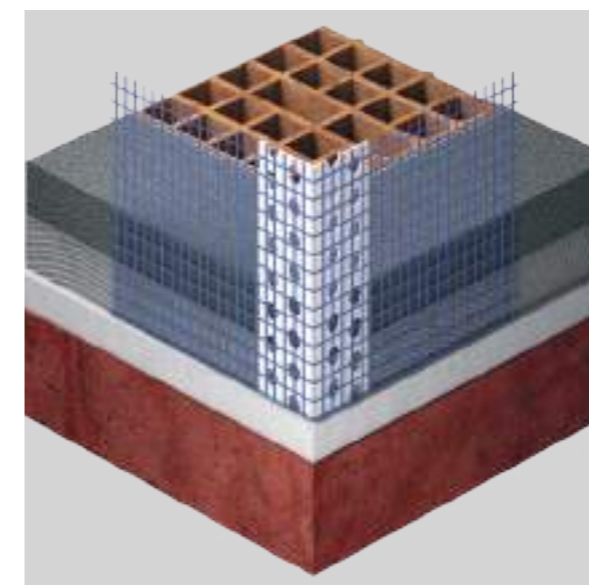
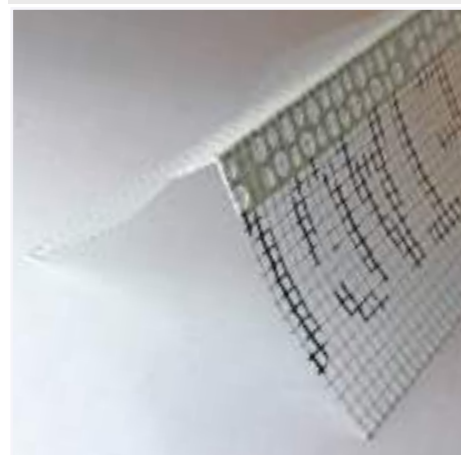

**ANGOLARE PORTAINTONACO IN PVC CON FIBRA DI VETRO 145 g/mq  
CERTIFICATA ETAG 004  
ALETTE E FILM PROTETTIVO  
LUNGHEZZA 2,5 MT  
PVC CORNER BEAD WITH GLASS FIBRE MESH 145 g/mq  
ETAG 004 CERTIFIED  
EXTENDED ARRIS AND PROTECTIVE FILM  
2,5 MT LENGTH**



# Accessori per la posa

Accessories for fixing and laying/ Accessoires de pose/  
Accesorios para la puesta en obra

#### Accessori per la posa:

La gamma di attrezzature e accessori per la posa Arcansas è stata pensata e progettata esclusivamente per i posatori di piastrelle in ceramica, offrendo soluzioni a qualsiasi tipo di lavoro.

Questa gamma comprende tutti i prodotti indirizzati ai professionisti dell'edilizia, in particolare ai professionisti della posa di ceramiche, necessari alle applicazioni di cementi, stucchi, gessi e con lo scopo di ottenere il massimo risultato.

Da sempre Arcansas ha un rapporto costante con i professionisti della posa di ceramiche ed è di vitale importanza continuare questa tradizione di comunicazione. Per questa ragione abbiamo tutte le attrezzature necessarie per offrire ai professionisti del settore prodotti innovativi capaci di dare soluzione alle molteplici esigenze del lavoro quotidiano.

I prodotti della gamma di attrezzature e accessori per la posa Arcansas sono disponibili in svariate versioni, con forme, dimensioni e materiali differenti.

#### Accessories for fixing and laying:

Arcansas range of accessories and devices for fixing and laying has been specifically formulated and designed to satisfy all kind of needs of sector professionals. This range includes all kind of products dedicated to professionals of building industry, in particular to professionals of tiles fixing and laying.

Arcansas has always had a constant relationship with tiles fixing and laying professionals and strongly believe in that relationship. This is why we always offer to sector professionals innovative solutions for the different daily needs.

All the products included in the range of Arcansas fixing and laying accessories are available in several model with different shape, dimension and material.

#### Accessoires de pose :

La gamme des outils et accessoires de pose Arcansas a été conçue exclusivement pour les poseurs de carrelage, elle offre des solutions pour tout type de travail.

Cette gamme comprend tous les produits destinés aux professionnels de la construction, en particulier aux professionnels de la pose du carrelage, nécessaires à l'application du ciment, du stuc, du plâtre et dans le but d'obtenir des résultats optimaux.

L'Arcansas a toujours entretenu une relation constante avec les professionnels de la pose de carreaux de céramique et il est d'une importance vitale de poursuivre cette tradition de communication.

Pour cette raison, nous avons tout l'équipement nécessaire pour offrir aux professionnels du secteur des produits innovants capables de donner des solutions aux multiples besoins du travail quotidien.

Les produits de la gamme outils et accessoires pour la pose d'Arcansas sont disponibles en différentes versions, avec différentes formes, tailles et matériaux.

#### Accesorios para la puesta en obra:

La gama de herramientas y accesorios para la puesta en obra Arcansas fue concebida y diseñada exclusivamente para instaladores de baldosas cerámicas, ofreciendo soluciones para cualquier tipo de trabajo.















Esta gama incluye todos los productos dirigidos a profesionales de la construcción, en particular a profesionales de la instalación de cerámica, necesarios para la aplicación de cemento, estuco, yeso y con el objetivo de obtener los máximos resultados.

Desde siempre Arcansas ha tenido una relación constante con los profesionales de colocación de baldosas cerámicas y es de vital importancia continuar con esta tradición de comunicación. Por este motivo contamos con todo el equipamiento necesario para ofrecer a los profesionales del sector productos innovadores capaces de dar solución a las múltiples necesidades del trabajo diario.

Los productos de la gama de herramienta y accesorios para la puesta en obra de Arcansas están disponibles en varias versiones, con diferentes formas, tamaños y materiales.

**DISTANZIATORI  
PER PIASTRELLE /  
TILE SPACERS /**



	EAN	Cod.	H. (mm)	(mm)	Min. ord.
	8013237060558	135R2 / B 	1	33,00	40 - BS
	8013237024963	135Q1 / B 	2	33,00	40 - BS
	8013237024970	135V1 / B 	3	35,00	40 - BS
	8013237147006	135V2/B	3	29,00	40 - BS
	8013237024932	135N1 / B 	4	32,00	40 - BS
	8013237024741	135U1 / B 	5	32,00	40 - BS
	8013237024987	135A1 / B 	10	49,00	40 - BS
	8013237060633	135R3 / B 	1	23,00	40 - BS
	8013237025038	135R1 / B 	2	23,00	40 - BS
	8013237024949	135P1 / B 	3	32,00	40 - BS
	8013237025021	135M1 / B 	4	32,00	40 - BS
	8013237024956	135L1 / B 	5	32,00	40 - BS
	8013237024994	135B1 / B	10	49,00	40 - BS
	8013237025045	135S1 / B 	5	2,00	40 - BS









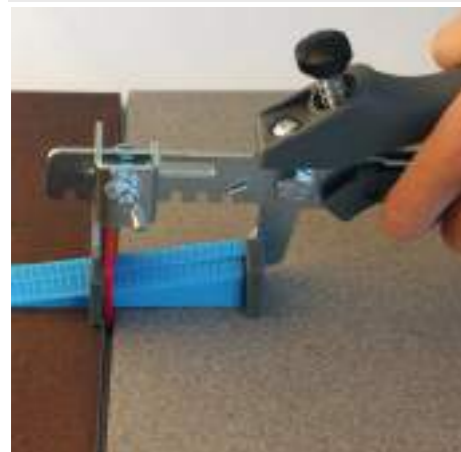









**CUNEO /  
WEDGE /**





**DISTANZIATORI  
LIVELLANTI  
Cuneo / Tirante  
LEVELLING CLIPS  
Wedge / Clip**



	Descrizione - Description	EAN	Cod.	Min. ord
	distanziatore da 1 mm tirante per spessore 0/12 (250 pezzi / busta) 1 mm joint for clip 0-12 mm thickness (250 pcs / bag)	8013237139971	<b>135AC / 01</b> 	12 buste / scatola 60 x 40 x 35 10,30 kg 12 bags / box 60 x 40 x 35 10,30 kg
	distanziatore da 2 mm tirante per spessore 0/12 (250 pezzi / busta) 2 mm joint for clip 0-12 mm thickness (250 pcs / bag)	8013237139988	<b>135AC / 02</b> 	12 buste / scatola 60 x 40 x 35 10,30 kg 12 bags / box 60 x 40 x 35 10,30 kg
	distanziatore da 3 mm tirante per spessore 0/12 (250 pezzi / busta) 3 mm joint for clip 0-12 mm thickness (250 pcs / bag)	8013237139995	<b>135AC / 03</b> 	12 buste / scatola 60 x 40 x 35 10,30 kg 12 bags / box 60 x 40 x 35 10,30 kg
	distanziatore da 2 mm tirante per spessore 13/20 (250 pezzi/busta) 2 mm joint for clip 13-20 mm thickness (250 pcs / bag)	8013237140007	<b>135AC / 04</b> 	12 buste / scatola 60 x 40 x 35 10,30 kg 12 bags / box 60 x 40 x 35 10,30 kg
	cuneo (100 pezzi/busta) wedge (100 pcs / bag)	8013237140014	<b>135AC / 05</b> 	20 buste / scatola 60 x 40 x 44 19 kg 20 bags / box 60 x 40 x 44 19 kg
	pinza professionale (1pz/blister) professional plier (1pc / blister)	8013237140021	<b>135AC / 08</b> 	1 pz / scatola 1 pcs / box
	distanziatore da 1 mm tirante per spessore 0/12 (250 pezzi / busta) 1 mm joint for clip 0-12 mm thickness (250 pcs / bag)	8013237147020	<b>135AC2 / 01</b>	12 buste / scatola 60 x 40 x 35 10,30 kg 12 bags / box 60 x 40 x 35 10,30 kg
	distanziatore da 1,5 mm tirante per spessore 0/12 (250 pezzi / busta) 1,5 mm joint for clip 0-12 mm thickness (250 pcs / bag)	8013237146979	<b>135AC / 06</b>	12 buste / scatola 60 x 40 x 35 10,30 kg 12 bags / box 60 x 40 x 35 10,30 kg
	distanziatore da 2 mm tirante per spessore 0/12 (250 pezzi / busta) 2 mm joint for clip 0-12 mm thickness (250 pcs / bag)	8013237147037	<b>135AC2 / 02</b>	12 buste / scatola 60 x 40 x 35 10,30 kg 12 bags / box 60 x 40 x 35 10,30 kg
	distanziatore da 2,5 mm tirante per spessore 0/12 (250 pezzi / busta) 2,5 mm joint for clip 0-12 mm thickness (250 pcs / bag)	8013237146986	<b>135AC / 09</b>	12 buste / scatola 60 x 40 x 35 10,30 kg 12 bags / box 60 x 40 x 35 10,30 kg
	cuneo (100 pezzi/busta) wedge (100 pcs / bag)	8013237147044	<b>135AC2 / 05</b>	20 buste / scatola 60 x 40 x 44 19 kg 20 bags / box 60 x 40 x 44 19 kg
	pinza professionale in PVC (1pz/blister) PVC professional plier (1pc / blister)			

**DISTANZIATORI  
LIVELLANTI**  
Cappuccio  
autoavvitante / Tirante  
**LEVELLING CLIPS**  
Self-screwing cap / Clip



	Descrizione - Description	EAN	Cod.	Min. ord.	€/BS
					
					
					
					



KIT MAGNETICO	Materiale e finitura - Material and finish	EAN	Cod.	H (mm)	Conf. Carton	Min. ord.
 <p>MACH 4 x 4 FLIESEN MAGNETE</p>	<p>acciaio steel</p>	<p>8013237139155</p>	<p>397/KIT </p>	<p>1</p>	<p>4</p>	<p>10</p>

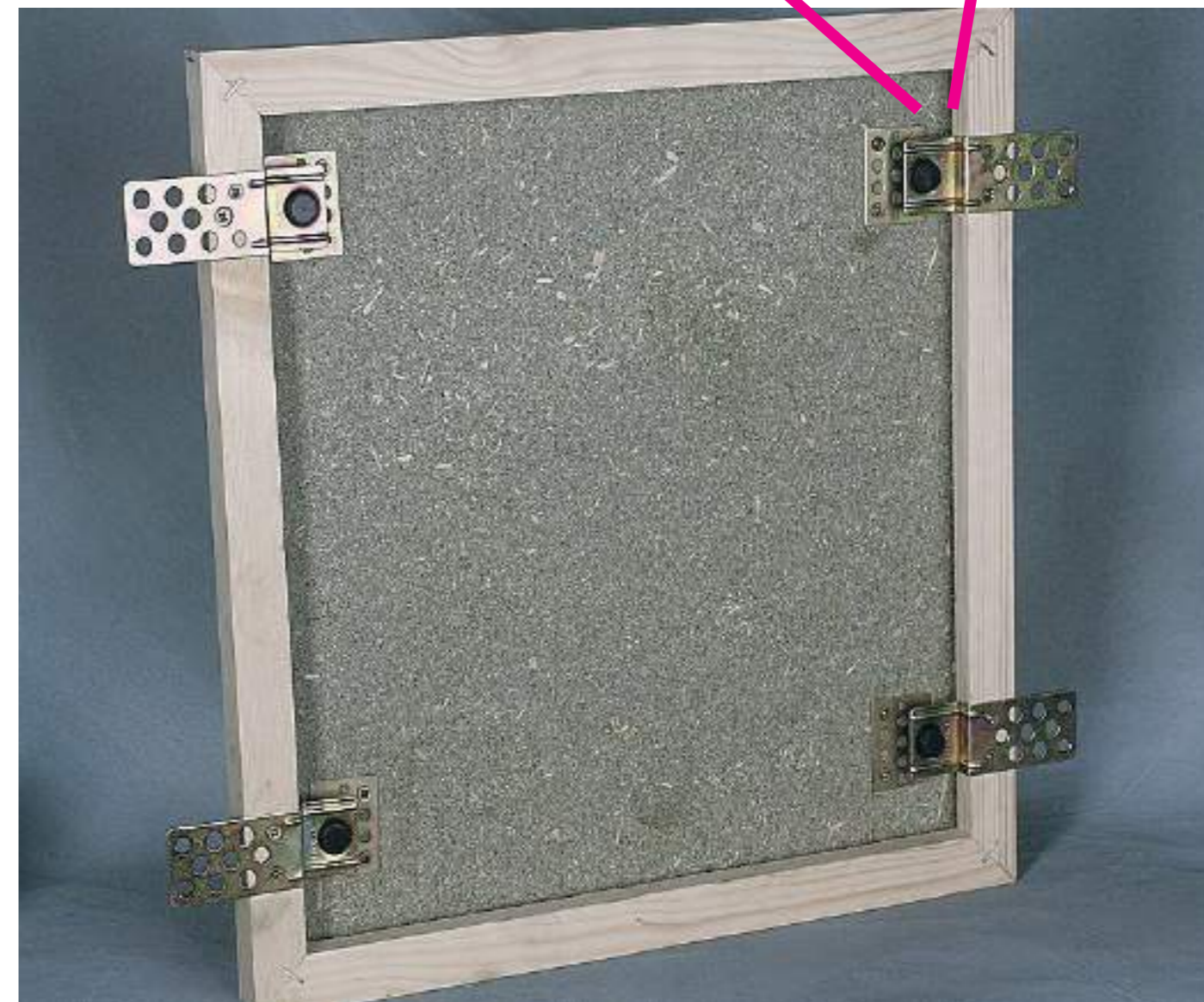
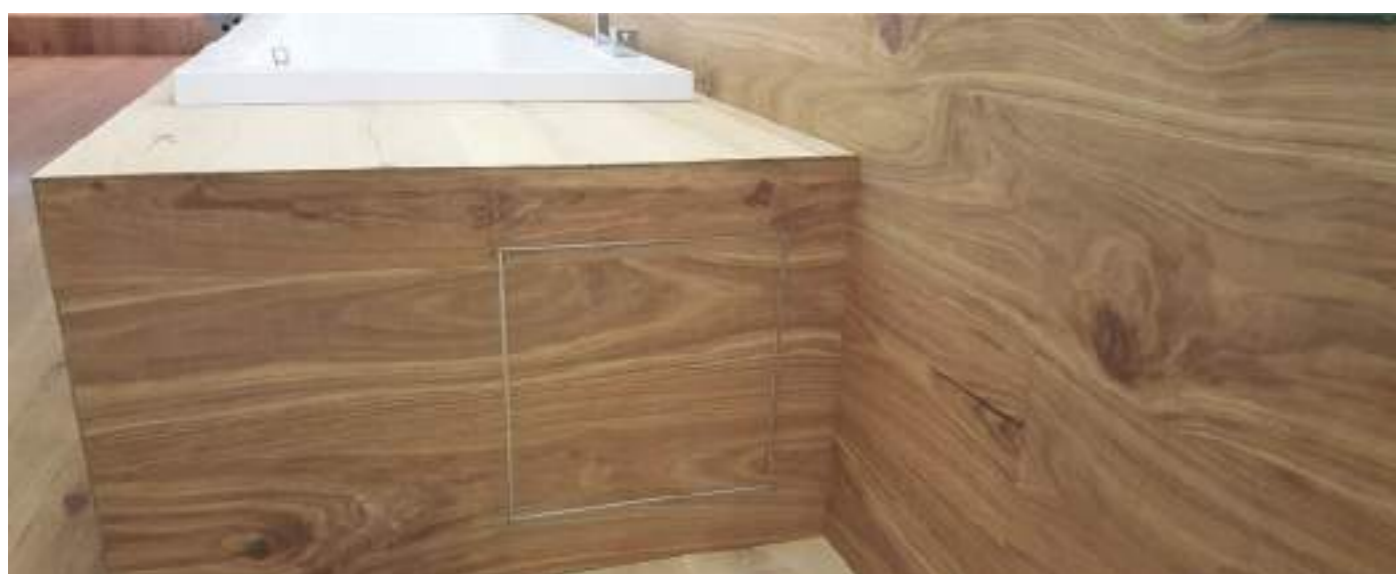

products / **product**

the character is recognized by its profile

**4** BUSINESS AREAS

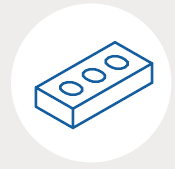

building dealers  
revendeurs bâtiment  
revendedores de materiales  
de construcción



hardware  
quincaillerie  
ferretería



ceramic dealers  
revendeurs carrelage  
revendedores de cerámicas



large retail chains  
GDO  
GDO

The profiles are not simple metal rods for us, but a starting point of a **tailor-made project for each customer**, that we accompany passionately along the full sales process. Placed in our **display systems** they become the do-it-yourself winning solution.

We offer profiles in most different materials and finishings, to ensure that the customer chooses the most suitable for his needs. From ceramics to sanitary, floor and do-it-yourself. A **wide choice of colours** is repeated in all the collections to offer **depth and range synergy**.

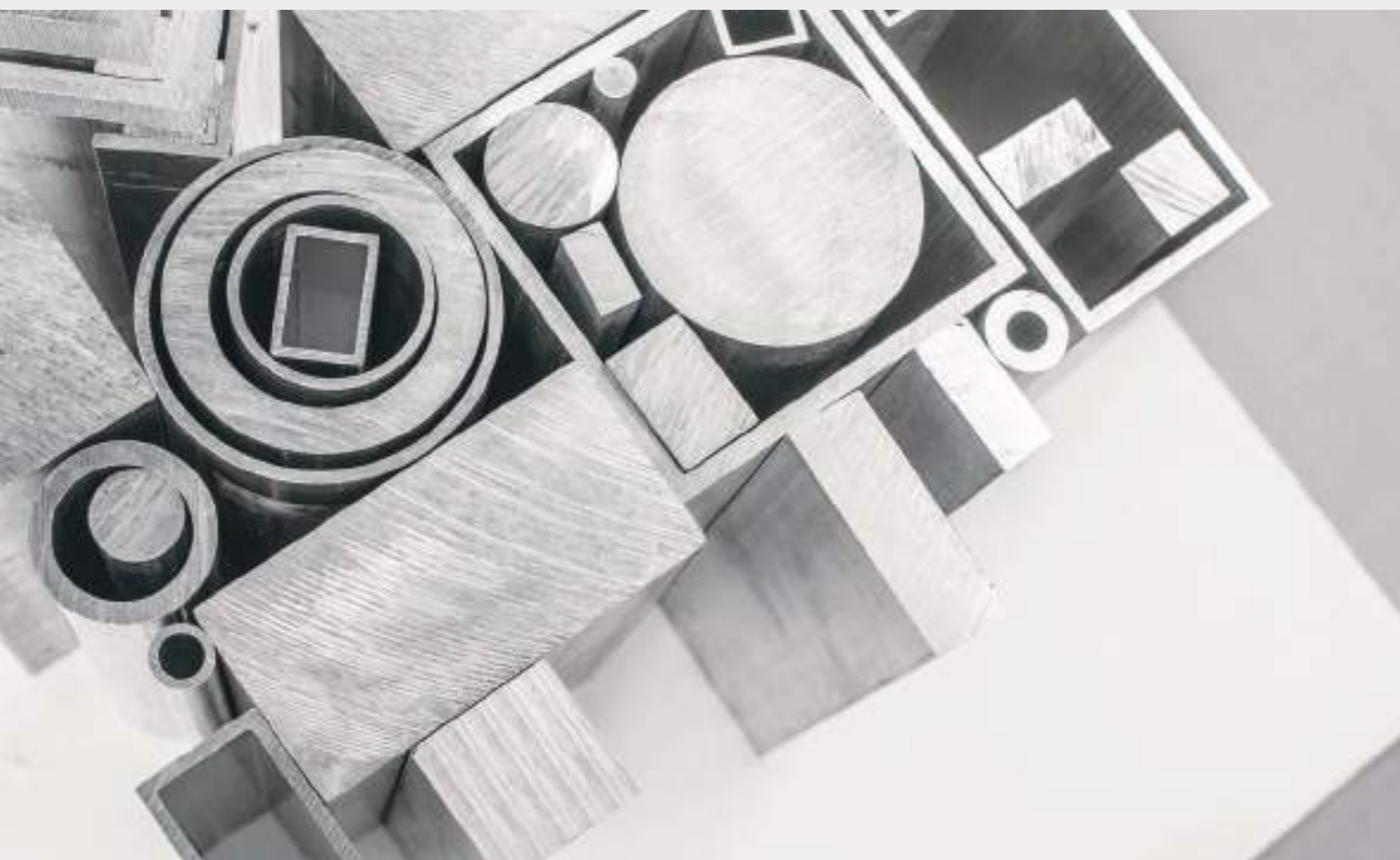

**Profiles for tiling**

For this product range ask for other Arcansas catalogues

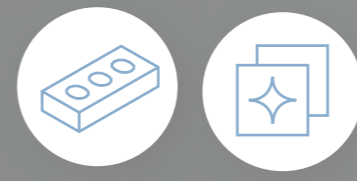

**Hygienic cove profiles**

For this product range ask for other Arcansas catalogues



**Flooring profiles**

For this product range ask for other Arcansas catalogues



**Profiles for hardware/diy**



### Profiles for tiling



-  **Facilitate** the installation and increase life time of the tile
-  **Hide** the rough outer edge of the tile
-  **Make safe and finish** the external edges of columns, niches and shelves
-  Ideal for **wall and floor**
-  Available in **stainless steel, aluminum** and **PVC** to meet the needs of any project



### Flooring profiles

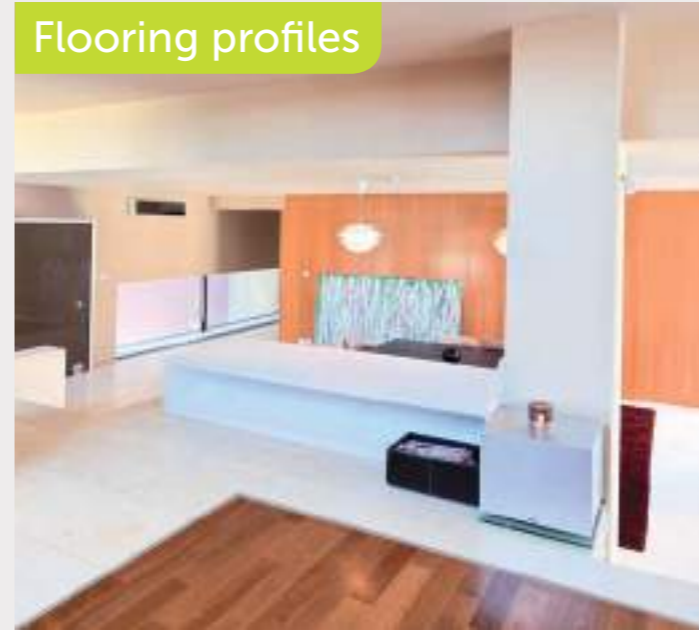





-  **They join and harmonize** coplanar floors or with level differences
-  **Non-slip knurled surface**
-  Adhesive fixing for a **do-it-yourself, quick and simple installation**
-  **Fixing with rails** suitable for wooden floors
-  **Safe fixing** for high stability in civil and high traffic environments
-  **Fixing screws included** of the same colour of the matched profile



### Hygienic cove profiles







-  **Prevent water and mold from infiltrating** through the wall edge of the shower, tub and sink
-  **Conceal the sealant** that deteriorates over time
-  Concave shape **prevents the deposit of dirt and bacteria**, facilitating the cleaning
-  **White gloss finish** with a **porcelain effect** that does not yellow
-  **Immediate application** in the self-adhesive version



### Profiles for hardware/diy



-  **Lightweight, handy** to transport
-  **Variety of cross-sections** for do-it-yourself projects
-  **Easy to drill, cut, weld and paint**
-  Exclusive colour ranges: **we are the only one to offer glossy finish PVC and mat black aluminium**
-  **Color fixed by anodic bath** that does not deteriorate



market  
identity target  
advertising marketing  
expectation product  
success name symbol quality  
label value trademark  
loyalty local business  
image impression focus

brand

unique image  
corporate orientation  
design registration  
sign consumer  
trend media  
management logo  
distribution

Marketing su misura  
Customized marketing  
Marketing sur-mesure  
Marketing personalizado

clients / **project**  
the character is recognized by its profile



**34**

countries with partner distributors

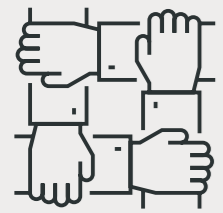

**110**

agents for the sales network (Italian and foreign market)



**AN INTERNATIONAL NETWORK**

**Not only Italy:** we are present on the international market with distribution centers in South America, France and Belgium. By means of a capillary network of agents and merchandisers we constantly support each of our customer, anywhere in the world.

To choose us means to start a path of shared growth. We **work together** with our customers to understand which products and display units suit best to their business and the most effective approach to get the **best performance on the market together with high profitability.**

We care and want to solve the multiple needs of our customers. Each one represents a unique and exclusive reality. We dedicate them our constant attention and care for the details. We support them with passion and continuity, establishing one **real partnership to guarantee medium and long-term results.**



I design every day functional solutions targeted for each customer. My sales manual? **listen** and relate myself with each one of them, to **understand specific needs and targets.**

Lorenzo Tinti, marketing department

● **Arcansas locations Italy / Europe**

**ITALY (Piagge)** | headquarters (production, stock, logistics)

**ITALY (Mondavio)** | branch 1 (production )

**FRANCE (Diemoz)** | warehouse and sales office 1

**SPAIN (Barcelona)** | sales office 2

**GERMANY (Dresden)** | sales office 3

**UNITED KINGDOM (Bedford)** | sales office 4

**POLAND (Wroclaw)** | sales office 5

● **Arcansas agents in Europe and worldwide**

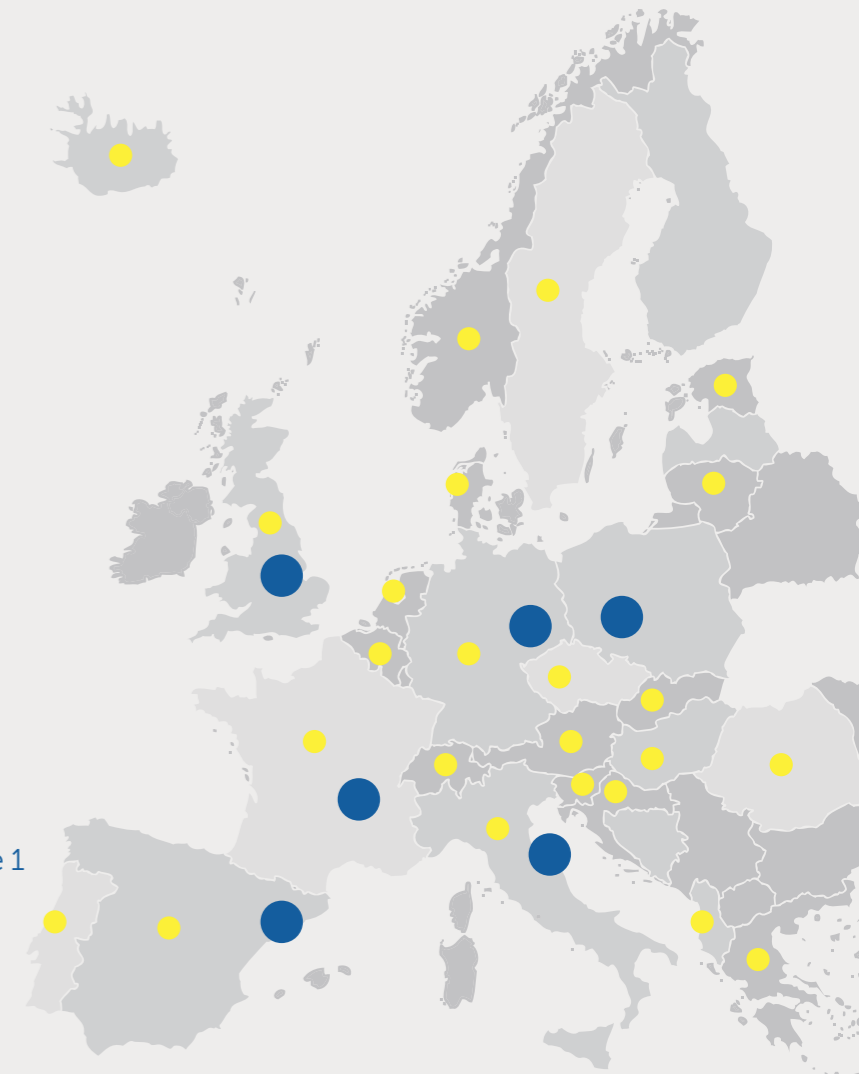

We organise **training courses for sales people and sector heads**, in co-operation with important partners in the large retail chains. The courses develop

skills and professionalism on the use of the product, on fitting systems and application sectors, in order to **propose to the customer the best solution.**

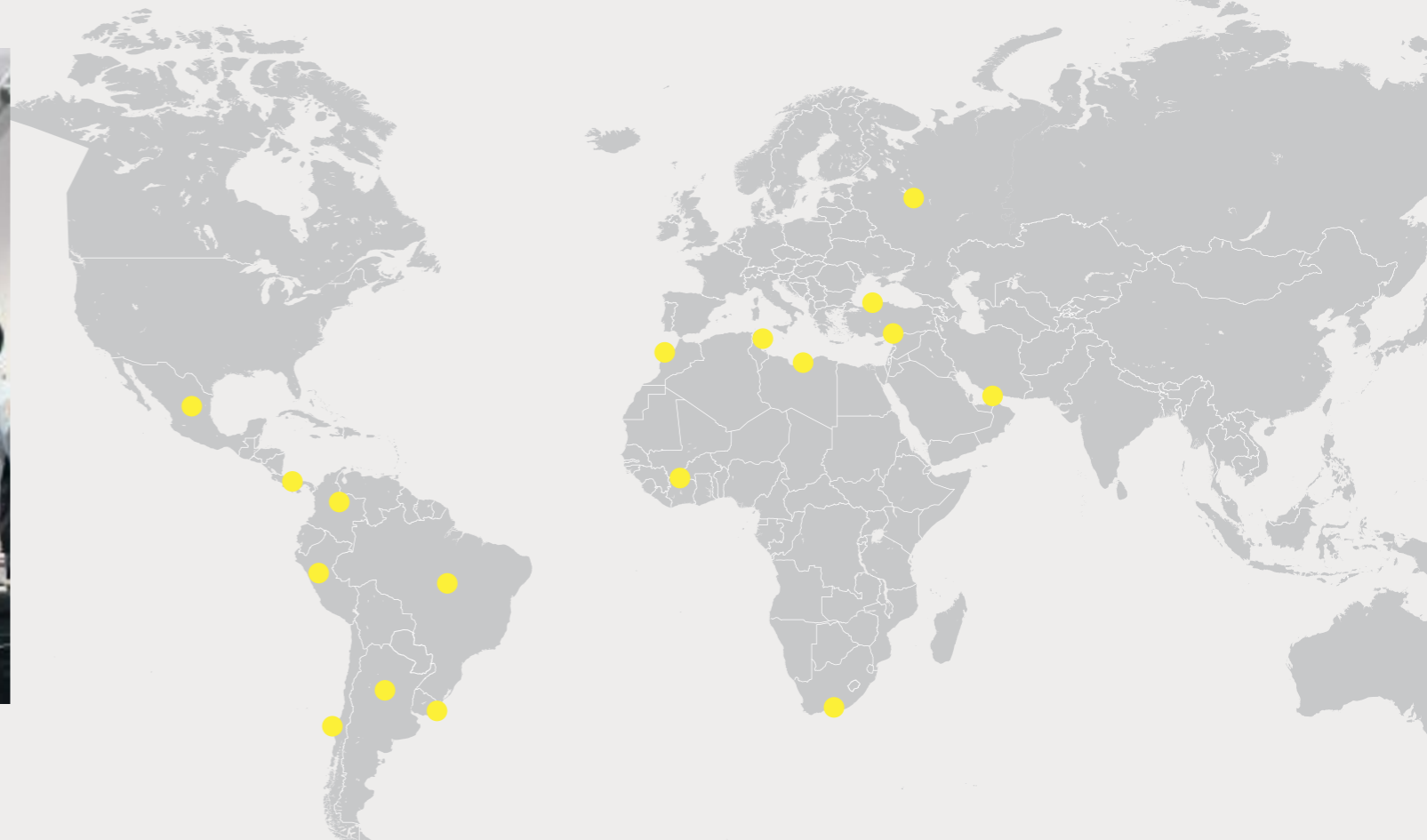

ICONE PERSONALIZZATE  
CUSTOMIZED LABELS



DIDATTICA SU ESPOSITORE  
DISPLAY POS







Soluzioni espositive  
Displays  
Présentoirs  
Expositores

EDDY cod. 3017/9003

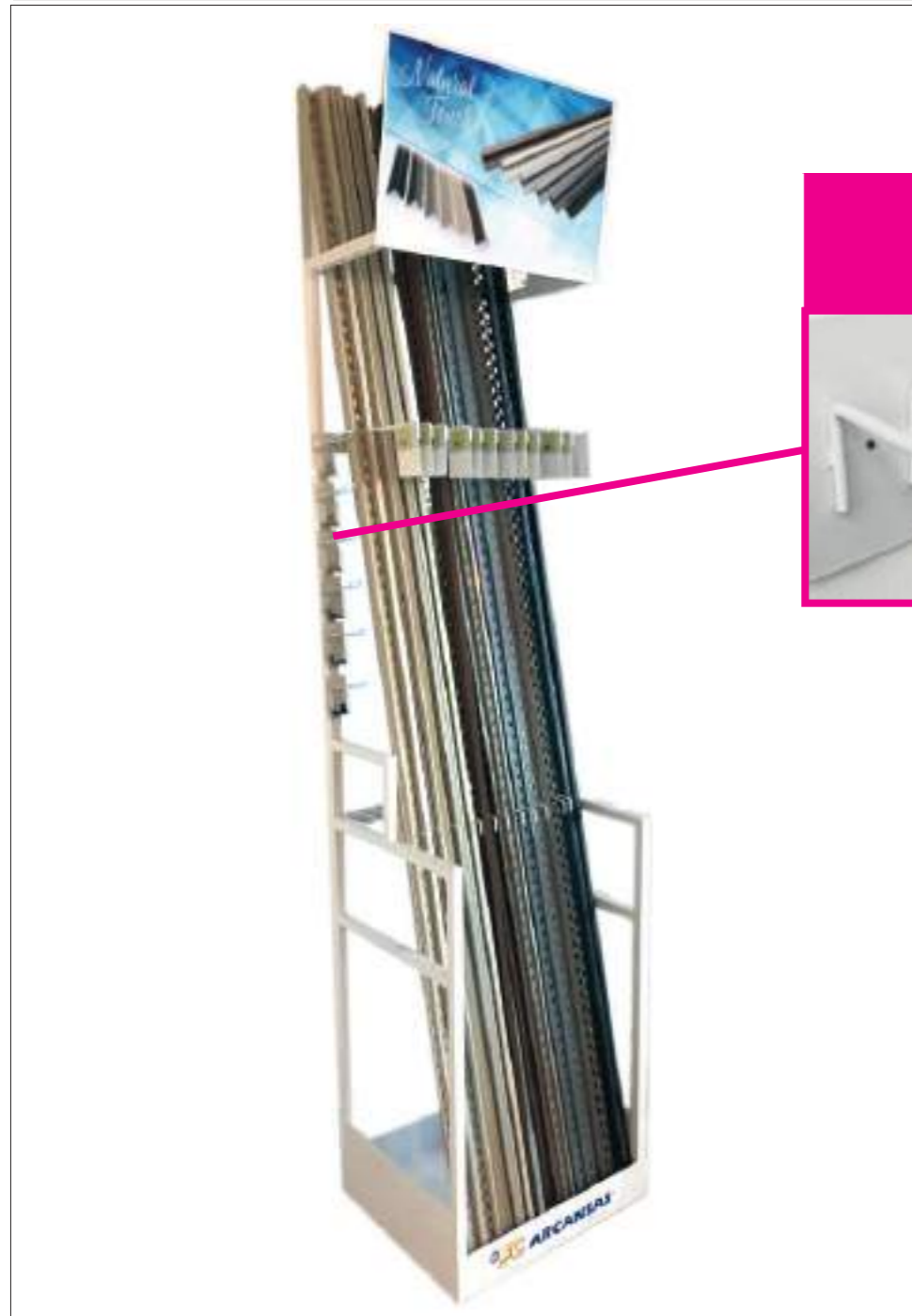

GANGIO PER BLISTER  
HOOK FOR BLISTER



EDDY per Profili balcone cod. 3017/9003



PROFILI BALCONE  
BALCONY PROFILES



LIVELLO 1 LEVEL 1	Larghezza width	Altezza min. soffitto Min. height	Profondità pcs - Depth	Capienza max. Max pcs
BARRE LUNGHE LONG LENGTHS	0,56 m	H. 3,00 m	0,47 m	12

MISURE GANCIO HOOK SIZES	Larghezza width	Profondità Depth
	5 cm	12 cm

LIVELLO 1 LEVEL 1	Larghezza width	Altezza min. soffitto Min. height	Profondità pcs - Depth	Capienza max. Max pcs
BARRE LUNGHE LONG LENGTHS	0,56 m	H. 3,00 m	0,47 m	12

EDDYBIG cod. 3018/9003



GANGIO PER BLISTER  
HOOK FOR BLISTER



LIVELLO 1 LEVEL 1	Larghezza	Altezza min. soffitto	Profondità pcs -	Capienza max. Max pcs
BARRE LUNGHE LONG LENGTHS	0,95 m	H. 3,00 m	0,47 m	22

	Larghezza width	Profondità Depth
MISURE GANCIO HOOK SIZES	5 cm	12 cm

Area for notes with horizontal dotted lines.

display units /

# profit

the character is recognized by its profile

We create **extremely modular and customized display units** for every need, thanks to our thirty years experience in the retail management sector.

Our display units guarantee **high sales performances**, maximizing the profitability of the spaces. Their original and extremely communicative design has very direct objectives: to encourage the customer to stop, inform him and create a product culture, simplify and **make easy the buying process**.



# +30%

sales increase

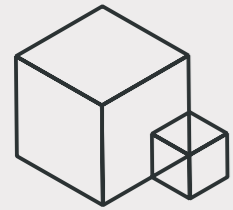

# +25%

increase in profitability per linear meter



**+20%**  
increased visibility with dedicated graphics



### HIGH PROFITABLE SPACE

Through a dedicated software, we study the **minimum job quantity**, ideal to guarantee the **maximum display capacity** and **ease of extraction of the product**



### INFOGRAPHIC AND VIDEO TUTORIAL

to **support the un-assisted sales** with instructions and **suggestions for product use**



### GRAPHICS AND DEDICATED COMMUNICATION

for an **increase of visibility** up to 20%



### HIGH QUALITY CERTIFIED MATERIALS

**maximum guaranteed load of 300 kg** for each display level and **ease of assembly**



### POCKETS FOR METAL SHEETS

our display units are the only ones to have **pockets for metal sheets included** in the structure



### CONTINUOUS SUPPORT

so that the system always works to the best of its ability (remodeling), according to market trends



logistics / **promptness**

the character is recognized by its profile

Our customers can dedicate themselves only to the important phases of their business: we take care of logistics. **We're the only contact** from transport to storage, to distribution.

We have technologically advanced systems for the management and monitoring of the activities related to distribution, storage and transport. Specific softwares plan accurately the routes and stretch, to ensure the **maximum precision and punctuality in the distribution of the goods.**



**100%**

total traceability for each order up to the client



**48h**

average time for order execution in Italy

logistics /

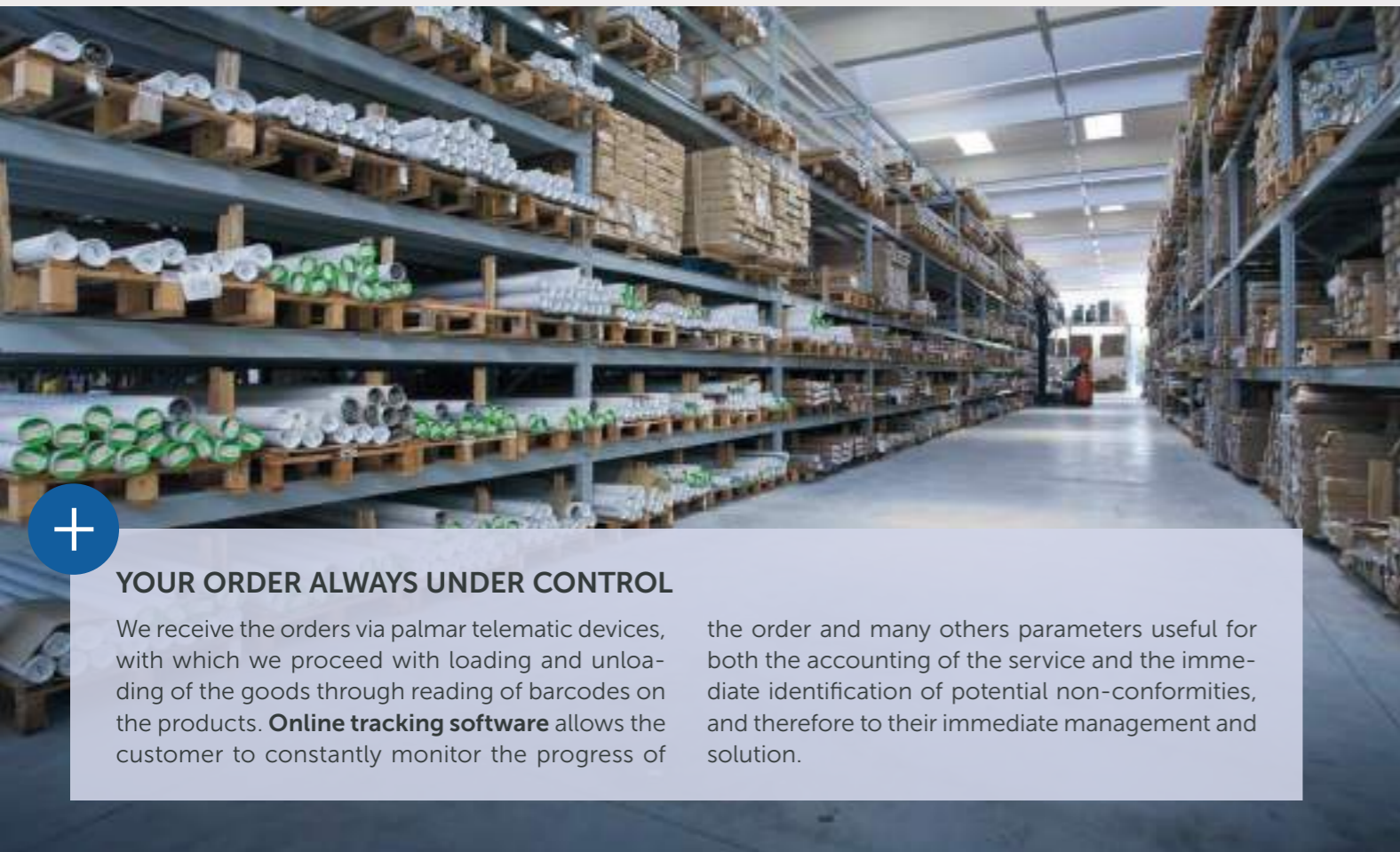

**YOUR ORDER ALWAYS UNDER CONTROL**

We receive the orders via palmar telematic devices, with which we proceed with loading and unloading of the goods through reading of barcodes on the products. **Online tracking software** allows the customer to constantly monitor the progress of

the order and many others parameters useful for both the accounting of the service and the immediate identification of potential non-conformities, and therefore to their immediate management and solution.



packaging / **pro**tection

the character is recognized by its profile

Choose the solution that best fits your needs. We offer our customers a range of **packaging solutions made purposely for every need:** carton pallets, carton boxes, customized pallets, tubes.

We make your orders special: we do not just think about the delivery, but also about the organisation inside the pallet, placing the materials in a safe way and identifying them with appropriate labels.

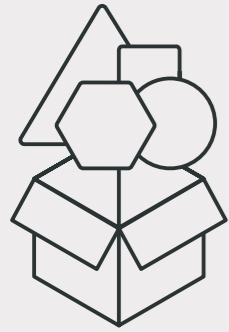

**10**

types of dedicated different packagings

packaging /



Tubes



Carton Box



Customized pallet



Carton Pallet

**WORLDWIDE IN COMPLETE SECURITY**

With our packagings and packages, it is possible to make shipments all over the world in total safety, keeping intact the quality of the goods transported.

The occupied space is optimized to a minimum: our packagings, in fact, can be overlapped thanks to the internal steel brackets.



039	8013237037253	185
039A	8013237037260	185
040	8013237037277	185
040/S/90	8013237135584	65
040/S/93	8013237135591	83
040A	8013237037284	185
040D/100	8013237143633	109
040D/101	8013237143640	109
040D/102	8013237143657	109
040D/103	8013237143664	109
040D/104	8013237143671	109
040D/105	8013237143688	109
040D/90	8013237144159	63
040D/93	8013237144166	79
041/100	8013237142858	109
041/101	8013237142865	109
041/102	8013237142872	109
041/103	8013237142889	109
041/104	8013237142896	109
041/105	8013237142902	109
041/61	8013237081362	95
041/62	8013237064501	95
041/63	8013237065331	95
041/64	8013237069438	79
041/65	8013237070120	95
041/66	8013237070144	95
041/67	8013237070267	95
041/68	8013237070274	95
041/90	8013237044176	65
041/93	8013237044183	79
041/95	8013237052690	79
041/96	8013237052706	95
041/99	8013237052980	79
041/99S	8013237052997	95
041/S/90	8013237135553	65
041/S/93	8013237135560	83
041D/S/90	8013237137878	65
041D/S/93	8013237137854	81
041E/100	8013237145019	109
041E/101	8013237145026	109
041E/102	8013237145033	109
041E/103	8013237145040	109
041E/104	8013237145057	109
041E/105	8013237145064	109
042/90	8013237044152	69
042/93	8013237044169	85
042A/93	8013237052300	85
043/100	8013237142919	109
043/101	8013237142926	109
043/102	8013237142933	109
043/103	8013237142940	109
043/104	8013237142957	109
043/105	8013237142964	109
043/61	8013237085148	95
043/62	8013237064518	95
043/63	8013237065348	95
043/64	8013237069452	79
043/65	8013237070137	95
043/66	8013237070151	95
043/67	8013237070281	95
043/68	8013237070298	95
043/90	8013237046682	63
043/93	8013237046699	79
043/95	8013237052898	79
043/96	8013237052904	95
043/99	8013237052874	79
043/99S	8013237052881	95
043/S/90	8013237135560	65
043/S/93	8013237135577	81

043D/S/90	8013237137885	65
043D/S/93	8013237137861	81
044/90	8013237058272	201
044/90	8013237058272	211
044/90S	8013237058517	201
044/90S	8013237058517	211
044C	8013237064259	215
044C/93	8013237078034	215
044D	8013237064266	215
044E	8013237064273	215
044E/90	8013237140205	201
044E/90	8013237140205	211
044E/90S	8013237064303	201
044E/90S	8013237064303	211
044E/90S/B	8013237064242	203
044E/90S/B	8013237064242	211
044E/90S/B	8013237064242	215
044E/93	8013237067045	201
044E/93	8013237067045	211
044E/93/B	8013237078027	201
044E/93/B	8013237078027	211
044F/90/B	8013237066239	215
044F/90/B	8013237066239	203
044F/93/B	8013237080570	201
044F/93/B	8013237080570	211
044G/90S	8013237069803	201
044G/90S	8013237069803	213
045B/01	8013237045210	173
045B/03	8013237045234	173
045B/15	8013237025700	173
045B/41	8013237045258	173
045B1/01	8013237045227	173
045B1/03	8013237025427	173
045B1/15	8013237004996	173
045B1/40	8013237139681	173
045B1/41	8013237045265	173
045B1/42	8013237139698	173
045C/01	8013237045319	173
045C/03	8013237028794	173
045C/15	8013237005016	173
045C/41	8013237045357	173
045D1/01	8013237045418	173
045D1/03	8013237028985	173
045D1/15	8013237005078	173
045D1/41	8013237005085	173
045E/01	8013237045517	173
045E/03	8013237031800	173
045E/15	8013237045562	173
045E/41	8013237045555	173
045L2/01	8013237145781	267
045L3/01	8013237147051	267
046B1/90	8013237005214	165
046B1/91	8013237005221	165
046B4/90	8013237005269	165
046B4/91	8013237005276	165
057C	8013237006808	163
057D	8013237006846	163
061B6	8013237061265	47
061B6A	8013237060398	47
061B7	8013237061272	47
061B7B	8013237060404	47
061E	8013237007614	57
061E/90	8013237072148	57
061E/93	8013237133337	77
061E1	8013237061517	57
061E1/63	8013237144951	93
061E1/90	8013237007638	57
061E1/93	8013237133672	77
061E1/F/90	8013237147105	59
061E1/F/N	8013237137977	59
061E2/90	8013237138509	57
061E2/F/90	8013237138714	59
061E2/F/N	8013237138707	59

061F9	8013237061692	57
061F9/63	8013237144968	93
061F9/90	8013237008086	57
061F9/91	8013237008109	57
061F9/93	8013237029777	77
061F9/F/90	8013237135461	59
061F9/F/91	8013237136000	59
061F9/F/93	8013237135478	77
061F9/F/N	8013237137984	59
061F92	8013237066741	57
061F92/F/90	8013237137915	59
061F92/F/93	8013237137922	77
061F92/F/N	8013237138493	59
061F9C	8013237040239	61
061F9C/90	8013237040253	61
061F9C/91	8013237040260	61
061G	8013237061760	57
061G/63	8013237144975	93
061G/90	8013237008345	57
061G/91	8013237008369	57
061G/93	8013237028398	77
061G/F/90	8013237135485	59
061G/F/93	8013237135492	77
061G/F/N	8013237137991	59
061G1/F/N	8013237138691	59
061G2	8013237066758	57
061G2/90	8013237133580	57
061G2/F/90	8013237137892	59
061G2/F/93	8013237137908	77
061G8	8013237072155	57
061G8/100	8013237145316	107
061G8/101	8013237145323	107
061G8/102	8013237145330	107
061G8/103	8013237145347	107
061G8/104	8013237145354	107
061G8/105	8013237145361	107
061G8/63	8013237144982	93
061G8/90	8013237072162	57
061G8/93	8013237144067	77
061GC	8013237040246	61
061GC/90	8013237036508	61
061GC/91	8013237040215	61
061H	8013237008574	57
061H/63	8013237144999	93
061H/90	8013237025878	57
061H/91	8013237025113	57
061H/93	8013237133344	77
061H/F/90	8013237136031	59
061H/F/N	8013237138004	59
061H1/F/90	8013237138684	59
061H1/F/N	8013237138677	59
061H3	8013237138769	57
061H3/90	8013237138752	57
061H4/63	8013237145002	93
061H4/90	8013237144074	57
061H4/93	8013237144081	77
061H5/90	8013237144098	57
061H5/93	8013237144104	77
061R1L	8013237611811	25
061RL	8013237049614	25
061RL/430	8013237137700	27
061RL/SL	8013237140328	25
061RL2	8013237066789	27
061RL2/430	8013237137755	27
061RS	8013237049621	25
061RS2	8013237069957	25
061SL	8013237049607	25
061SL/430	8013237137717	27
061SL/SL	8013237063009	25
061SL2	8013237066536	25
061SL2/430	8013237137762	27
061SS	8013237049638	25
061SS2	8013237069964	25

061TL	8013237049645	25
061TL/430	8013237137724	27
061TL/SL	8013237140335	25
061TS	8013237049652	25
061TS2	8013237138554	25
061VL	8013237139179	25
067	8013237009823	163
067A	8013237009830	163
070D1	8013237070410	209
070D17/01	8013237010898	225
070D17/03	8013237010980	225
070D17/10	8013237010997	225
070D17A/01	8013237011093	229
070D17A/03	8013237011192	229
070D17A/10	8013237011260	229
070D17B/01	8013237704827	227
070D17B/03	8013237704179	227
070D17B/10	8013237031442	227
070D17C/01	8013237704834	227
070D17C/03	8013237025410	227
070D17C/10	8013237028787	227
070D17F/01	801323704865	231
070D17F/03	8013237011376	231
070D17F/10	801323704810	231
070D17G/01	8013237704872	231
070D17G/03	801323708733	231
070D17G/10	801323708719	231
070D17H/01	8013237704889	231
070D17H/03	801323708917	231
070D17H/10	8013237704919	231
070D17M/01	8013237070489	231
070D17M/03	8013237050009	231
070D17M/10	8013237980177	231
070D17N/01	8013237011383	231
070D17N/03	8013237032401	231
070D17N/10	8013237980184	231
070D17O/01	8013237011390	227
070D17O/03	8013237070427	227
070D17O/10	8013237091194	227
070D17P/01	8013237011451	231
070D17P/03	8013237032395	231
070D17P/10	8013237980191	231
070D18	8013237704186	207
070D19	8013237704193	209
070D1R	8013237031718	209
070D2	8013237011499	209
070D20	8013237704209	209
070D21	8013237070434	209
070D2R	8013237031732	209
070D3/01	8013237011567	229
070D3/03	8013237011581	229
070D3/10	8013237011598	229
070D4	8013237070441	209
070D4R	8013237031725	209
070D6	8013237070465	207
070L/01	8013237031688	233
070M/01	8013237031695	233
071A	8013237011949	161
071B3A	8013237012076	161
071C	8013237007133	161
071D7	8013237031701	207
071H	8013237012274	161
072	8013237012298	161
072A	8013237007218	161
081B1/01	8013237050849	223
081B2/01	8013237144593	223
081E/01	8013237012830	237
081E/03	8013237012847	237

081E/21	8013237037000	237
081E/23	8013237082185	237
081E/24	8013237082192	237
081E/26	8013237190002	237
081E/27	8013237082215	237
081E/28	8013237082222	237
081E/M/01	8013237136109	235
081E/M/17	8013237136123	235
081L/01	8013237012977	237
081L/03	8013237029371	237
081L/04	8013237012984	237
081L/07	8013237091200	237
081L/09	8013237091217	237
081L/103	8013237050672	237
081L/104	8013237051150	237
081L/17	8013237051617	237
081L/23	8013237082246	237
081L/24	8013237082253	237
081L/26	8013237190019	237
081L/27	8013237082277	237
081L/M/01	8013237136116	235
081L/M/17	8013237136093	235
081U/01	8013237081317	221
081U/03	8013237013370	221
081U/10	8013237813109	221
081UA/01	8013237181314	221
081UA/03	8013237029210	221
081UA/10	8013237028978	221
081V/01	8013237013387	219
081V/01/B	8013237062682	219
081V/03	8013237013394	219
081V/10	8013237013400	219
081VA/01	8013237025731	219
081VA/01/B	8013237062705	219
081VA/03	8013237029173	219
081VA/10	8013237028954	219
081X/01	8013237081515	221
081X/03	8013237815035	221
081X/10	8013237815103	221
081XA/01	8013237181512	221
081XA/03	8013237029180	221
081XA/10	8013237028961	221
081XB/01	8013237042141	239
081XBA/01	8013237043032	239
081XC/01	8013237065362	239
081XCA/01	8013237065379	239
081XCB/01	8013237066390	239
081XCBA/01	8013237066383	239
081Z/01	8013237081713	221
081Z/03	8013237817039	221
081Z/10	8013237817107	221
081ZA/01	8013237181710	221
081ZA/03	8013237081331	221
081ZA/10	8013237091255	221
082/01	8013237066208	219
082A/01	8013237066192	219
083/01	8013237067298	239
083A/01	8013237066215	239
084/01	8013237067304	239
084A/01	8013237066222	239
1000	8013237010003	187
1002	8013237010027	187
1003	8013237010034	187
1010	8013237010102	187
1010/93	8013237510107	187
1010A	8013237010105	187
1010A2/GL01	8013237087173	189
1010A2/GL10	8013237131777	189
1010A2/GL12	8013237131784	189
1010A2/GL19	8013237131791	189
1010A2/GL20	8013237133351	189
1010A2/GL30	8013237131159	189
1010A2/GLRAME	8013237133368	189

1011	8013237010119	187
1012	8013237010126	187
1012/93	8013237510121	187
1013	8013237010133	187
1017/GL01	8013237087043	189
1017/GL10	8013237087104	189
1017/GL12	8013237087135	189
1017/GL19	8013237087128	189
1017/GL20	8013237087142	189
1017/GL30	8013237087111	189
1017/GLRAME	8013237087159	189
1021	8013237010218	187
135A1/B	8013237024987	271
135AC/01	8013237139971	273
135AC/02	8013237139988	273
135AC/03	8013237139995	273
135AC/04	8013237140007	273
135AC/05	8013237140014	273
135AC/06	8013237146979	273
135AC/08	8013237140021	273
135AC/09	8013237146986	273
135AC1/08	8013237147013	273
135AC2/01	8013237147020	273
135AC2/02	8013237147037	273
135AC2/05	8013237147044	273
135AR/01	8013237140038	275
135AR/02	8013237140076	275
135AR/03	8013237140083	275
135AR/04	8013237140090	275
135B1/B	8013237024994	271
135C1/B	8013237025007	271
135E1/B	8013237025014	271
135L1/B	8013237024956	271
135M1/B	8013237025021	271
135N1/B	8013237024932	271
135P1/B	8013237024949	271
135Q1/B	8013237024963	271
135Q2/B	8013237146993	271
135R1/B	8013237025038	271
135R2/B	8013237060558	271
135R3/B	8013237060633	271
135S1/B	8013237025045	271
135U1/B	8013237024741	271
135V1/B	8013237024970	271
135V2/B	8013237147006	271
1506B	8013237083588	163
1507B	8013237083595	163
1508B	8013237083601	163
1509B	8013237083618	163
1547E	8013237064334	181
1547G	8013237064358	181
1548E	8013237064341	181
1548E/12	8013237071448	181
1548E/13	8013237068356	181
1548E/14	8013237071455	181
1548E/15	8013237068363	181
1548G	8013237064365	181
1549E	8013237015152	181
1549G	8013237064372	181
1557B	8013237064389	181
1557N	8013237064396	181
1558B	8013237064402	181
1558N	8013237064419	181
1559B	8013237064426	181
1559N	8013237064433	181
1560/01	8013237080143	177
1560/09	8013237077686	177
1560/09	8013237077686	179
1560/12	8013237077624	177
1560/12	8013237077624	179
1560/125	8013237078102	177
1560/125	8013237078102	179

1560/13	8013237078041	177
1560/13	8013237078041	179
1560/131	8013237077754	177
1560/131	8013237077754	179
1560/133	8013237077761	177
1560/133	8013237077761	179
1560/139	8013237077778	177
1560/139	8013237077778	179
1560/14	8013237077631	177
1560/14	8013237077631	179
1560/16	8013237077648	177
1560/16	8013237077648	179
1560/17	8013237077655	177
1560/17	8013237077655	179
1560/18	8013237078089	177
1560/18	8013237078089	179
1560/20	8013237077662	177
1560/20	8013237077662	179
1560/21	8013237080150	177
1560/21	8013237080150	179
1560/905	8013237077730	177
1560/905	8013237077730	179
1560/93	8013237077747	177
1560/93	8013237077747	179
1560B/01	8013237080563	177
1560B/01	8013237080563	179
1560B/09	8013237077846	177
1560B/09	8013237077846	179
1560B/12	8013237077785	177
1560B/12	8013237077785	179
1560B/125	8013237079611	177
1560B/125	8013237079611	179
1560B/13	8013237078058	177
1560B/13	8013237078058	179
1560B/131	8013237077891	177
1560B/131	8013237077891	179
1560B/133	8013237077907	177
1560B/133	8013237077907	179
1560B/139	8013237077914	177
1560B/139	8013237077914	179
1560B/14	8013237077792	177
1560B/14	8013237077792	179
1560B/16	8013237077808	177
1560B/16	8013237077808	179
1560B/17	8013237077815	177
1560B/17	8013237077815	179
1560B/18	8013237078096	177
1560B/18	8013237078096	179
1560B/20	8013237077822	177
1560B/20	8013237077822	179
1560B/21	8013237080839	177
1560B/21	8013237080839	179
1560B/905	8013237077877	177
1560B/905	8013237077877	179
1560B/93	8013237077884	177
1560B/93	8013237077884	179
245/100	8013237036560	135
245/101	8013237036577	135
245/102	8013237036591	151
245/103	8013237036607	151
245/104	8013237036614	151
245/105	8013237036621	151
245/106	8013237036638	151
245/107	8013237036645	151
245/108	8013237036652	151
245/109	8013237036669	151
245/111	8013237036683	135
245/112	8013237042011	151
245/113	8013237044794	151
245/114	8013237044800	151
245/23	8013237036584	151
245/24	8013237036676	151
245/27	8013237050375	151

245/28	8013237050382	151
246/100	8013237036690	135
246/101	8013237036706	135
246/102	8013237036713	151
246/103	8013237036720	151
246/104	8013237036737	151
246/105	8013237036744	151
246/106	8013237036751	151
246/107	8013237036768	151
246/108	8013237036775	151
246/109	8013237036782	151
246/111	8013237036799	135
246/112	8013237042028	151
246/113	8013237044817	151
246/114	8013237044824	151
246/23	8013237036805	151
246/24	8013237036812	151
246/27	8013237050399	151
246/28	8013237050405	151
247/01	8013237036829	133
247/03	8013237036874	133
247/04	8013237036881	133
247/05	8013237036850	133
247/07	8013237036836	133
247/09	8013237036867	133
247/17	8013237036843	133
247/19	8013237036800	133
248/01	8013237036898	133
248/03	8013237036904	133
248/04	8013237036911	133
248/05	8013237036935	133
248/07	8013237036928	133
248/09	8013237036959	133
248/17	8013237036942	133
248/19	8013237037697	133
249/100	8013237056032	135
249/101	8013237056001	135
249/111	8013237056025	135
249/114	8013237056018	151
250B/01	8013237016777	141
250B/03	8013237016791	141
250B/04	8013237016807	141
250B/07	8013237016838	143
251/01	8013237016951	141
251A/01	8013237511012	141
251A/03	8013237017248	141
251A/04	8013237017262	141
251A/05	8013237017286	143
251A/07	8013237017316	143
251A/08	8013237017330	143
251A/09	8013237017347	143
251A/30	8013237017422	157
251A/31	8013237017439	157
251A/32	8013237017446	157
251A/33	8013237017453	157
251A/34	8013237017460	157
251A/36	8013237031572	157
251A/A/01	8013237139773	147
251AH8	8013237070809	145
251AH8/BL2	8013237086503	145
251AH8/BLISTER	8013237083625	145
252/01	8013237252014	141
252A/01	8013237002527	141
252A/03	8013237017774</	



252A/34	8013237018009	157
252A/36	8013237031596	157
252A/A/01	8013237139780	147
252AH10	8013237070816	145
252AH10/BLISTER	8013237083632	145
253A/01	8013237018160	125
253A/03	8013237028633	125
253A/04	8013237028657	125
253A/05	8013237028664	125
253A/07	8013237028688	127
253A/09	8013237028701	127
253A/17	8013237028718	127
253A/A/01	8013237136345	121
253A/A/03	8013237135850	121
253A/A/17	8013237137946	121
253A7/01	8013237066550	125
253A7/03	8013237066598	125
253A7/07	8013237066611	127
253B/01	8013237532017	125
253B/03	8013237025595	125
253B/04	8013237025601	125
253B/05	8013237025618	125
253B/07	8013237025298	127
253B/09	8013237025281	127
253B/17	8013237050689	127
253B/A/01	8013237136352	121
253B/A/02	8013237140366	123
253B/A/03	8013237135874	121
253B/A/05	8013237135904	123
253B/A/09	8013237135898	123
253B/A/16	8013237135881	121
253B/A/17	8013237135867	121
253B/A/19	8013237135911	123
253B/A/22	8013237140380	123
253B/A/37	8013237142308	123
253B/A/38	8013237140786	123
253B1	8013237060879	129
253B1/BLISTER	8013237139759	129
253B2	8013237060886	129
253B2/BLISTER	8013237083649	129
253B3	8013237060893	129
253B3/BLISTER	8013237083656	129
253B4	8013237060909	129
253B4/BLISTER	8013237138837	129
253B7/01	8013237066567	125
253B7/03	8013237066604	125
253B7/07	8013237066628	127
253C/01	8013237018177	125
253C/03	8013237018184	125
253C/04	8013237018191	125
253C/05	8013237018207	125
253C/07	8013237018214	127
253C/09	8013237018238	127
253C/17	8013237050696	127
253C/A/01	8013237136369	121
253C/A/02	8013237140373	123
253C/A/03	8013237135935	121
253C/A/16	8013237135942	121
253C/A/17	8013237135928	121
253C7/01	8013237066574	125
253C7/03	8013237066581	125
253C7/07	8013237066635	127
254A	8013237029937	69
254A/51	8013237018269	101
254A/62	8013237064457	101
254A/63	8013237065317	101
254A/64	8013237069469	85
254A/66	8013237070175	101
254A/68	8013237070311	101
254A/90	8013237018375	69
254A/91	8013237018399	69
254A/92	8013237018412	69
254A/93	8013237254131	85

254A/94	8013237018443	85
254A/95	8013237052652	85
254A/96	8013237052669	101
254A/99	8013237052935	85
254A/99S	8013237052942	101
254A/F/115	8013237148652	73
254A/F/90	8013237135508	73
254A/F/N	8013237137960	73
254A2/62	8013237066857	101
254A2/63	8013237066864	101
254A2/90	8013237066734	69
254A2/93	8013237066710	85
254A2/94	8013237066772	85
254A2/95	8013237066826	85
254A2/96	8013237066819	101
254A2/F/90	8013237137847	73
254A2/F/N	8013237137823	73
254A3/90	8013237081218	69
254A3/93	8013237081225	85
254B	8013237029944	69
254B/51	8013237018467	101
254B/90	8013237018504	69
254B/91	8013237018528	69
254B/92	8013237018542	69
254B/93	8013237018566	85
254B/94	8013237018580	85
254B/99	8013237053017	85
254B/99S	8013237053024	101
254B/F/90	8013237135522	73
254B/F/N	8013237137953	73
254B2/51	8013237137793	101
254B2/90	8013237066727	69
254B2/93	8013237066703	85
254B2/94	8013237066765	85
254B2/F/90	8013237137830	73
254B2/F/N	8013237137816	73
254B3/90	8013237081164	69
254B3/93	8013237081171	85
254BH10	8013237079857	87
254BH10/BLISTER	8013237083694	87
254BH12	8013237079864	87
254BH12/BLISTER	8013237138851	87
254BH8	8013237079840	87
254BH8/BLISTER	8013237083663	87
254H10	8013237079826	71
254H10/BLISTER	8013237083687	71
254H10/R/BL	8013237140281	103
254H10/T/BL	8013237140267	103
254H12	8013237079833	71
254H12/BLISTER	8013237138844	71
254H12/R/BL	8013237140298	103
254H12/T	8013237144135	103
254H12/T/BL	8013237140274	103
254H8	8013237079819	71
254H8/BLISTER	8013237083670	71
254Q1	8013237065669	69
254Q1/62	8013237064464	101
254Q1/63	8013237065324	101
254Q1/64	8013237069483	85
254Q1/66	8013237070199	101
254Q1/68	8013237070335	101
254Q1/90	8013237018887	69
254Q1/93	8013237018917	85
254Q1/94	8013237018931	85
254Q1/95	8013237052850	85
254Q1/96	8013237052867	101
254Q1/99	8013237052836	85
254Q1/99S	8013237052843	101
254Q1A/62	8013237066871	101
254Q1A/63	8013237066888	101
254Q1A/95	8013237066833	85
254Q1A/96	8013237066840	101
255	8013237019112	219

255A/01	8013237042219	125
255A/03	8013237042226	125
255A/04	8013237042233	125
255A/05	8013237042240	125
255A/07	8013237042257	127
255A/09	8013237042264	127
255A/17	8013237042271	127
255A/A/01	8013237136376	121
255A/A/17	8013237135973	121
255B/100	8013237042080	131
255B/101	8013237042097	131
255B/102	8013237045982	149
255B/103	8013237045999	149
255B/104	8013237046002	149
255B/105	8013237046019	149
255B/106	8013237046026	149
255B/107	8013237046033	149
255B/108	8013237046040	149
255B/109	8013237046057	149
255B/111	8013237046064	131
255B/112	8013237046071	149
255B/113	8013237046088	149
255B/114	8013237046095	149
255B/23	8013237045968	149
255B/24	8013237045975	149
255B/26	8013237046330	149
255B/27	8013237046101	149
255B/28	8013237046118	149
255B/A/23	8013237135959	123
255C/100	8013237045937	131
255C/101	8013237046323	131
255C/102	8013237046170	149
255C/103	8013237046187	149
255C/104	8013237046200	149
255C/105	8013237046217	149
255C/106	8013237046224	149
255C/107	8013237046231	149
255C/108	8013237046248	149
255C/109	8013237046163	149
255C/111	8013237046255	131
255C/112	8013237046262	149
255C/113	8013237046279	149
255C/114	8013237046286	149
255C/23	8013237046132	149
255C/24	8013237046156	149
255C/26	8013237046293	149
255C/27	8013237046309	149
255C/28	8013237046316	149
255C/A/23	8013237138738	123
256	8013237019136	233
257A3L	8013237046873	35
257A3L/430	8013237137731	41
257A3L/SL	8013237062934	35
257A3L2/430	8013237137779	41
257A35	8013237046910	35
257A5L	8013237046880	35
257A5L/430	8013237137748	41
257A5L/SL	8013237062927	35
257A5L2	8013237066796	35
257A5L2/430	8013237137786	41
257A5R	8013237147136	43
257A5S	8013237046927	35
257A5S2	8013237066802	35
257A6L	8013237019242	35
257B1	8013237019297	53
257B6L	8013237046620	35
257B6L/SL	8013237062941	35
257B6S	8013237046637	35
257C	8013237053987	37
257C/BLISTER	8013237083700	37
257C/BLISTER/SL	8013237138783	39
257C1	8013237053994	37
257C1/BLISTER	8013237083724	37

257C1/BLISTER/SL	8013237138776	39
257C1R	8013237147143	45
257C1S	8013237147310	45
257C2	8013237054007	37
257C2/BLISTER	8013237138882	37
257C2/BLISTER/SL	8013237138790	39
257C3	8013237060831	37
257C3/BLISTER	8013237083717	37
257C4	8013237060848	37
257C4/BLISTER	8013237083731	37
257C5	8013237060855	37
257C5/BLISTER	8013237138899	37
257E	8013237019419	53
257E/C	8013237063030	53
257E2/C	8013237066895	53
257F	8013237047344	53
257F/C	8013237064617	53
257F2/C	8013237066901	53
258	8013237047269	29
258/M	8013237069971	29
258/M/SL	8013237138592	29
258/SL	8013237062903	29
258A	8013237047276	29
258A/M	8013237069988	29
258B	8013237019440	29
258B/M	8013237069995	29
258B/M/SL	8013237138578	29
258B/SL	8013237062910	29
258BH10	8013237079895	83
258BH10/BLISTER	8013237138820	83
258BH12	8013237079901	83
258BH12/BLISTER	8013237138875	83
258BH8	8013237146771	83
258C	8013237019563	29
258C/M	8013237138585	29
258E	8013237133207	29
258E/M	8013237138615	29
258E/M/SL	8013237138622	29
258E/SL	8013237138639	29
258E1	8013237133283	29
258E1/M	8013237138608	29
258F	8013237144869	29
258H10	8013237079871	67
258H10/100	8013237143534	115
258H10/100/BL	8013237144661	115
258H10/101	8013237143541	111
258H10/101/BL	8013237144609	111
258H10/102	8013237144203	111
258H10/102/BL	8013237144623	111
258H10/103	8013237144210	113
258H10/103/BL	8013237144647	113
258H10/104	8013237143558	115
258H10/104/BL	8013237144708	115
258H10/105	8013237143565	113
258H10/105/BL	8013237144685	113
258H10/BLISTER	8013237138813	67
258H10/R/BL	8013237140243	99
258H10/T	8013237144142	97
258H10/T/BL	8013237140236	97
258H11/100	8013237145101	115
258H11/100/BL	8013237145187	115
258H11/101	8013237145095	111
258H11/101/BL	801	

258H12/100/BL	8013237144678	115
258H12/101	8013237143589	111
258H12/101/BL	8013237144616	111
258H12/102	8013237143596	111
258H12/102/BL	8013237144630	111
258H12/103	8013237143602	113
258H12/103/BL	8013237144654	113
258H12/104	8013237143619	115
258H12/104/BL	8013237144715	115
258H12/105	8013237143626	113
258H12/105/BL	8013237144692	113
258H12/BLISTER	8013237138868	67
258H12/R/BL	8013237140250	99
258H12/T/BL	8013237140229	97
258HB/100	8013237144739	115
258HB/100/BL	8013237144791	115
258HB/101	8013237144746	111
258HB/101/BL	8013237144807	111
258HB/102	8013237144753	111
258HB/102/BL	8013237144814	111
258HB/103	8013237144760	113
258HB/103/BL	8013237144821	113
258HB/104	8013237144777	115
258HB/104/BL	8013237144838	115
258HB/105	8013237144784	113
258HB/105/BL	8013237144845	113
258R/C	8013237062897	49
258R1/L	8013237063337	49
258R2/C	8013237066918	49
258S/C	8013237064624	49
258S1/L	8013237070687	49
258S2/C	8013237066925	49
258T	8013237058180	31
258T/BLISTER/SL	8013237138905	33
258T/C	8013237132705	51
258T/SL	8013237063542	33
258T1	8013237058579	31
258T1/BLISTER/SL	8013237138806	33
258T1/C	8013237132699	51
258T1/SL	8013237063559	33
258T1S	8013237061326	31
258T1S/BLISTER	8013237083755	31
258T2	8013237133313	31
258T2/BLISTER/SL	8013237140106	33
258T2S	8013237133320	31
258T2S/BLISTER	8013237139964	31
258TS	8013237061319	31
258TS/BLISTER	8013237083779	31
259A	8013237019570	193
259A1	8013237019587	193
259A12	8013237066680	193
259B	8013237019600	193
259B1	8013237019617	193
259B12	8013237066697	193
259C	8013237019631	193
259C1	8013237019648	193
259D	8013237019662	193
259D1	8013237019686	193
259E	8013237071578	193
259F	8013237142018	193
259G	8013237071585	193
259L	8013237133436	193
260	8013237019709	197
260A	8013237019716	197
260D	8013237019761	197
260D3	8013237148522	197
260E	8013237019785	197
260L	8013237019815	197
260M	8013237019822	197
270A	8013237019891	195
270D	8013237019914	197
270D1	8013237019921	197
270D2	8013237980306	197

270F	8013237019945	197
270M	8013237019976	197
295/09	8013237072087	155
295/13	8013237072094	155
295/19	8013237071868	155
295/21	8013237100032	155
295/905	8013237072100	155
296/09	8013237072056	155
296/13	8013237072049	155
296/19	8013237072032	155
296/21	8013237072063	155
296/905	8013237072070	155
320/100	8013237143121	243
320/60	8013237143084	243
320/70	8013237143091	243
320/80	8013237143107	243
320/90	8013237143114	243
321/100	8013237143176	243
321/60	8013237143138	243
321/70	8013237143145	243
321/80	8013237143152	243
321/90	8013237143169	243
322/100	8013237143220	243
322/60	8013237143183	243
322/70	8013237143190	243
322/80	8013237143206	243
322/90	8013237143213	243
323	8013237143237	245
380C	8013237020484	195
380D	8013237003807	195
380E	8013237020545	195
390/01	8013237020583	139
390/03	8013237020590	139
390M/L/01	8013237136598	119
391/01	8013237391010	139
391/03	8013237020682	139
391M/L/01	8013237136604	119
392/01	8013237021061	139
392/03	8013237021078	139
392B/01	8013237066543	139
392M/L/01	8013237136611	119
393/01	8013237021290	139
393/03	8013237142292	139
393M/L/01	8013237136628	119
397/KIT	8013237139155	277
430A	8013237131692	255
430A/100	8013237144883	261
430A/101	8013237144890	261
430A/102	8013237144906	261
430A/103	8013237144913	261
430A/104	8013237144920	261
430A/105	8013237144937	261
430A/7011	8013237143442	255
430A/8019	8013237140816	255
430A/9010	8013237143435	255
430A/L	8013237138226	253
430AGR1	8013237144050	255
430B	8013237132323	257
430B/100	8013237145682	263
430B/101	8013237145699	263
430B/102	8013237145583	263
430B/103	8013237145705	263
430B/104	8013237145590	263
430B/105	8013237145712	263
430B/7011	8013237143466	257
430B/8019	8013237141486	257
430B/9010	8013237143459	257
430C	8013237132330	259
430C/100	8013237145729	265
430C/101	8013237145736	265
430C/102	8013237145606	265
430C/103	8013237145743	265
430C/104	8013237145613	265

430C/105	8013237145750	265
430C/7011	8013237143527	259
430C/8019	8013237141493	259
430C/9010	8013237143510	259
850/63	8013237067137	167
850/93	8013237508500	167
850/95	8013237056858	167
850/96	8013237055639	167
850/99	8013237071004	167
850/995	8013237055646	167
850D/100	8013237143879	171
850D/101	8013237143886	169
850D/102	8013237143893	169
850D/103	8013237143909	169
850D/104	8013237143916	171
850D/105	8013237143923	171
850DA/100	8013237146412	171
850DA/101	8013237146429	169
850DA/102	8013237146436	169
850DA/103	8013237146443	169
850DA/104	8013237146450	171
850DA/105	8013237146467	171
851/63	8013237067151	167
851/93	8013237508517	167
851/95	8013237056872	167
851/96	8013237055677	167
851/99	8013237071127	167
851/995	8013237055684	167
851D	8013237083144	167
851D/100	8013237143930	171
851D/101	8013237143947	169
851D/102	8013237143954	169
851D/103	8013237143961	169
851D/104	8013237143978	171
851D/105	8013237143985	171
851DA/100	8013237146474	171
851DA/101	8013237146481	169
851DA/102	8013237146498	169
851DA/103	8013237146504	169
851DA/104	8013237146511	171
851DA/105	8013237146528	171
851M1	8013237082895	167
851P	8013237082932	167
852/63	8013237067175	167
852/93	8013237508524	167
852/95	8013237056896	167
852/96	8013237055714	167
852/99	8013237071141	167
852/995	8013237055721	167
852D	8013237083236	167
852D/100	8013237143992	171
852D/101	8013237144005	169
852D/102	8013237144012	169
852D/103	8013237144029	169
852D/104	8013237144036	171
852D/105	8013237144043	171
852DA/100	8013237146535	171
852DA/101	8013237146542	169
852DA/102	8013237146559	169
852DA/103	8013237146566	169
852DA/104	8013237146573	171
852DA/105	8013237146580	171
852N1	8013237082901	167
852P	8013237082949	167
853/63	8013237067199	167
853/93	8013237508531	167
853/95	8013237056919	167
853/96	8013237055752	167
853/99	8013237071769	167
853/995	8013237055769	167
853D	8013237083243	167
853P1	8013237082918	167
853R	8013237082956	167

855/63	8013237067212	167
855/93	8013237508555	167
855/95	8013237056933	167
855/96	8013237055790	167
855/99	8013237071776	167
855/995	8013237055806	167
855D	8013237083250	167
855Q1	8013237082925	167
855R	8013237082963	167
875/100	8013237143695	171
875/101	8013237143701	169
875/102	8013237143718	169
875/103	8013237143725	169
875/104	8013237143732	171
875/105	8013237143749	171
875A/100	8013237145521	171
875A/101	8013237144227	169
875A/102	8013237144258	169
875A/103	8013237145491	169
875A/104	8013237144289	171
875A/105	8013237145460	171
876/100	8013237143756	171
876/101	8013237143763	169
876/102	8013237143770	169
876/103	8013237143787	169
876/104	8013237143794	171
876/105	8013237143800	171
876A/100	8013237145538	171
876A/101	8013237144234	169
876A/102	8013237144265	169
876A/103	8013237145507	169
876A/104	8013237144296	171
876A/105	8013237145477	171
877/100	8013237143817	171
877/101	8013237143824	169
877/102	8013237143831	169
877/103	8013237143848	169
877/104	8013237143855	171
877/105	8013237143862	171
877A/100	8013237145545	171
877A/101	8013237144241	169
877A/102	8013237144272	169
877A/103	8013237145569	169
877A/104	8013237144302	171
877A/105	8013237145484	171
GU/500	8013237140311	248
TA/500	8013237140304	248

## CONDIZIONI COMMERCIALI

### Ordini, pagamenti e consegne:

1. Se non diversamente indicato, tutte le quantità sugli ordini vengono arrotondate alla quantità per convenzione del presente listino, altrimenti sarà applicato un incremento del prezzo di listino pari al 10%. La maggiorazione sarà del 20% nel caso in cui le quantità richieste siano inferiori a 10 pezzi. (Esempio di arrotondamento: da 11 a 14 arrotondamento a 10, da 15 a 19 arrotondamento a 20)
2. Pagamenti: prima fornitura, contrassegno.
3. Non saranno evase forniture con importi inferiori a €100,00 netto sconti.
4. Tutti gli ordini ricevuti entro le ore 11.00 verranno evasi entro le 24 ore.
5. Per consegne su appuntamento verificare con ufficio ordini fattibilità e sovrapprezzo.
6. Per spese di trasporto consultare l'ufficio commerciale di riferimento.

### Spese varie:

1. Porto Franco per importi fattura superiori a € 250,00.
  2. Per importi Fattura inferiori a € 250,00 verranno addebitati € 15,00 per spese amministrative.
- Rischi nel trasporto: La merce viaggia a rischio e pericolo dell'acquirente, anche se in porto Franco.

## CONDIZIONI GENERALI

### Disegni e documenti descrittivi:

Tutte le Fotografie, i disegni e i dati tecnici dei prodotti a catalogo hanno carattere informativo ed esemplificativo, quindi non impegnativo.

### Modifiche:

Arcansas Profili s.r.l si riserva il diritto di apportare modifiche ai propri prodotti, imballi e quant'altro senza obbligo di preavviso.

### Reclami:

I reclami per vizi o difetti apparenti (es. mancanza o danneggiamento) vanno presentati al corriere direttamente all'atto del ricevimento della merce e tempestivamente anche ad Arcansas Profili s.r.l, a mezzo riserva scritta sulla bolla di consegna specificando il tipo di anomalia, pena la decadenza di qualunque diritto di garanzia e del diritto di risarcimento. I reclami per vizi o difetti non individuabili con un diligente controllo al momento del ricevimento della merce (vizi o difetti occulti), dovranno essere notificati, a pena di decadenza, ad Arcansas Profili s.r.l mediante lettera raccomandata A.R. entro sette giorni dalla scoperta del vizio o difetto e comunque non oltre 12 mesi dalla consegna. Eventuali reclami non daranno diritto all'acquirente di sospendere o ritardare i pagamenti dovuti ad Arcansas Profili s.r.l.

### Garanzia e vizi:

Arcansas Profili s.r.l si impegna a sostituire i prodotti che presentino vizi, mancanza di qualità o difetti di conformità ad essa imputabili, verificatisi entro dodici mesi dalla consegna dei prodotti, purché gli stessi siano stati presentati tempestivamente nelle modalità precedentemente riportate. Arcansas Profili s.r.l. non garantisce la rispondenza dei prodotti a particolari specifiche o caratteristiche tecniche o la loro idoneità ad usi e/o utilizzi particolari, se non nella misura in cui tali caratteristiche siano state espressamente convenute nel contratto. In caso di vizi apparenti e/o occulti riconosciuti da Arcansas Profili s.r.l., l'acquirente ha diritto esclusivamente alla sostituzione del prodotto, che verrà accettato in reso solo in confezioni originali, integre e complete. Nessun prodotto potrà essere sostituito senza una preliminare autorizzazione scritta di Arcansas Profili s.r.l. La presente garanzia è sostitutiva delle garanzie e responsabilità previste per legge ed esclude ogni altra responsabilità di Arcansas Profili s.r.l comunque originata dai prodotti venduti, salvo il caso di dolo e colpa grave.

### Riserva di proprietà:

I prodotti rimangono di proprietà di Arcansas Profili s.r.l sino al loro completo pagamento da parte dell'acquirente. Il mancato pagamento, anche parziale, dà diritto ad Arcansas Profili s.r.l di recuperare la merce oggetto di fornitura, anche se in deposito presso terzi.

### Proprietà industriale e intellettuale:

Segni distintivi, fotografie di prodotti e/o tecnologie produttive e commerciali di Arcansas Profili s.r.l, non dovranno essere utilizzati o divulgati senza la previa autorizzazione scritta di Arcansas Profili s.r.l.

### Privacy:

I dati personali anagrafici e fiscali acquisiti direttamente e/o tramite terzi da Arcansas Profili s.r.l (Località Cerbara, 61030 Terre Roveresche PU), titolare del trattamento, vengono utilizzati per esigenze contrattuali e di legge, nonché per consentire un'efficace gestione dei rapporti commerciali. Tali dati potranno essere comunicati in Italia e/o all'estero alla rete di agenti Arcansas Profili s.r.l, società di factoring, istituti di credito, società di recupero crediti, società di assicurazione del credito, società di informazioni commerciali, professionisti e consulenti, trasportatori.

### Foro competente:

Per eventuali controversie derivanti dalle condizioni commerciali e/o dagli ordini ad essa connessi, sarà esclusivamente competente il tribunale di Pesaro.

## BUSINESS TERMS

### Orders, payments, and deliveries:

1. Unless otherwise indicated, all quantities on orders are rounded to the quantity per agreement of this price list: otherwise, a 10% increase in the list price will be applied. The increase will be 20% if the required quantities are less than 10 items. (Example of rounding: from 11 to 14 rounding to 10, from 15 to 19 rounding to 20)
2. Payments: first delivery, cash on delivery.
3. Supplies with amounts less than €100.00 net of discounts will not be processed.
4. All orders received before 11:00 am will be processed within 24 hours.
5. For deliveries by appointment, check with the order feasibility and surcharge office.
6. For transport costs, consult the sales department of reference.

### Other expenses:

1. FOB designated port for invoice amounts over €250.00.
  2. For Invoice amounts lower than €250.00, €15.00 will be charged for administrative expenses.
- Transportation risks: The goods travel at the buyer's risk, even if in an FOB designated port.

## GENERAL CONDITIONS

### Designs and descriptive documents:

All the Photographs, designs, and technical data of the products in the catalogue are informative and illustrative, and so therefore not binding.

### Modifications:

Arcansas Profili s.r.l reserves the right to make changes to its own products, packaging, and anything else without notice.

### Complaints:

Claims for apparent defects (e.g. missing parts or damage) must be presented to the courier directly upon receipt of the goods and also promptly to Arcansas Profili s.r.l, by means of a written reservation on the delivery note specifying the type of anomaly, under penalty of forfeiture of any warranty claims and compensation claims. Claims for defects that cannot be identified with a thorough check upon receipt of the goods (hidden defects) must be notified, under penalty of forfeiture, to Arcansas Profili s.r.l by registered letter with return receipt within seven days from the discovery of the defect and no later than 12 months from delivery. Any complaints will not entitle the purchaser to suspend or delay payments due to Arcansas Profili s.r.l.

### Warranty and defects:

Arcansas Profili s.r.l undertakes to replace products that present defects, lack of quality or lack of conformity attributable to it, which occurred within twelve months of delivery of the products, provided they have been promptly presented in the manner previously reported. Arcansas Profili s.r.l does not guarantee the compliance of the products with particular specifications or technical characteristics or their suitability for particular uses, except to the extent that these characteristics have been expressly agreed in the contract. In the event of apparent and/or hidden defects recognised by Arcansas Profili s.r.l, the purchaser is only entitled to the replacement of the product, which will be accepted as a return only in original, intact, and complete packaging. No product may be replaced without prior written authorisation from Arcansas Profili s.r.l. This warranty replaces the warranties and responsibilities provided for by law and excludes any other liability of Arcansas Profili s.r.l originating from the products sold, except in cases of willful misconduct and gross negligence.

### Retention of title:

The products remain the property of Arcansas Profili s.r.l until their full payment by the purchaser. Failure to pay, even partial, entitles Arcansas Profili s.r.l to recover the delivered goods, even if they are on deposit with third parties.

### Industrial and intellectual property:

Distinctive signs, photographs of Arcansas Profili s.r.l products and/or production and business technologies must not be used or disclosed without the prior written permission of Arcansas Profili s.r.l.

### Privacy:

The personal and tax data acquired directly and/or through third parties from Arcansas Profili s.r.l (Località Cerbara, 61030 Terre Roveresche PU), the data controller, are used for contractual and legal requirements, as well as to allow effective management of business relationships. Such data may be communicated in Italy and/or abroad to the network of Arcansas Profili s.r.l agents, factoring companies, credit institutions, debt collection companies, credit insurance companies, business information companies, professionals and consultants, transporters.

### Jurisdiction:

For any disputes arising from the business conditions and/or from the orders connected to it, the Pesaro court will have exclusive jurisdiction.

## CONDITIONS COMMERCIALES

### Commandes, paiements et délais de livraison :

1. Sauf indication contraire, toutes les quantités en commande sont arrondies à la quantité par convention de cette liste de prix, sinon une majoration du prix de liste de 10 % sera appliquée.

L'augmentation sera de 20 % si les quantités requises sont inférieures à 10 pièces. (Exemple d'arrondi : de 11 à 14 arrondis à 10, de 15 à 19 arrondis à 20)

2. Paiements : première livraison, contre remboursement.

3. Les livraisons d'un montant inférieur à 100,00 € net de remises ne seront pas traitées.

4. Toutes les commandes reçues avant 11h00 seront traitées dans les 24 heures.

5. Pour les livraisons sur rendez-vous, vérifiez auprès du bureau de commande de faisabilité et en supplément.

6. Pour les frais de port, consultez le bureau commercial de référence.

### Frais divers :

1. Frais de ports offerts pour les montants de facture supérieurs à 250,00 €.

2. Pour les montants de facture inférieurs à 250,00 €, 15,00 € de frais administratifs seront facturés.

Risques liés au transport : les marchandises circulent aux risques et périls de l'acheteur, même si les frais de port sont offerts.

## CONDITIONS GÉNÉRALES

Dessins et documents descriptifs :

Toutes les photographies, dessins et données techniques des produits du catalogue sont à titre informatif et illustratif, donc non contraignants.

### Modifications :

Arcansas Profili s.r.l se réserve le droit d'apporter des modifications à ses propres produits, emballages et toute autre chose sans préavis.

### Réclamations :

Les réclamations pour vices ou défauts apparents (par exemple, manque ou dommage) doivent être présentées au transporteur directement à la réception de la marchandise et également dans les meilleurs délais à Arcansas Profili s.r.l, au moyen d'une réserve écrite sur le bon de livraison précisant le type d'anomalie, sous peine de déchéance de tout droit de garantie et de réparation.

Les réclamations pour vices ou défauts qui ne peuvent être identifiés avec un contrôle diligent à la réception de la marchandise (vices ou défauts cachés) doivent être notifiées, sous peine de déchéance, à Arcansas Profili s.r.l par lettre recommandée avec accusé de réception dans les sept jours à compter de la découverte du vice ou du défaut, cependant, au plus tard 12 mois après la livraison.

Toute réclamation ne donnera pas le droit à l'acheteur de suspendre ou de retarder les paiements dus à Arcansas Profili s.r.l.

### Garantie et défauts :

Arcansas Profili s.r.l s'engage à remplacer les produits présentant des dommages, des défauts de qualité ou des défauts de conformité qui lui sont imputables, survenus dans les douze mois suivant la livraison des produits, à condition qu'ils aient été présentés dans les meilleurs délais de la manière précédemment signalée.

Arcansas Profili s.r.l ne garantit pas la conformité des produits à des spécifications ou caractéristiques techniques particulières ou leur adéquation à des usages et/ou usages particuliers, sauf dans la mesure où ces caractéristiques ont été expressément convenues dans le contrat.

Si des défauts apparents et/ou cachés sont décelés par Arcansas Profili s.r.l, l'acheteur n'a droit qu'au remplacement du produit, qui ne sera accepté en retour que dans son emballage d'origine, intact et complet.

Aucun produit ne peut être remplacé sans l'autorisation écrite préalable d'Arcansas Profili s.r.l.

Cette garantie remplace les garanties et responsabilités prévues par la loi et exclut toute autre responsabilité d'Arcansas Profili s.r.l provenant des produits vendus, sauf en cas de faute intentionnelle et de négligence grave.

### Réserve de propriété :

Les produits restent la propriété d'Arcansas Profili s.r.l jusqu'à leur paiement intégral par l'acheteur.

Le défaut de paiement, même partiel, autorise Arcansas Profili s.r.l à récupérer les marchandises livrées, même si elles sont en dépôt auprès de tiers.

### Propriété industrielle et intellectuelle :

Les signes distinctifs, photographies des produits Arcansas Profili s.r.l et/ou technologies de production et commerciales ne doivent pas être utilisés ou divulgués sans l'autorisation écrite préalable d'Arcansas Profili s.r.l.

### Confidentialité :

Les données personnelles et fiscales personnelles acquises directement et/ou par l'intermédiaire de tiers auprès d'Arcansas Profili s.r.l (Località Cerbara, 61030 Terre Roveresche PU), responsable du traitement, sont utilisées pour les exigences contractuelles et légales, ainsi que pour permettre une gestion efficace des relations commerciales.

Ces données peuvent être communiquées en Italie et/ou à l'étranger au réseau d'agents Arcansas Profili s.r.l, aux sociétés d'affacturage, aux établissements de crédit, aux sociétés de recouvrement de créances, aux sociétés d'assurance-crédit, aux sociétés d'informations commerciales, aux professionnels et consultants, ainsi qu'aux transporteurs

### Tribunal compétent :

Pour tout litige découlant des conditions commerciales et/ou des commandes qui y sont liées, le tribunal de Pesaro sera seul compétent.

## CONDICIONES COMERCIALES

### Pedidos, pagos y entregas:

1. A menos que se indique lo contrario, todas las cantidades de los pedidos se redondean a la cantidad por convención en esta lista de precios. De lo contrario se aplicará un aumento del 10 % sobre el precio de lista.

El aumento será del 20 % si las cantidades requeridas son inferiores a 10 piezas. (Ejemplo de redondeo: de 11 a 14 redondeo a 10, de 15 a 19 redondeo a 20)

2. Pagos: primera entrega, contrarreembolso.

3. No se procesarán los suministros con cantidades inferiores a 100 € netos de descuentos.

4. Todos los pedidos recibidos antes de las 11:00 se procesarán en un plazo de 24 horas.

5. Para entregas con cita previa, consulte con la oficina de pedidos la viabilidad y los recargos.

6. Para los costes de transporte, consulte la oficina comercial de referencia.

### Gastos varios:

1. Puerto franco para facturas superiores a 250 €.

2. Por los importes de las facturas inferiores a 250 euros se cobrarán 15 euros en concepto de gastos administrativos.

Risgos de transporte: la mercancía viaja por cuenta y riesgo del comprador, incluso en el caso de puerto franco.

## CONDICIONES GENERALES

Diseños y documentos descriptivos:

Todas las fotografías, diseños y datos técnicos de los productos del catálogo son informativos e ilustrativos, por lo que no son vinculantes.

### Modificaciones:

Arcansas Profili s.r.l se reserva el derecho de hacer cambios a sus propios productos, embalajes y cualquier otro elemento sin previo aviso.

### Reclamaciones:

Las reclamaciones por defectos o vicios aparentes (por ejemplo, falta o daños) deben presentarse al mensajero directamente al recibir la mercancía y sin demora a Arcansas Profili s.r.l mediante notificación escrita en el albarán de entrega especificando el tipo de anomalía, a cambio de la pérdida de todo derecho de garantía y de compensación.

Las quejas por defectos o vicios no detectables con un control diligente al recibir la mercancía (defectos o vicios ocultos), deben notificarse, so pena de caducidad, a Arcansas Profili s.r.l por carta certificada con acuse de recibo en un plazo de siete días a partir del descubrimiento del defecto o vicio y, en cualquier caso, en un plazo máximo de 12 meses a partir de la entrega.

Cualquier queja no dará derecho al comprador a suspender o retrasar los pagos debidos a Arcansas Profili s.r.l.

### Garantía y defectos:

Arcansas Profili s.r.l se compromete a sustituir los productos que presenten defectos, falta de calidad o falta de conformidad que le sean imputables, que se hayan producido dentro de los doce meses siguientes a la entrega de los productos, siempre y cuando se hayan presentado sin demora en la forma anteriormente comunicada.

Arcansas Profili s.r.l no garantiza la conformidad de los productos con especificaciones o características técnicas particulares o su idoneidad para usos y/o usos particulares, salvo en la medida en que dichas características hayan sido expresamente acordadas en el contrato.

En caso de defectos aparentes y/u ocultos reconocidos por Arcansas Profili s.r.l, el comprador tiene el derecho exclusivo a la sustitución del producto, que se aceptará a cambio únicamente en el embalaje original, intacto y completo.

Ningún producto se podrá reemplazar sin una autorización previa por escrito de Arcansas Profili s.r.l.

Esta garantía sustituye a las garantías y responsabilidades previstas por la ley y excluye cualquier otra responsabilidad de

Arcansas Profili s.r.l en cualquier caso que se derive de los productos vendidos, excepto en caso de intención y negligencia grave.

### Reserva de propiedad:

Los productos son propiedad de Arcansas Profili s.r.l hasta que el comprador los pague en su totalidad.

El impago, aunque sea parcial, da a Arcansas Profili s.r.l el derecho de recuperar los bienes suministrados, aunque estén almacenados con terceros.

### Propiedad industrial e intelectual:

Los signos distintivos, las fotografías de los productos de Arcansas Profili s.r.l y/o las tecnologías de producción y comerciales no se utilizarán o revelarán sin el permiso previo por escrito de Arcansas Profili s.r.l.

### Privacidad:

Los datos personales y fiscales adquiridos directamente y/o a través de terceros por Arcansas Profili s.r.l (Località Cerbara, 61030 Terre Roveresche PU), el controlador de datos, se utilizan para los requisitos contractuales y legales, así como para permitir una gestión eficaz de las relaciones comerciales.

Dichos datos se podrán comunicar en Italia y/o en el extranjero a la red de agentes de Arcansas Profili s.r.l, empresas de factoring, instituciones de crédito, empresas de cobro de deudas, compañías de seguros de crédito, empresas de información comercial, profesionales y consultores, transportistas.

### Jurisdicción competente:

Para cualquier controversia que surja en relación con las condiciones comerciales y/o las órdenes conexas, el tribunal de Pesaro tendrá jurisdicción exclusiva.

















**ARCANSAS Profili s.r.l.**

Via Cerbara, s.n. - località Piagge 61038 Terre Roveresche (PU) - ITALY  
tel. +39 0721 891989 | fax +39 0721 891980 | mail [info@arcansas.it](mailto:info@arcansas.it)

[www.arcansas.it](http://www.arcansas.it)



Arcansas Profili s.r.l.