

profili per fai da te / ceramica / suolo / sanitario

profili per suolo

**PROFILI
PER PAVIMENTO**

*Flooring profiles
Profilés de sol
Perfiles de suelo*

p. 18

Coprigiunti <i>Covers Couvre- joints Tapas de juntas</i>	p. 21
Terminali <i>Sloped cover strips Terminaisons Terminales</i>	p. 63
Giunti decorativi <i>Deco trimps Joints décoratifs Juntas decorativas</i>	p. 91
Paragradini <i>Stair Edges nez de marche Nariz de escalera</i>	p. 115
Nastro antisdrucchiolo <i>Slip Adhesive Tape Antidérapant Cinta Adhesiva Antideslizante</i>	p. 137
Giunti di dilatazione <i>Expansion joints Joints de dilatation Juntas de expansión</i>	p. 141
Laminati e Parquet <i>Laminates and Parquet Stratifiés et parquet Laminadas y Parquet</i>	p. 149
Battiscopa <i>Skirtings Plinthe Rodapié</i>	p. 189
Marketing su misura <i>Customized marketing Marketing sur-mesure Marketing personalizado</i>	p. 227
Soluzioni espositive <i>Displays Présentoirs Expositores</i>	p. 233



history / progress

the character is recognized by its profile

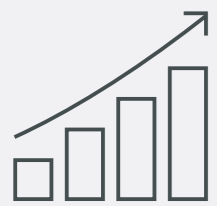

+57%

increase in turnover over the last 4 years



+179%

increase in foreign sales over the last 4 years

40 years and more. The story of an all-Italian family and company, dedicated to **tradition** and **constant research**. Because who believes in the future and valuable ideas never quits growing.

Arcansas remained over the years a **family business** despite its strong growth. We're a solid company that can define long-term business goals and freely shape our future. Since 1980 we design, produce and distribute profiles for tillings, hygienic cove, floors and hardware/do-it-yourself on the national and international market.



The story of a family



1980

Stelio Scriattoli founds **Arcansas Corporation** in Fano (Pu). A small company of 200 sq m, with **5 employees**. His dream? Commercialize on an industrial level profiles for construction and offer the market an innovative product. A winning idea thanks to which the company starts to consolidate its position and in 1984 moves to a larger site of 1000 square meters in Lucrezia (Pu).

1989/1990

Thanks to important investments in production technologies and most innovative materials available on the market, absolute innovations are presented in the profile market: **self-adhesive profiles** and profiles produced from profiling machine with **customized packaging**.

1991/1992

Stelio passes the helm of the company to his son Amedeo. The company continues to grow and in 1998 it also renews its communication with a rebranding operation: **Arcansas srl** is born.

2003/2004

It is the year of the turning point: the company opens to trade its profiles to the **large retail chains** and consolidates its market share in Italy.

1994/1995

Arcansas moves to its new 5500 sq m headquarter in Piagge (Pu). Investments in production technologies and the development of the product range continue. The **exclusive patented design of customizable display units for sales points** is introduced.

2007/2008

Arcansas becomes **leader of the large retail chains for profiles** on the Italian market. The new packaging for metal profiles is presented.

2013/2014

The third generation joins the company with Federico, Amedeo's son. **Export exceeds 30% of the turnover**. Arcansas regularly exports to over **34 countries**.

2018/2019

The Piagge plant expands and the production cycle is fully transferred to the new headquarter of Mondavio (Pu). The new **Arcansas warehouse in France** is inaugurated. The product range exceeds **5000 references**. A system for the **total traceability of products** and the **automated management of the warehouse** is introduced. New finishes for aluminum, pvc and stainless steel profiles are presented.

Future plans of the company? Manage fully the production cycle to guarantee our customers always more quality and more control on the finished product.

Amedeo Scriattoli, CEO

certifications /

protocol

the character is recognized by its profile

We offer a **quality product**, certified and guaranteed thanks to the continuous tests on outgoing products, the exclusive use of first choice materials and full respect of the REACH requirements for the safety of human health and for the environment.

Since 2009 we have obtained various national and international certifications that have allowed to optimize and further improve our processes.

OHSAS 18001:2007

Safety and workers health management

This standard allows to manage in "an organic and systematic way" the safety of the workers without upsetting the company's organisation structure, improving its performances.

Targets:

- cancel or minimize the risks/dangers associated to the staff activity
- involve and motivate the staff thanks to trainings, improved and safer working conditions
- Ensure that internal audits are carried out at scheduled intervals, of fitness, adequacy and effectiveness controls

Year of first issue: 2010 (annual renewal)

ISO 9001:2015 | Quality system

This internationally recognized standard, is the basis for the implementation of quality systems all over the world, instead of other requirements published in the past.

Targets:

- Improve credibility and image
- Improve the customer satisfaction
- Improve the processes that create value for the customer in terms of efficiency, elimination of wastefulness and minor number of errors.
- Improve decision-making
- Employees more involved and motivated to generate value

Year of first issue: 2003 (three-year renewal)



NORMS	DESCRIPTION
GENERAL REGULATIONS	
2001_95_EC	Directive General product safety
1907_2006_EC	REACH all products
SPECIFIC STANDARDS	
ISO 2813	Paints and varnishes - Determination of specular gloss of non-metallic paint films at 20 degrees, 60 degrees and 85 degrees
ISO 2360	Non-conductive coatings on non-magnetic electrically conductive basis materials
ISO 2409	Paints and varnishes- Cross-cut test
ISO 2815	Paints and varnishes-Buchholz indentation test
ISO 1520	Paints and varnishes-Cupping test
ISO 1519	Paints and varnishes-Bend test (cylindrical mandrel)
ISO 6272-1	Paints and varnishes-Rapid-deformation (impact resistance) tests-Part 1:Fallingweight
ISO 6272-2	Paints and varnishes-Rapid-deformation (impact resistance) tests-Part 2: Fallingweight
ASTM D 2794	Standard Test Method for Resistance of Organic Coatings to the Effects of Rapid
ISO 3231	Paints and varnishes--Determination of resistance to humid atmospheres containing
ISO 4628-2	Paints and varnishes--Evaluation of degradation of coatings--Designation of
ISO 9227	Corrosion tests in artificial atmospheres--Salt spray tests
ISO 16474-1 & 2	Paints and varnishes-Method of exposure to laboratory light sources-Part 1 General
ISO 11664-4	Colorimetry--Part 4: CIE 1976 L*a*b*Colour space
ISO 2810	Paints and varnishes--Natural weathering of coatings--Exposure and assessment
EN 12206-1	Paints and varnishes-Coating of aluminium and alluminium alloys for architectural
ISO 6270-2	Paints and varnishes-Determination of resistance to humidity-Part 2: Procedure for
ISO 4623-2	Paints and varnishes-Determination of resistance to filiform corrosion-Part 2 Aluminium substrates
ISO 4628-10	Paints and varnishes-Evaluation of degradation of coatings-Designation of quantity and size of defects, and of intensity of uniform changes in appearance-Part 10 Assessment of degree of filiform corrosion
ISO 10546	Chemical conversion coatings-Rinsed and non rinsed chromate conversion coatings on aluminium and aluminium alloys
ISO 3892	Conversion coatings on metallic materials--Determination of coating mass per unit area-Gravimetric methods
EN 1706	Aluminium and aluminium alloys-Castings-Chemical composition and mechanical
EN 10025	Hot rolled products of structural steels
NF EN 10162	Cold rolled steel sections-Technical delivery conditions-Dimensional and cross-sectional
EN 10305-3	Steel tubes for precision applications-Technical delivery conditions-Part 1:Seamless cold drawn
EN 10027	Designation systems for steel
EN 573	Aluminium and aluminium alloys-Chemical composition and form of wrought products
NF EN 755	Aluminium and aluminium alloys-Extruded rod/bar, tube and profiles-Part 1:technical conditions
EN 12164/12165/12166/12167/12163/1652	Copper and copper alloys
EN ISO 105-A02	Textiles. Tests for colour fastness. Part A02: grey scale for assessing change in colour
ISO 527	Plastics-Determination of tensile properties

TECHNICAL SPECIFICATIONS			
FUNCTION DESCRIPTION	NORMS	REQUEST	CONCERNED PRODUCTS
Directive General product safety	2001_95_EC	Compliance	ALL
REACH all products	1907_2006_EC	Compliance+analysis report	ALL
Substances Mixtures Articles Products Persistent Organic Pollutants POP	850 2004 EC POP	Compliance+analysis report	ALL
SAFETY		No harmful and sharp edges, cutting chips	ALL
FUNCTION DESCRIPTION	NORMS	REQUEST	CONCERNED PRODUCTS
Gloss under 60°	ISO 2813	Matt : 0-30 = > +/- 5 UG Satin : 31-70 = > +/- 7 UG Gloss : 71-100 = > +/- 10 UG	Aluminium coated profile
Coating thickness	ISO 2360/DIN 17611	Depending on coating type	All coated profile
Dry adhesion	ISO 2409	Class 0 for oxide deposition Class 1 for paint/varnish	All coated profile
Hardness-Indentation	ISO 2815	Min 80	Aluminium coated profile
Bend test	ISO 1519	No cracks	All coated profile
Impact test	ISO 6272	No cracks	All coated profile
Acetic acid salt spray (AASS)	ISO 9227	96h min	Aluminium coated profile
Appearance		Must be without scratches, impact, dust, stains, deformation	All coated profile
Colors		Conform to appearance sheet and master sample	All coated profile
Neutral salt spray (NSS)	ISO 9227	96h min	Stainless steel
Adhesives-Peel adhesion properties	NF EN 1939	To be defined	All taped profiles
Paint and varnish-Determination of resistance to abrasion	EN 7784	250 laps mini with 500g load	All coated profile

TECHNICAL SPECIFICATIONS			
FUNCTION DESCRIPTION	NORMS	REQUEST	CONCERNED PRODUCTS
STEEL not alloyed-Dimension accuracy	EN 10025	According to standard-S235JR	Steel profile
STEEL Drawn cold-Dimensions accuracy	NF EN 10162	According to standard-E235	Steel profile
STEEL PIPES welded and not welded	EN 10305-3	According to standard-S235JR	Steel profile
STAINLESS STEEL	EN 10027	According to standard-304L	Steel profile
ALUMINIUM-Composition and mechanical properties	EN 573	According to standard-Type AW 6060	Aluminium profile
ALUMINIUM PROFILES-Dimensions accuracy	NF EN 755	According to standard	Aluminium profile
BRASS ALLOY-Dimensions accuracy	EN 12164/12165/12166/12167/12163/1652	According to standard	Brass profiles
PVC-UV STABILITY	EN ISO 105-A02	According to standard-PVC	PVC profiles
PVC-Mechanical properties	ISO 527	According to standard	PVC profiles
PVC-Dimension accuracy		+/- 1%	PVC profiles



Sempre disponibile a magazzino
Always available at stock
Toujours disponibles en stock
Siempre disponibles en depósito



Protezione con pellicola
 adesiva trasparente o termoretratta per permettere la maggior conservazione del profilo contro raggi UV, polvere e graffi. Ne permette inoltre il prelievo, la manipolazione ed il trasporto senza sporcare le mani e le superfici dell'auto. Si consiglia di rimuovere dopo l'installazione.

Protective film: Remove the special adhesive which has been used to protect the profile after installation. Thanks to the protective film that Arcansas provides to its profiles, complete protection against UV rays, dust and scratches is possible. Furthermore, the protective film guarantees an ideal solution for all types of finishes. It is transparent and protects the customer from grease residues that form in the profile.

Film de protection: adhésif transparent ou thermo rétractable pour permettre une meilleure conservation du profilé contre les rayons UV, la poussière et les rayures. Il permet également le prélèvement, la manipulation et le transport sans se salir les mains et les surfaces de la voiture. Il est conseillé de le supprimer après l'installation.

Protección con película: adhesivo transparente o termorretráctil para una mejor conservación del perfil contra rayos UV, polvo y arañazos. También permite la extracción la manipulación y el transporte sin ensuciar las manos y las superficies del coche. Se recomienda quitar después de la instalación.

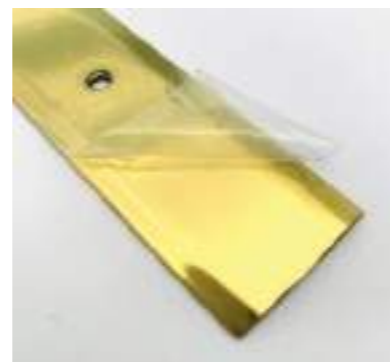
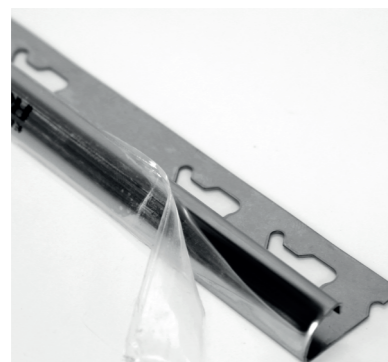

Nuovo prodotto
New product
Nouveau produit
Nuevo Producto



Supporto con foro europeo
Blister with European hole
Blister avec trou européen
Blister con agujero europeo



Disponibile su richiesta: Gli articoli contrassegnati con questo simbolo vengono forniti per quantità minime d'ordine comunicate dall'ufficio commerciale.

Available on request: Items marked with this symbol are provided if the minimum order quantities communicated by the sales department are respected.

Disponibile sur demande: Les articles marqués de ce symbole sont fournis pour des quantités minimales de commande communiquées par le bureau de vente.

Disponibile bajo petición: Los artículos marcados con este símbolo se suministran para cantidades mínimas de pedido comunicadas por la oficina comercial.



Codice EAN: a tutti i profili contrassegnati da questo simbolo viene attaccata una etichetta contenente i dati principali per la corretta e certa identificazione del prodotto. I dati indicati sono: tracciabilità completa del prodotto in normativa GS1, codice alfanumerico, descrizione del prodotto, lunghezza, materiale e finitura.

EAN code: All profiles marked with this symbol are labelled with correct data for reliable identification of the product for the customer needs. These data are: complete traceability of the product in GS1 regulation, alphanumeric code, product description, length, material and finishing.

Code EAN: tous les profilés marqués de ce symbole portent une étiquette contenant les principales données nécessaires à l'identification correcte et certaine du produit. Les données indiquées sont: traçabilité complète du produit dans la norme GS1, code alphanumérique, description du produit, longueur, matériau et finition.

Código EAN: a todos los perfiles marcados con este símbolo se adjunta una etiqueta que contiene los datos principales para la correcta y cierta identificación del producto. Los datos indicados son: trazabilidad completa del producto en normativa GS1, código alfanumérico, descripción del producto, longitud, material y acabado.

Lotto di produzione, codice EAN

Production lot, EAN code

Famiglia prodotto, codice, sezione

Product type, code, section

Materiale e misure

Material and sizes

Indirizzo produttore

Manufacturer address

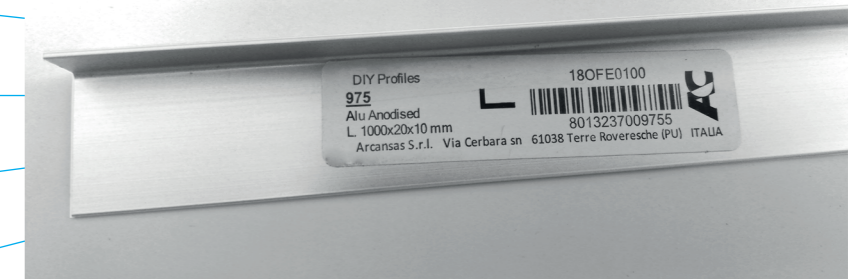

Foratura: i fori svasati permettono il perfetto alloggiamento della vite che rimane con la testa allineata al profilo. Le viti sono incluse e fornite dello stesso colore del profilo.

Holes: Screws fit perfectly with the screwhead laying flush with the surface of the profile, thanks to countersunk holes. The screws are included and supplied are the same color as the profile.

Perçage: les trous évasés permettent le logement parfait de la visse qui reste avec la tête alignée au profilé. Les visse sont inclus et fournies sont de la même couleur que le profilé.

Taladrado: los orificios avellanados permiten el alojamiento perfecto del tornillo que permanece con la cabeza alineada al perfil. Los tornillos están incluidos y suministrados son del mismo color que el perfil.

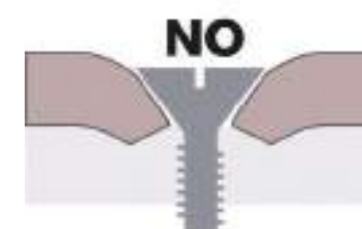
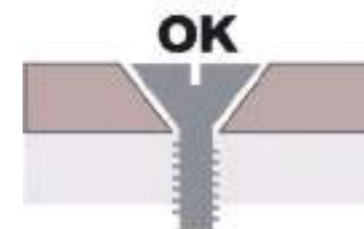



Adesivo: del tipo **Hot melt pressure sensitive** applicato a caldo (180°) direttamente sul profilo, è atossico. Può essere utilizzato a qualsiasi temperatura purchè non inferiore a 0°. Dopo l'installazione, l'adesivo diventa impermeabile all'acqua, solventi, detergenti e altri prodotti chimici. Prima dell'applicazione le superfici devono essere pulite ed esenti da grassi e polveri.

Hot melt pressure sensitive Adhesive: applied at a temperature of (180°) directly on to the profile and is non-toxic. It can also be used in lower temperatures to 0°. After installation of the profile the adhesive becomes resistant to water, solvents, detergents and other chemicals. Before application, all surfaces must be clean; free from grease and dust particles.

Adhésif: type **Hot melt pressure sensitive** appliqué à chaud (180°) directement sur le profil, il est non toxique. Il peut être utilisé à n'importe quelle température, à condition de ne pas être inférieur à 0 °C. Après l'installation, l'adhésif devient imperméable à l'eau, solvants, détergents et autres produits chimiques. Avant l'application, les surfaces doivent être propres et exemptes de matières grasses et de poussières.

Adhesivo: del tipo **Hot melt pressure sensitive** aplicado en caliente (180°) directamente sobre el perfil, es atóxico. Puede utilizarse a cualquier temperatura, siempre que no sea inferior a 0°. Tras la instalación, el adhesivo se vuelve impermeable al agua, disolventes, detergentes y otros productos químicos. Antes de su aplicación, las superficies deben estar limpias y exentas de grasa y polvo.



Adesivo: Nastro biadesivo TESA garantisce una maggior resistenza ed un'ottima durata nel tempo rispetto al pressure sensitive, le condizioni di uso possono essere verificate nella rispettiva tabella riportata di seguito.

Adhesive: TESA double-sided tape guarantees greater resistance and excellent durability over time compared to pressure sensitive, the conditions of use can be checked in the respective table below.

Adhésif: Ruban adhésif double face TESA garantit une plus grande résistance et une très bonne durée de vie par rapport à la pression sensitive, les conditions d'utilisation peuvent être vérifiées dans le tableau respectif ci-dessous.

Adhesivo: Cinta adhesiva biadhesiva TESA garantiza una mayor resistencia y una óptima duración en el tiempo respecto a las prensas sensitivas, las condiciones de uso se pueden verificar en la respectiva tabla a continuación.

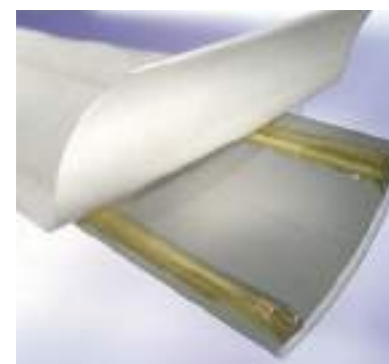

Adhesive Tape Technical Data:

Temperature resistance short term	200 °C
Temperature resistance long term	100 °C
Tack	●●●
Ageing resistance (UV)	●●●●
Humidity resistance	●●●●
Resistance to chemicals	●●●
Softener resistance	●●●
Static shear resistance at 23°C	●●●●
Static shear resistance at 40°C	●●●

●●●● very good ●●● good ●● medium ● low

MISURE

Informazioni e disegni contenuti nel presente listino hanno carattere indicativo. I dati dimensionali riportano misure nominali. Le illustrazioni fotografiche sono soggette a variazione di colorazione rispetto alla realtà dovute alla stampa.

SIZES

Information and drawings in this price list are to be considered as guideline only. Dimensional data are nominal. Colours in photographs may not correspond to the actual colours due to printing factors.

MESURES

Les informations et dessins contenus dans cette liste sont donnés à titre indicatif. Les données dimensionnelles indiquent les mesures nominales. Les illustrations photographiques sont sujettes à des variations de couleur dues à l'impression.

MEDIDAS

La información y los dibujos contenidos en esta lista tienen carácter indicativo. Los datos dimensionales incluyen medidas nominales. Las ilustraciones fotográficas están sujetas a variaciones de color con respecto a la realidad debido a la impresión.

AVVERTENZE

I profili Arcansas non necessitano di particolari manutenzioni e sono facilmente pulibili con alcool o mediante l'impiego di normali detergenti non a base acida. Si consiglia di impiegare spugne e/o panni non abrasivi per evitare di graffiare e/o danneggiare l'anodizzazione, la brillantatura, la verniciatura e la finitura. La resistenza agli agenti chimici dipende dal grado di aggressione e quindi è necessario assicurarsi in maniera preventiva dagli effetti dei prodotti impiegati per la pulizia, per la posa e la manutenzione. Calce, malte e adesivi per piastrelle possono provocare delle macchie sulla superficie a vista dei profili. E' quindi indispensabile pulire tali parti subito dopo la posa in opera.

IMPORTANT NOTES

Arcansas profiles do not require particular maintenance and are easily cleaned with alcohol or by using normal non-acid-based detergents. It is recommended to use non-abrasive sponges and/or cloths to avoid scratching and/or damaging the anodizing, brightening, painting and finishing. Resistance to chemical agents depends on the degree of aggression and therefore it is necessary to preventively ensure the effects of the products used for cleaning, laying and maintenance. Lime, mortar and tile adhesives can cause stains on the visible surface of the profiles. It is therefore essential to clean these parts immediately after installation.



Blisteratura: confezione termoretratta trasparente, resistente e appropriata per l'esposizione dei profili nell'espositore. Contiene istruzioni per la corretta applicazione del profilo. Nei profili blisterati forati, le vite sono incluse.

Blistering: transparent, resistant and heat-shrink packaging for appropriate display of profiles. It contains instructions for the correct application of the profile.

Plaquettes thermoformées: emballage thermorétractable transparent, résistant et approprié pour l'exposition des profilés dans le présentoir. Il contient des instructions pour l'application correcte du profil.

Blisteratura: envase termorretráctil transparente, resistente y adecuado para la exposición de los perfiles en el expositor. Contiene instrucciones para la correcta aplicación del perfil.

Applicazione profilo

Profile application

Materiale e sezione

Material and section

Sistema di fissaggio

Fixing system

Codici e misure

Codes and sizes

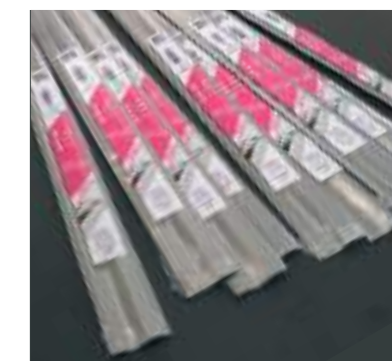
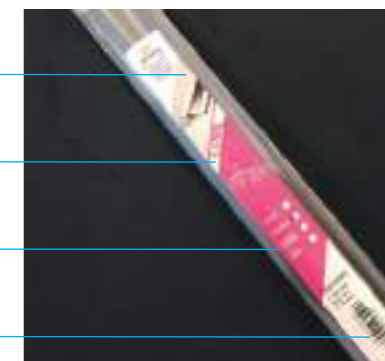

Antidrucciolo applicato.
Non-slip tape applied.
Antidérapant appliqué.
Antideslizante aplicado.



Antidrucciolo non applicato.
Non-slip tape not applied.
Antidérapant non appliqué.
Antideslizante no aplicado.



Nuovo gancio
New hook
Nouveau crochet
Nuevo gancho

Tutti i codici arcansas che presentano /GA sono dotati di nuovo gancio



Profilo con base: Il profilo viene fornito completo di base.
Profile with base: The profile is supplied complete with base.
Profilé avec base: Le profil est fourni complet avec base.
Perfil con base: El perfil se suministra completo con base.



Profilo pellicolato color legno
Wooden effect Film-coated profile
Profilé film couleur bois
Perfil recubierto con film color madera



Punti di forza: caratteristiche specifiche e vantaggi
Strong points: efficient features and advantage in usage and aesthetical effect
Points forts: caractéristiques et avantages spécifiques
Puntos de fuerza: características y ventajas específicas



Perfect Matching: perfetto abbinamento tra finiture dei 3 cataloghi
Perfect matching: different profiles from Arcansas range with same finishing, to create harmonious settings.
Perfect Matching: correspondance parfaite entre les finitions des 3 Catalogues
Perfect Matching: combinación perfecta entre los acabados de los 3 catálogos



Articoli disponibili nel Deposito Francia.
Items available in the France warehouse.
Articles disponibles dans l'entrepôt France.
Artículos disponibles en el almacén de Francia.

AVERTISSEMENTS

Les profilés Arcansas ne nécessitent pas d'entretien particulier et sont faciles à nettoyer à l'alcool ou à l'aide de détergents normaux à base non acide. Il est recommandé d'utiliser des éponges et/ou des chiffons non abrasifs pour éviter de rayer et/ou d'endommager l'anodisation, le polissage, la peinture et la finition. La résistance aux agents chimiques dépend du degré d'agression et il est donc nécessaire de s'assurer préventivement des effets des produits utilisés pour le nettoyage, la pose et l'entretien. La chaux, les mortiers et les autocollants pour tuiles peuvent provoquer des taches sur la surface visible des profilés. Il est donc indispensable de nettoyer ces pièces immédiatement après la pose.

ADVERTENCIAS

Los perfiles Arcansas no requieren un mantenimiento especial y pueden limpiarse fácilmente con alcohol o utilizando detergentes normales sin ácido. Se recomienda utilizar esponjas y/o paños no abrasivos para evitar rayar y/o dañar la anodización, el pulido, la pintura y el acabado. La resistencia a los agentes químicos depende del grado de agresión y por lo tanto es necesario asegurarse de los efectos preventivos de los productos utilizados para la limpieza, la instalación y el mantenimiento. La cal, las maltas y los adhesivos para baldosas pueden provocar manchas en la superficie visible de los perfiles. Por lo tanto, es indispensable limpiar estas partes inmediatamente después de la colocación.

productivity

the character is recognized by its profile

We transform **aluminum, stainless steel, brass, iron and pvc** into products with strong aesthetic and technical impact thanks to a **constant research of quality** in the raw materials.

The search of the best raw materials and the **variety of finishes available** are the first steps to create an excellent product. This is why we put great attention and care in the selection and research of the materials we produce our profiles. Our wide range of finishes goes from the brushed, chromed, copper aluminum to the glossy and mat pvc. The close collaboration with our suppliers allow us to develop and research **ad hoc products** to satisfy the very different needs of each customer.

“The beauty and care in the finishes show great attention to details, which is not obvious in the production of profiles.

Quality control manager

production cycle / raw materials

Iron cutting



EXCLUSIVE FINISHES

Thanks to careful analysis and to our know how, we offer a **real alternative to standard finishes** of the profiles on the market. We've been the first ones to introduce new decorative finishes for aluminum, pvc, iron and stainless steel in the field of hardware and do-it-yourself.

Stamping, profiling and cutting line



Anodic bath

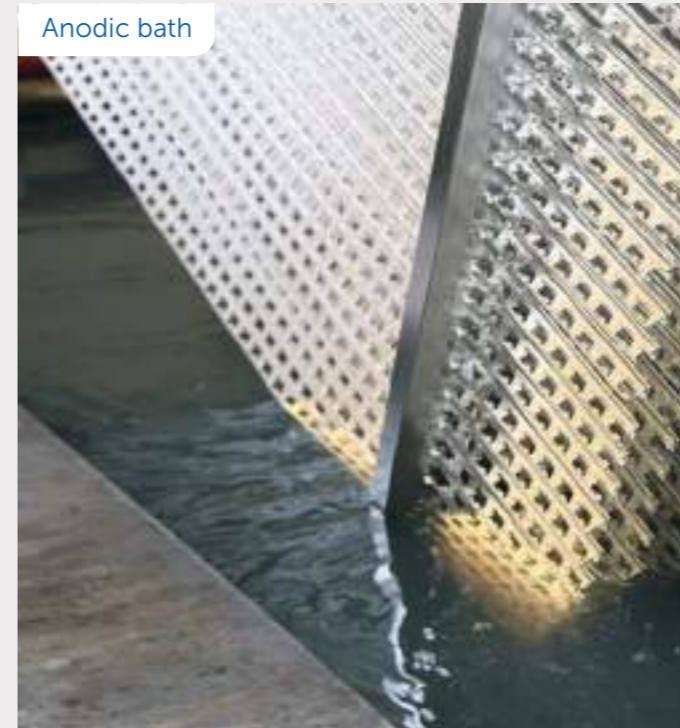

Brushing

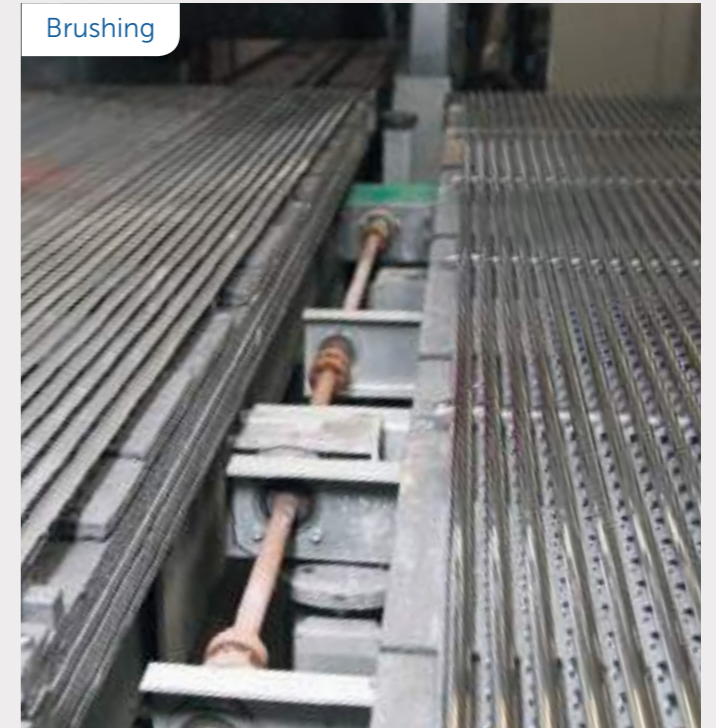

production cycle / production /

productivity

the character is recognized by its profile

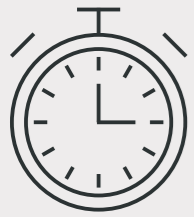

450

profiles blistered in an hour

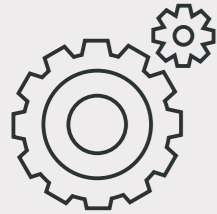

16h

one production cycle

To whom asks which is the secret recipe to produce high-level profiles we answer: **experience, the people and technology.**

We like the nice things, and we know that to create them you need not only **technologically advanced tools**, but also the passion and ability of qualified persons that can use them. We dedicate **great care in the selection and training of our staff**, always keeping an eye on technological innovation, to offer a complete product.



Bending-off press



Iron cutting line



3500 pieces produced in an hour of bending-off press

production cycle / production



Iron processing line



PVC extrusion

1800

profiles processed each hour per machine



Blister machine



Double-sided adhesive application



Boxes packaging



GUARANTEED QUALITY

The **control of the production process** and the traceability are our absolute priorities. All the raw materials are controlled upon entrance and are monitored in each processing stage. We carry out

pre-established sample checks on all products through the use of **certified tools** and with the direct co-operation of specialized laboratories in the testing of materials and finishes.

PROFILI PER PAVIMENTO

Flooring profiles
Perfilés de sol
Perfiles de suelo





Perfect Matching

Catalogo Profili fai da te / DIY Catalogue

Catalogo Ceramica / Ceramic catalogue

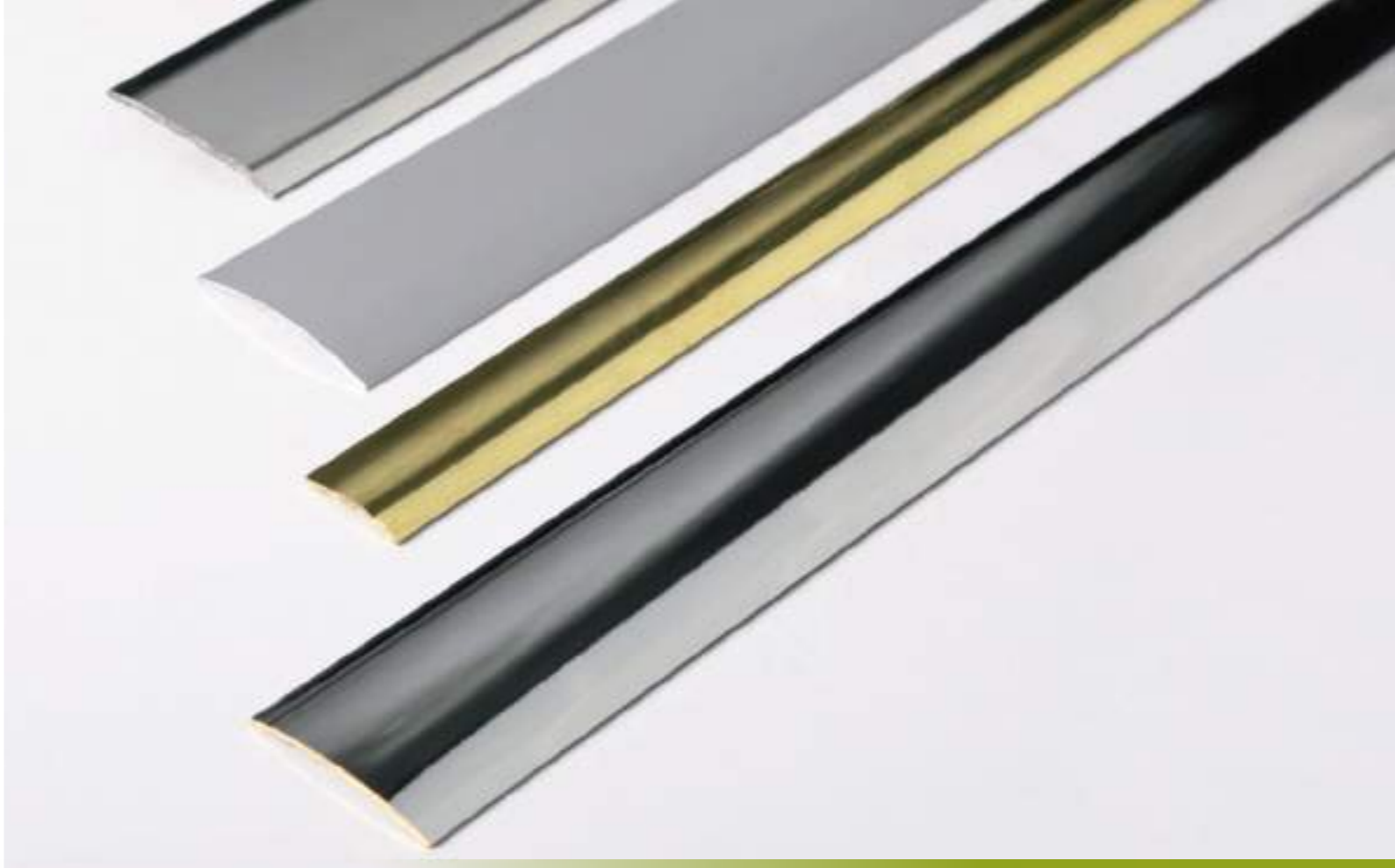

Coprigiunti Covers/ Couvre-joints/Tapas de juntas

I Coprigiunti Arcansas sono una linea di profili progettata per coprire in modo elegante eventuali imperfezioni del pavimento, dovute al taglio o alla posa fra pavimenti di differenti materiali come ceramica, parquet o moquette. Offerti in differenti materiali e finiture, sono realizzati in versione raccordata o planare. La vasta gamma è abbinabile alle finiture dei profili per il rivestimento. La diversità dei materiali impiegati, rendono tali profili utilizzabili sia in ambito civile che pubblico. Finiture disponibili: Acciaio inox Aisi 304, ottone, alluminio, pvc

Vantaggi:

- Altamente decorativi
- Resistenti al calpestio
- Resistenza ai graffi
- La loro applicazione consente l'utilizzo di diversi pavimenti
- Facilità di applicazione (con viti o colla/adesivo)
- Scarsa manutenzione
- Abbinabili alla gamma di profili per rivestimento e profili fai da te
- Ampia gamma di colori

Arcansas' wide range of covering profiles is specifically designed to create a pleasing result to fix flooring imperfections due to the cuttings and the installations of different kind of floorings such as tiles, parquet or moquette. The best solution comes not only from the aesthetic design given by the joint function, but it is also conceived for a smooth passage thanks to the planar-shape. All finishing can be matched with the finishings of the rest of covering profiles. Arcansas proposes different materials to give flexibility in usage: these profiles can be used in both public and private settings. Available finishings: AISI 304 Stainless-steel, brass, aluminium and PVC

Strong points:

- Highly decorative
- Resistant to foot traffic and scratches
- Applicable to different kind of floorings
- Easy application thanks to screws or glue/adhesive tape
- Little maintenance is required
- Can be matched with covering profiles and DIY profiles
- Wide range of colours

Les couvre-joints Arcansas sont une gamme de profilés conçus pour couvrir avec élégance les imperfections du sol, dues à la coupe ou à l'installation entre les sols de différents matériaux tels que la céramique, le parquet ou la moquette. Proposés en différents matériaux et finitions, ils sont réalisés en version articulée ou plate. La large gamme peut être combinée avec les finitions des profilés de revêtement. La diversité des matériaux utilisés rend ces profilés utilisables à la fois dans des contextes civils et publics. Finitions disponibles: acier inoxydable Aisi 304, laiton, aluminium, PVC





Avantages:

- Très décoratif
- Résistant au piétinement
- Résistance aux rayures
- Leur application permet l'utilisation de différents sols
- Facile à appliquer (avec vis ou colle/adhésif)
- Faible entretien
- Peut être combiné avec la gamme de profilés de revêtement et de profilés de bricolage
- Large gamme de couleur

Los tapajuntas Arcansas son una línea de perfiles diseñados para cubrir con elegancia cualquier imperfección en el suelo debido al corte o instalación entre suelos de diferentes materiales como cerámica, parquet o moqueta. Ofrecidos en diferentes materiales y acabados, se realizan en versión curva o plana. La amplia gama se puede combinar con los acabados de los perfiles de revestimiento. La diversidad de los materiales utilizados hace que estos perfiles sean utilizables tanto en contextos residenciales como públicos. Acabados disponibles: acero inoxidable Aisi 304, latón, aluminio, PVC

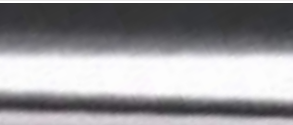
Ventajas:

- Altamente decorativo
- Resistente al tráfico peatonal
- Resistencia al rayado
- Su aplicación permite el uso de diferentes suelos
- Fácil aplicación (con tornillos o pegamento/adhesivo)
- Se necesita de poco mantenimiento
- Se puede combinar con la gama de perfiles de revestimiento y perfiles de bricolaje
- Amplia gama de colores

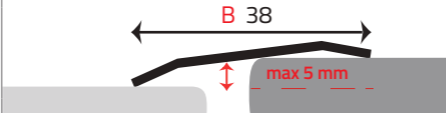
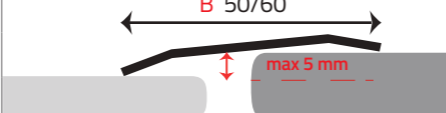
PIATTOINOX	Finitura- Finish	Range di applicazione	B. (mm)	EAN	Cod.	Caratteristiche	L. (m)	Conf. - Carton	Min. ord.		
 <p>Dimensioni: B 23/31/38/50/60</p> <p>SMOOTH TRANSITION 2,50</p>	 <p>acciaio inox lucido AISI 304 polished AISI 304 s.steel</p>	 <p>0 mm</p>  <p>B 23 max 2 mm</p>  <p>B 31 max 4 mm</p>  <p>B 38 max 5 mm</p>  <p>B 50/60 max 5 mm</p>	23	8013237006105	052B2 (FR)		2,70	10	5		
			31	8013237006341	052E (FR)		2,70	10	5		
			38	8013237006037	052A (FR)		2,70	10	5		
			38	8013237006266	052B8		2,70	10	5		
			31	8013237052515	052E1 (FR)		1,00	10	5		
			23	8013237052249	052B4 (FR)	 	0,90	10	5		
			31	8013237052522	052E2 (FR)	 	0,90	10	5		
			31	8013237005160	051F	 	0,90	10	5		
			38	8013237052218	052B1 (FR)	 	0,90	10	5		



Profilo adesivo
Adhesive profile

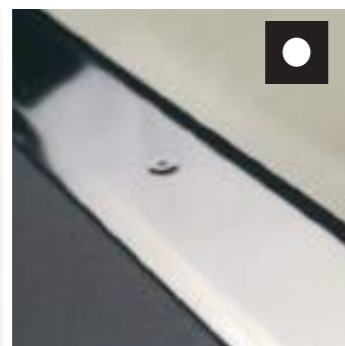

Profilo forato con viti incluse
Drilled profile with screws included







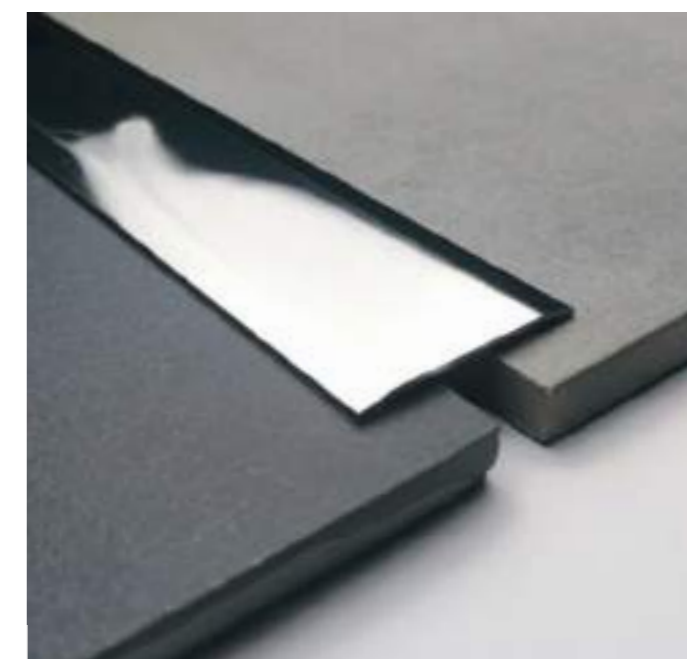
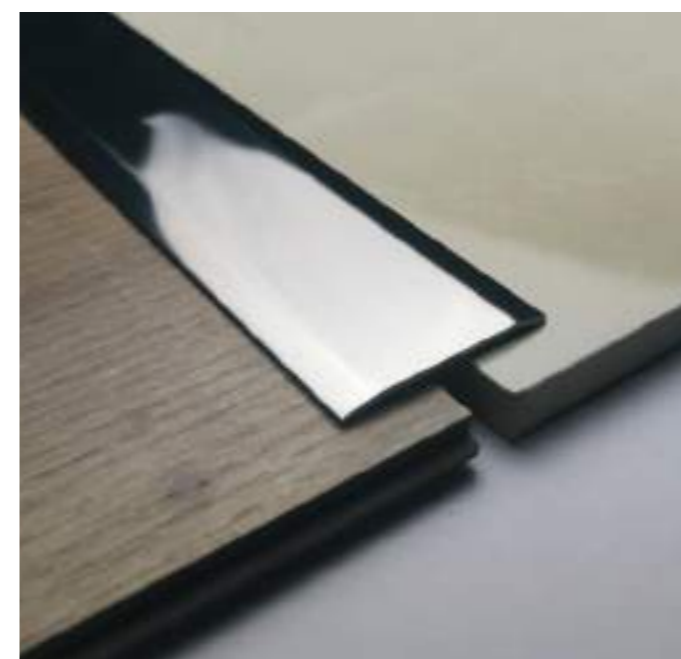

Profilo con pellicola
Profile with film

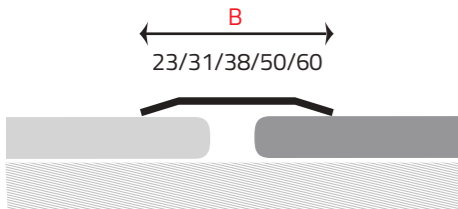

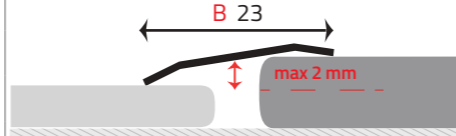
Profilo blisterato
Profile with blister

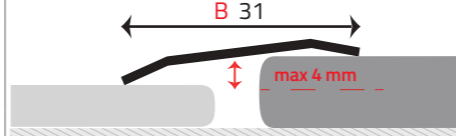

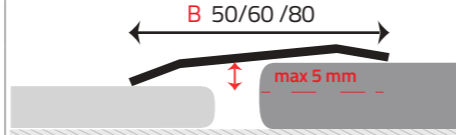
PIATTOBRASS	Finitura- Finish	Range di applicazione	B. (mm)	EAN	Cod.	Caratteristiche	L. (m)	Conf. - Carton	Min. ord.
  	 ottone lucido polished brass	 0 mm							
		 B 23 max 2 mm	23	8013237001612	016A		0,90	10	5
		 B 31 max 4 mm	31	8013237001742	017D		0,90	10	5
		 B 38 max 5 mm	38	8013237001933	019C		0,90	10	5
		 B 50/60/80 max 5 mm							

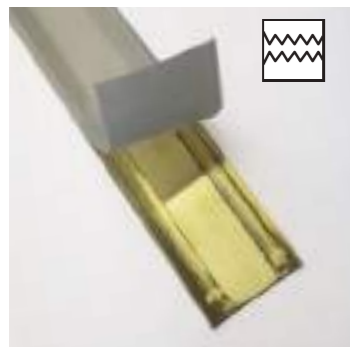

Profilo adesivo
Adhesive profile

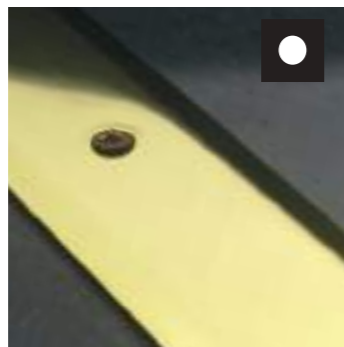

Profilo forato con viti incluse
Drilled profile with screws included

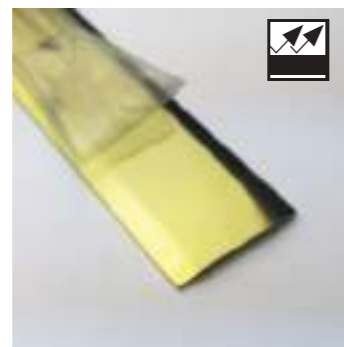







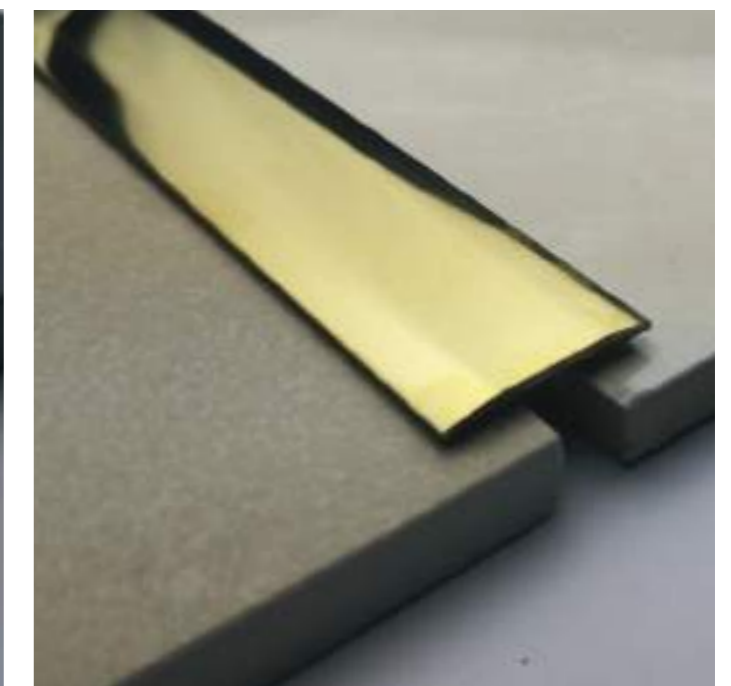
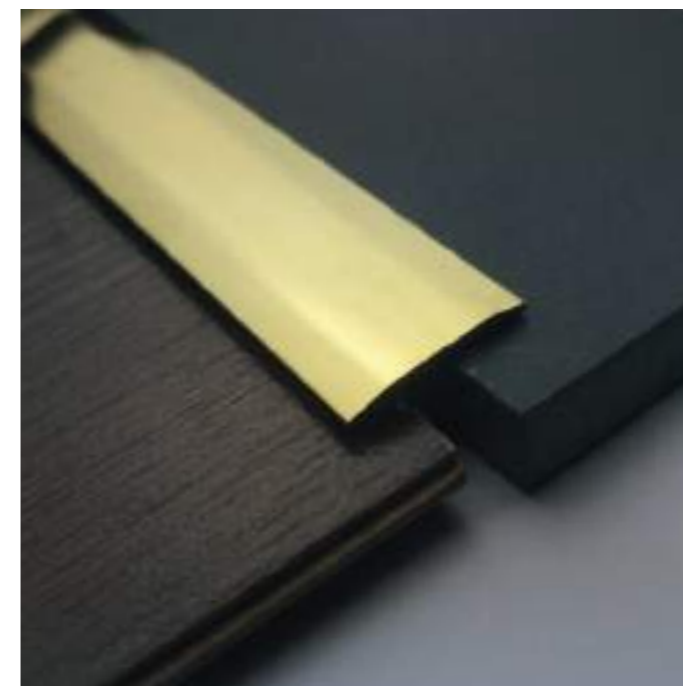

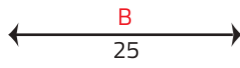
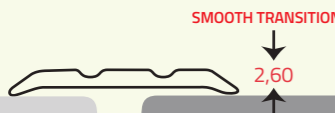



















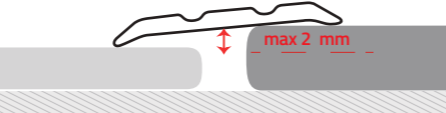



Profilo con pellicola
Profile with film

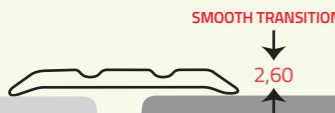

Profilo blisterato
Profile with blister



PIATTOAL	Finitura- Finish	Range di applicazione	B. (mm)	EAN	Cod.	Caratteristiche	L. (m)	Conf. - Carton	Min. ord.		
  	 argento anodizzato satinato anodised satin silver	 0 mm	25	8013237005603	046M/90 	 	2,70	10	5		
			25	8013237005658	046P/90	 	2,70	10	5		
			25	8013237060749	046P1/90	 	1,80	10	5		
			25	8013237054281	046M1/90	 	1,80	10	5		
			25	8013237046149	046N/90 	  	0,90	10	5		
			25	8013237500498	046Q/90	  	0,90	10	5		
	 oro anodizzato satinato anodised gold satin	 max 2 mm	25	8013237046125	046N/91	  	0,90	10	5		
			25	8013237005627	046M/92	 	2,70	10	5		
			 bronzo anodizzato satinato anodised satin bronze		25	8013237047214	046M/93	 	2,70	10	5
					25	8013237077488	046N/93	  	0,90	10	5

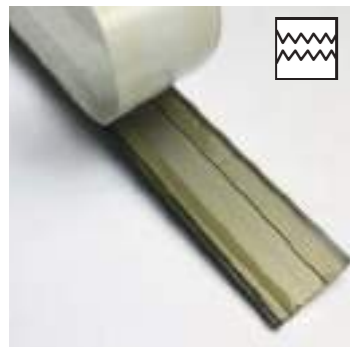

Profilo adesivo
Adhesive profile

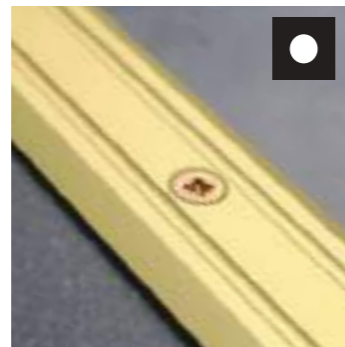







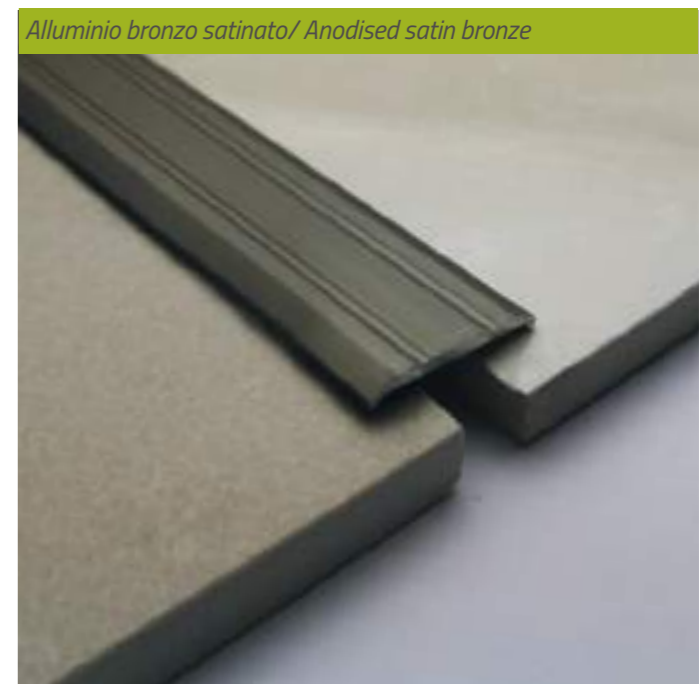
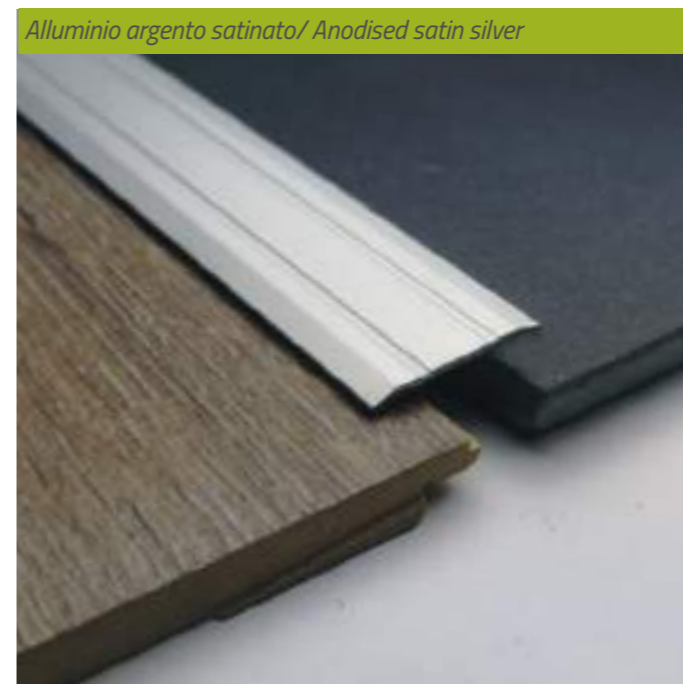

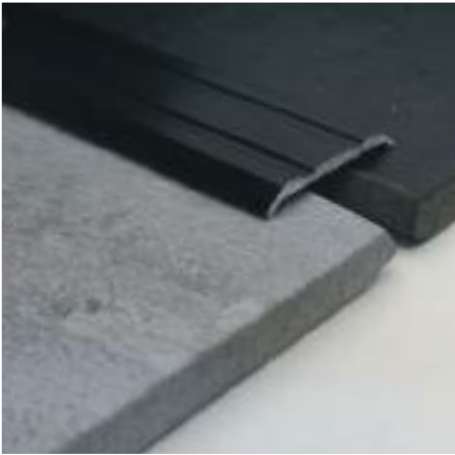

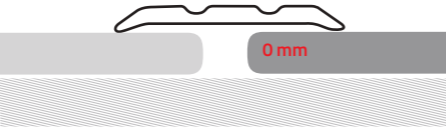



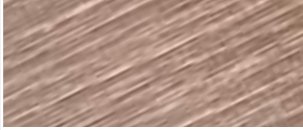
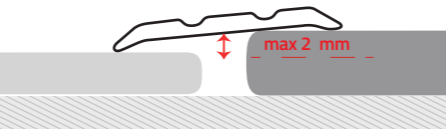

Profilo forato con viti include
Drilled profile with screws included



Profilo blisterato
Profile with blister



PIATTOAL	Finitura- Finish	Range di applicazione	B. (mm)	EAN	Cod.	Caratteristiche	L. (m)	Conf. - Carton	Min. ord.
	 nero anodizzato spazzolato brushed anodised black	 0 mm	25	8013237070939	046Q/63	 	0,90	10	5
			25	8013237070908	046N/63		 	0,90	10
	 ramato anodizzato spazzolato brushed anodised copper	 max 2 mm	25	8013237070892	046N/995	 	0,90	10	5
			25	8013237070922	046Q/995	 	0,90	10	5
	 titanio anodizzato spazzolato brushed anodised titanium		25	8013237070885	046N/96	 	0,90	10	5
			25	8013237070915	046Q/96	 	0,90	10	5

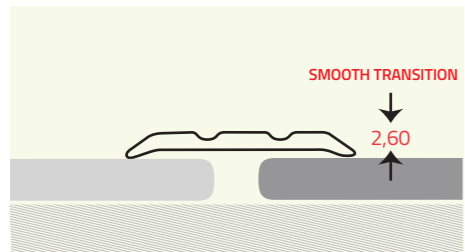
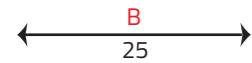

Perfect Matching

Catalogo profili fai da te / DIY catalogue

Catalogo Ceramica / Ceramic catalogue

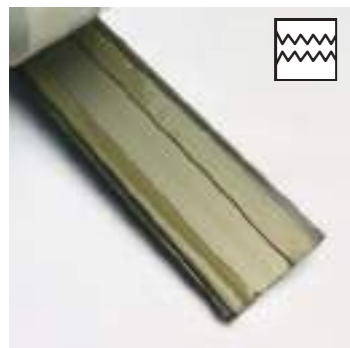

Profilo adesivo
Adhesive profile

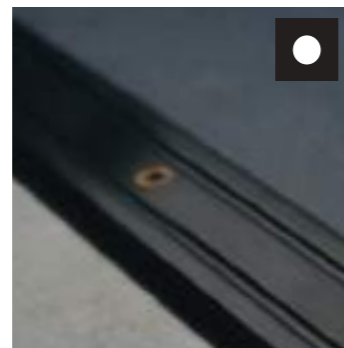

Profilo forato con viti incluse
Drilled profile with screws included



Profilo blisterato
Profile with blister

Alluminio titanio spazzolato / Brushed anodised titanium

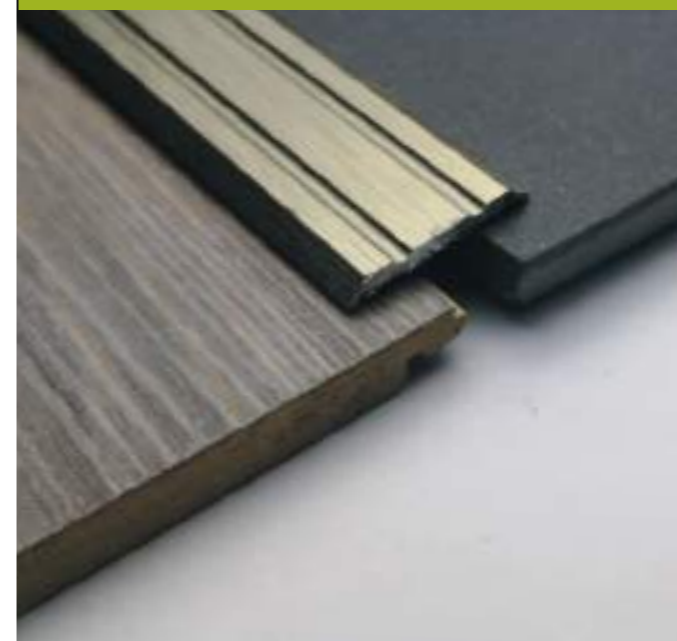

Alluminio ramato spazzolato / Brushed anodised copper

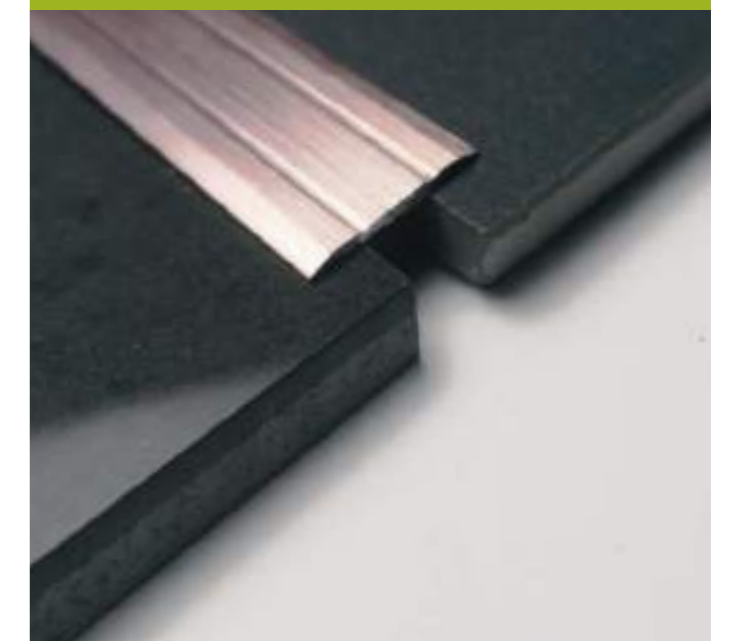

SEMIAC	Finitura- Finish	Range di applicazione	B. (mm)	EAN	Cod.	Caratteristiche	L. (m)	Conf. - Carton	Min. ord.
	acciaio inox lucido AISI 304		16	8013237053505	051M		0,90	10	5
	polished AISI 304 s.steel								

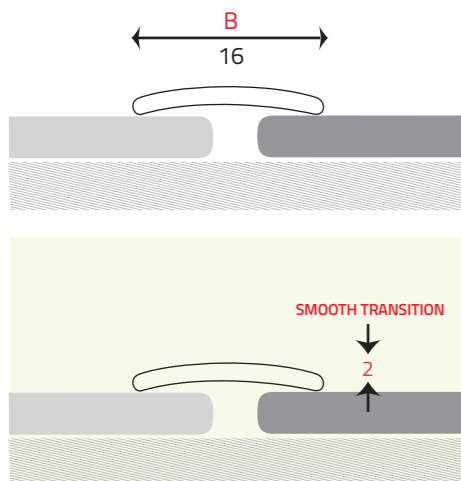

Profilo adesivo
Adhesive profile









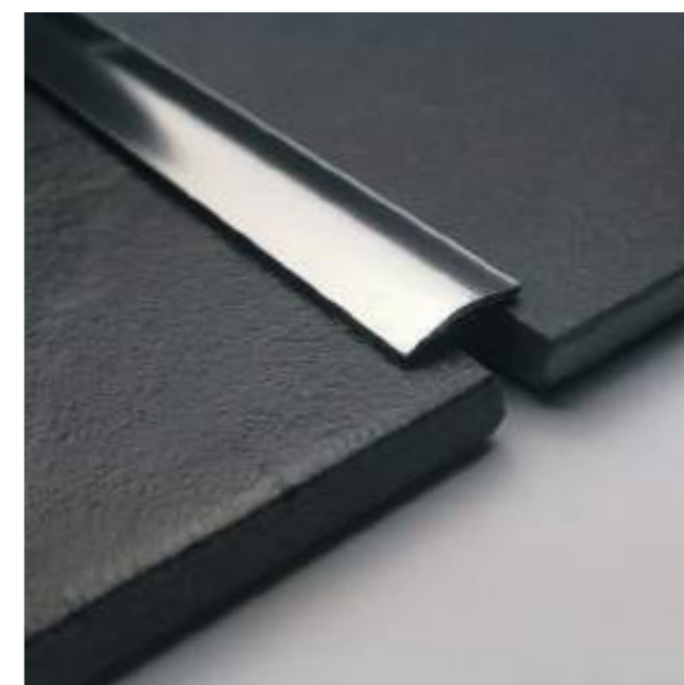
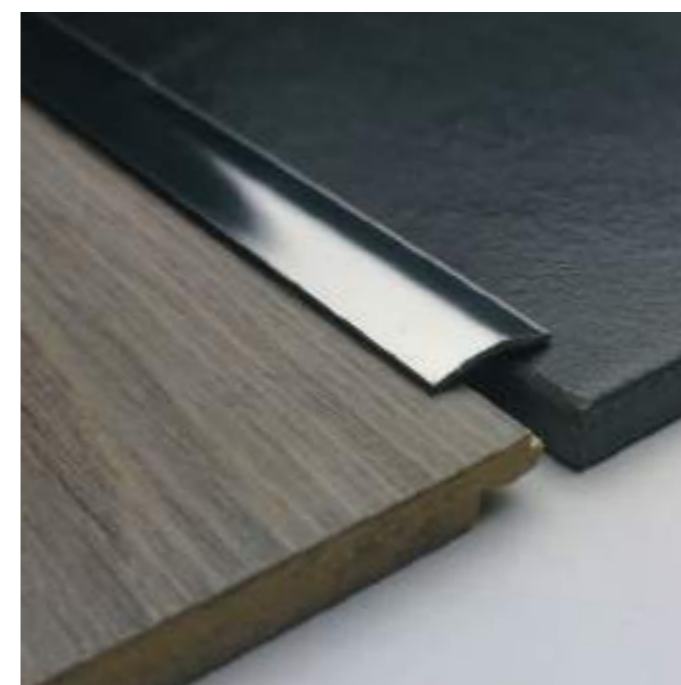

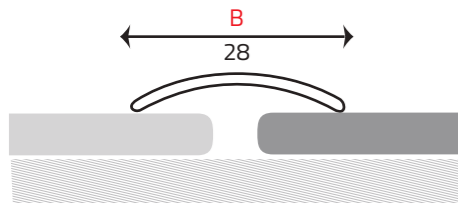
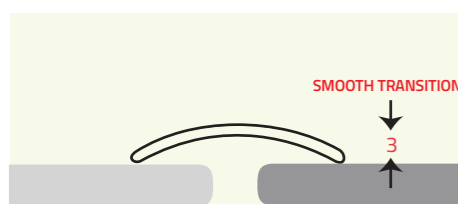
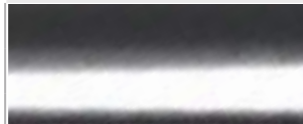



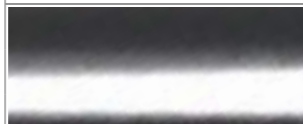





Profilo con pellicola
Profile with film



Profilo blisterato
Profile with blister



SEMITONDO	Finitura- Finish	Range di applicazione	B. (mm)	EAN	Cod.	Caratteristiche	L. (m)	Conf. - Carton	Min. ord.	
  	 acciaio inox super lucido AISI 304 high gloss AISI 304 s.steel	 0 mm	28	8013237005948	051B	 	2,70	10	5	
	 acciaio inox lucido AISI 304 polished AISI 304 s.steel	 max 3 mm	28	8013237057633	051B7	 	1,66	10	5	
				28	8013237048891	051B2 	  	0,90	10	5
				28	8013237057046	051B5	  	0,90	10	5
		 acciaio inox spazzolato AISI 304 brushed AISI 304 s.steel		28	8013237138660	051B1S	 	0,90	10	5

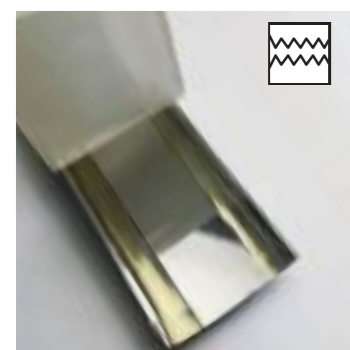

Profilo adesivo
Adhesive profile

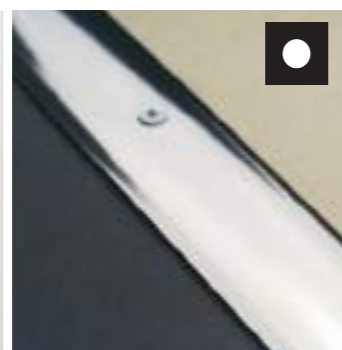

Profilo forato con viti incluse
Drilled profile with screws included



Profilo con pellicola
Profile with film



Profilo blisterato
Profile with blister

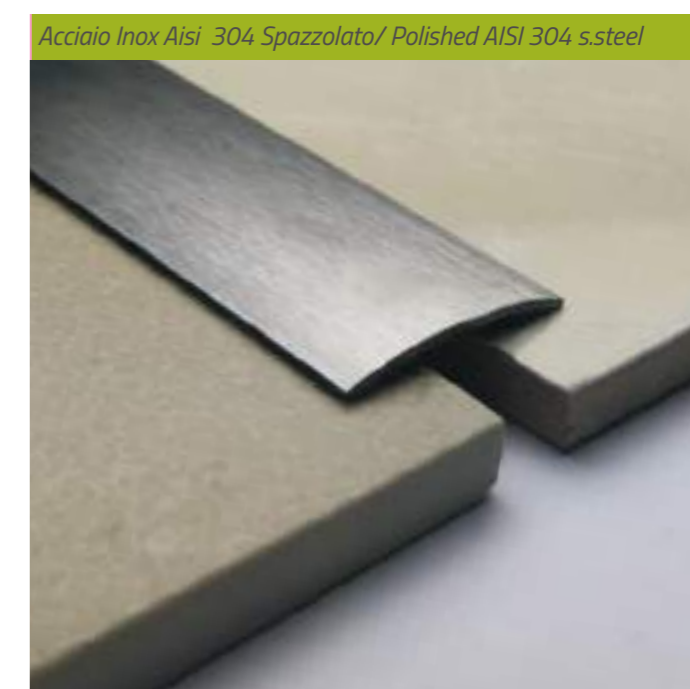

CRAFTINOX	Finitura- Finish	Range di applicazione	B. (mm)	EAN	Cod.	Caratteristiche	L. (m)	Conf. - Carton	Min. ord.
	acciaio inox lucido AISI 304 polished AISI 304 s.steel	0 mm	32	8013237500528	052		0,90	10	5
			32	8013237005139	051C		0,90	10	5
		max 4 mm							

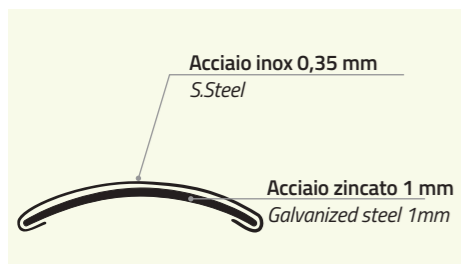
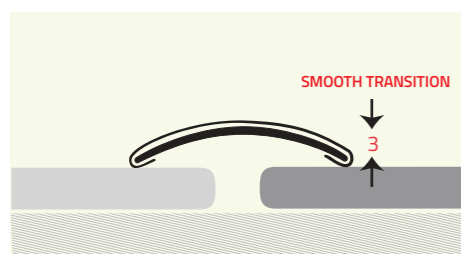
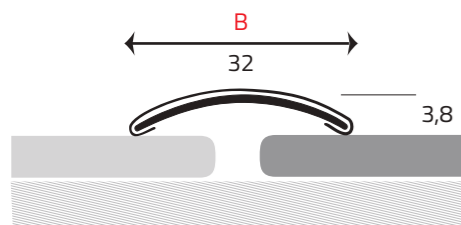

Punti di forza Strengths

Resistente, adatto a superfici ad alta intensità di passaggio

Resistant, suitable for intensive transition areas

Résistant, adapté aux surfaces de passage à haute intensité

Resistente, apto para superficies con alto flujo de personas

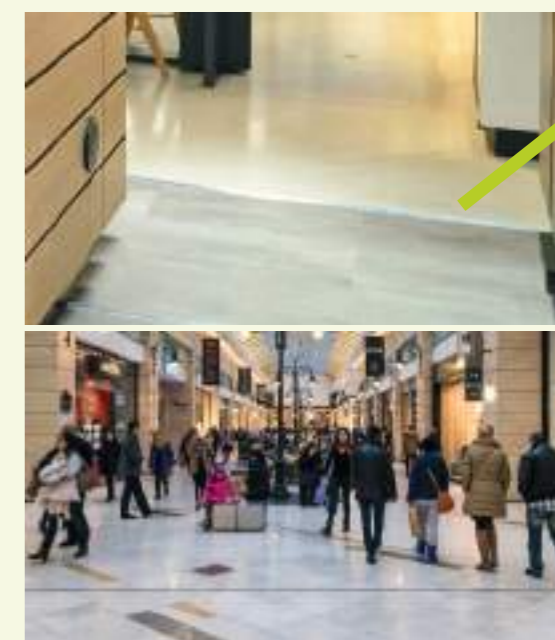

Profilo adesivo
Adhesive profile

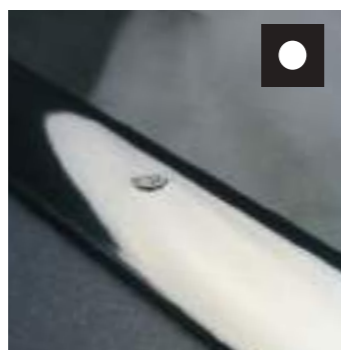

Profilo forato con viti incluse
Drilled profile with screws included











Profilo con pellicola
Profile with film

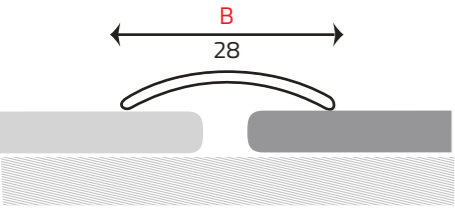
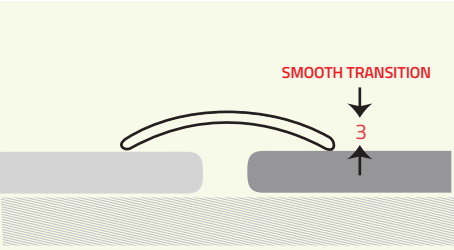

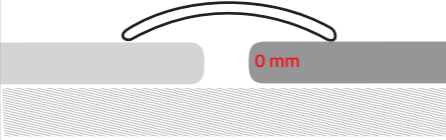
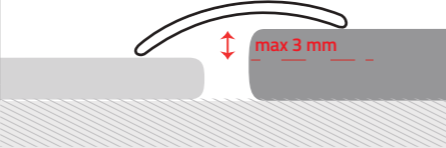
Profilo blisterato
Profile with blister





SEMIBRAS	Finitura- Finish	Range di applicazione	B. (mm)	EAN	Cod.	Caratteristiche	L. (m)	Conf. - Carton	Min. ord.	
  	 ottone lucido polished brass	 								
			28	8013237057718	006A7		1,66	10	5	
			28	8013237057725	006A8	 	0,93	10	5	
			28	8013237057732	006A9			0,93	10	5
			28	8013237006136	006A3			0,90	10	5
			28	8013237057749	006A10		0,83	10	5	

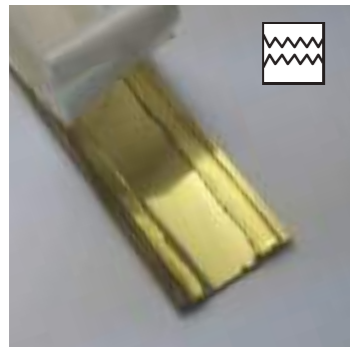

Profilo adesivo
Adhesive profile

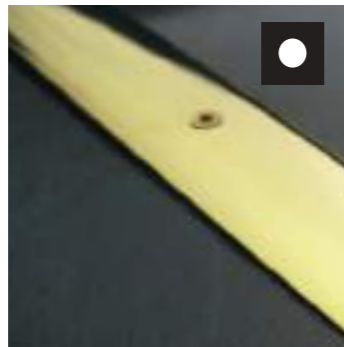

Profilo forato con viti incluse
Drilled profile with screws included

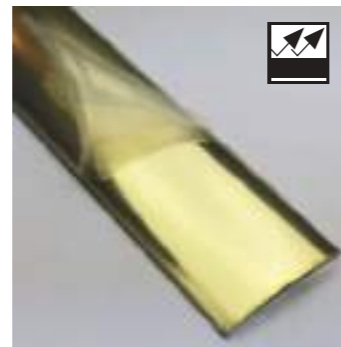







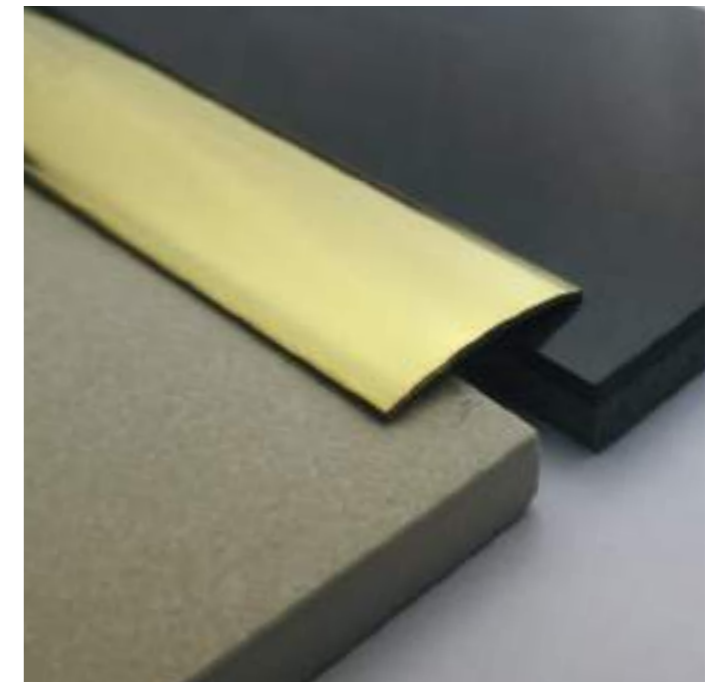
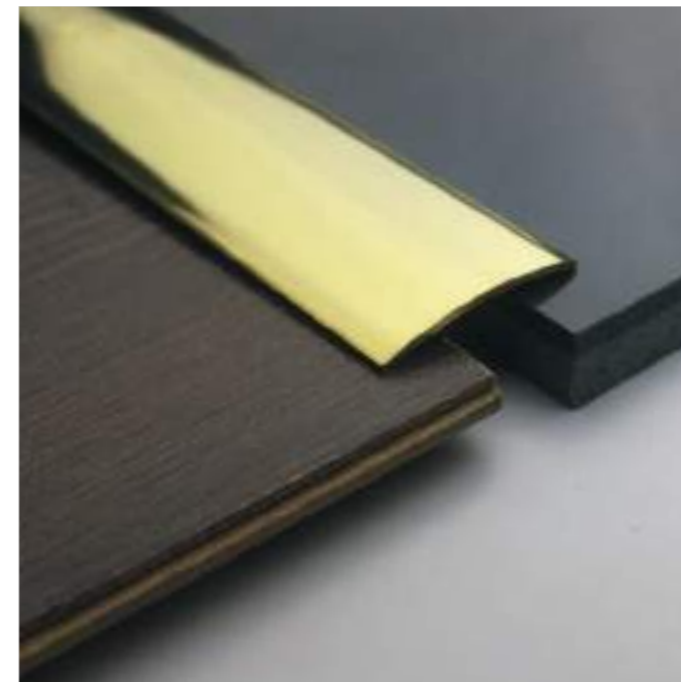



Profilo con pellicola
Profile with film



Profilo blisterato
Profile with blister



SEMIBIG	Finitura- Finish	Range di applicazione	B. (mm)	EAN	Cod.	Caratteristiche	L. (m)	Conf. - Carton	Min. ord.
	 <p>ottone lucido polished brass</p>	 <p>0 mm</p>							
			 <p>max 5 mm</p>	40	8013237006112	006K	  	0,90	10
			40	8013237006211	006K1	  	0,90	10	5

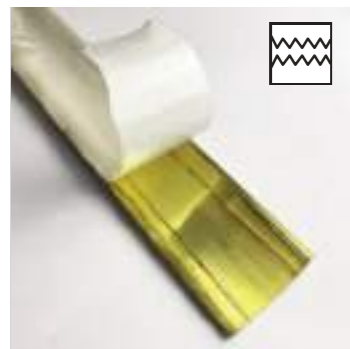
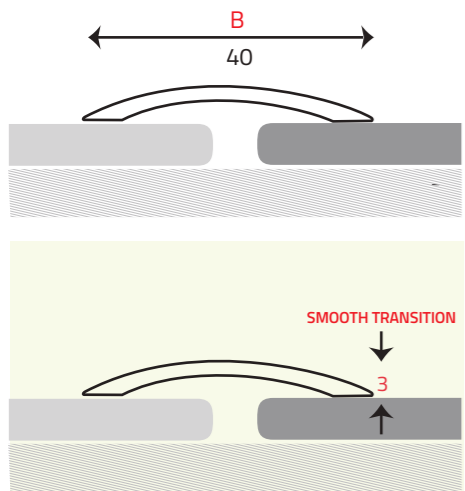

Profilo adesivo
Adhesive profile

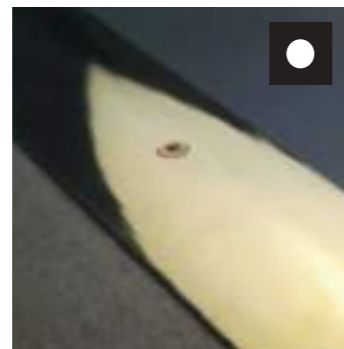

Profilo forato con viti incluse
Drilled profile with screws included



Profilo blisterato
Profile with blister

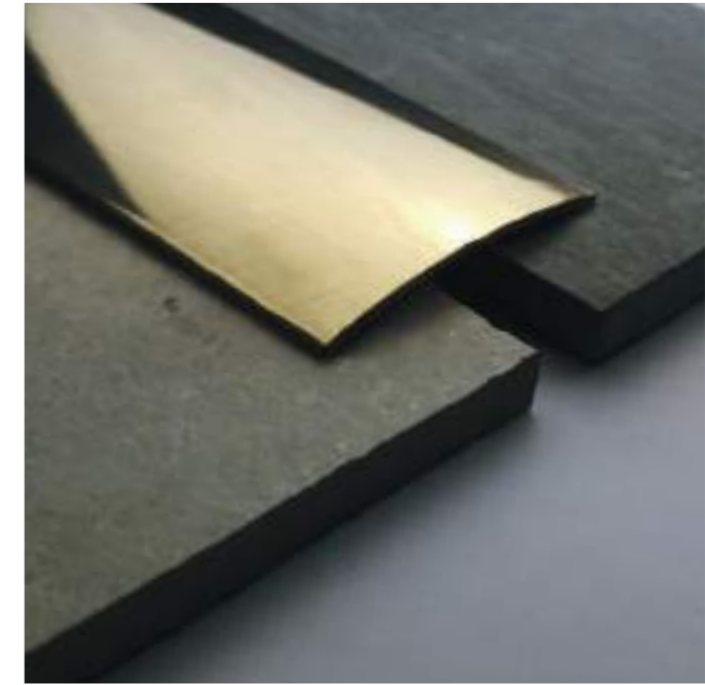
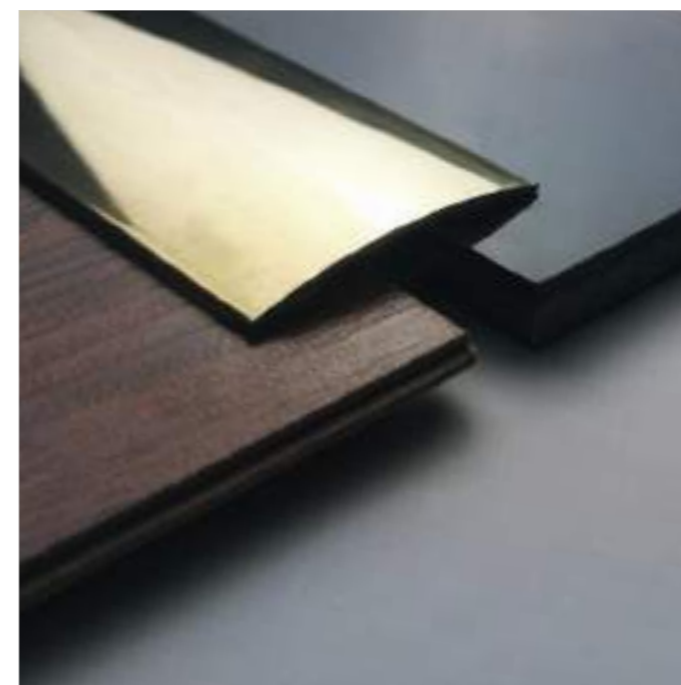

CRAFTBRAS	Finitura- Finish	Range di applicazione	B. (mm)	EAN	Cod.	Caratteristiche	L. (m)	Conf. - Carton	Min. ord.
	ottone lucido polished brass		32	8013237000059	005		1,00	10	5
			32	8013237000066	006		0,90	10	5

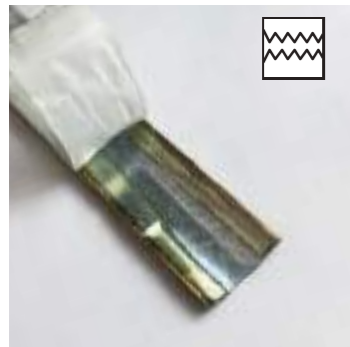
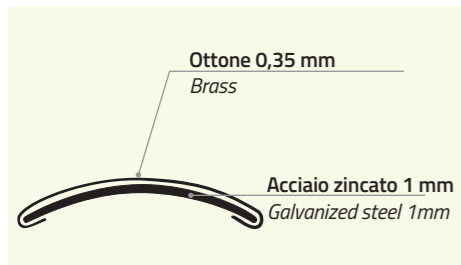
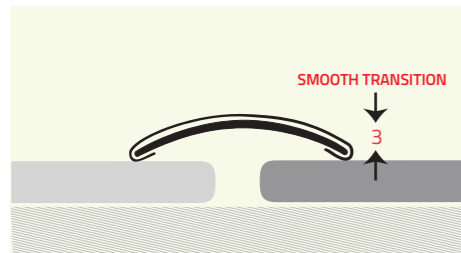
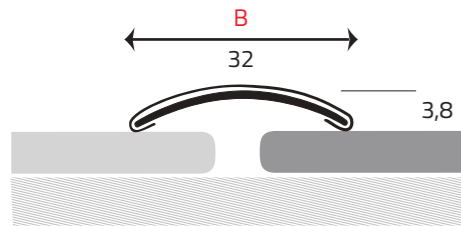

Profilo adesivo
Adhesive profile

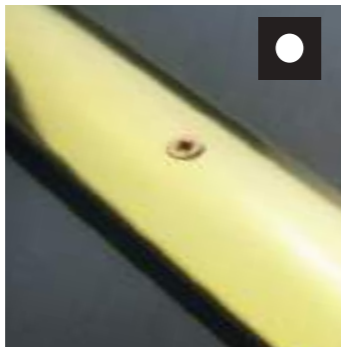

Profilo forato con viti incluse
Drilled profile with screws included

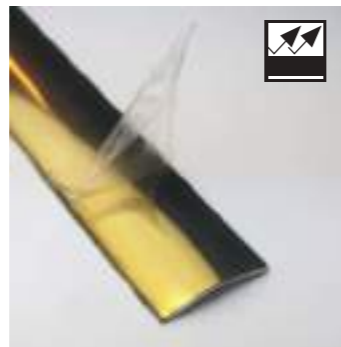

Profilo con pellicola
Profile with film



Profilo blisterato
Profile with blister

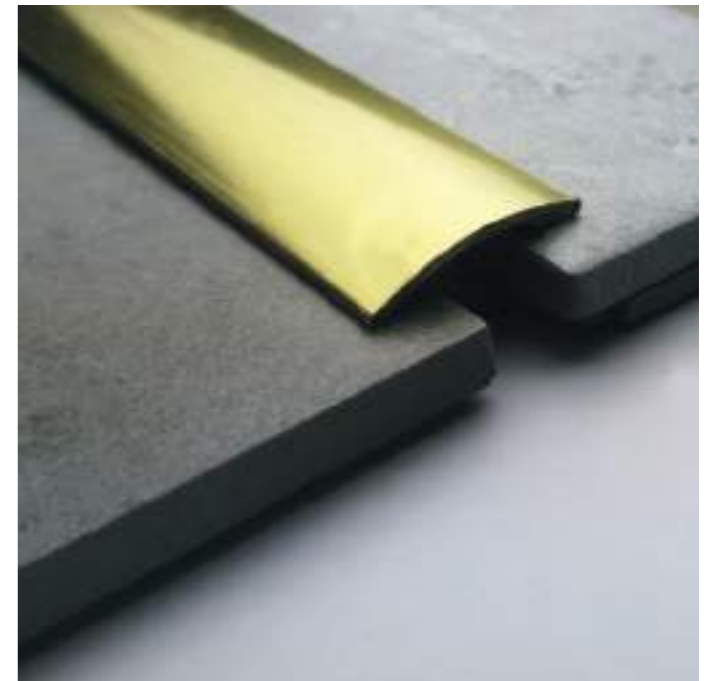
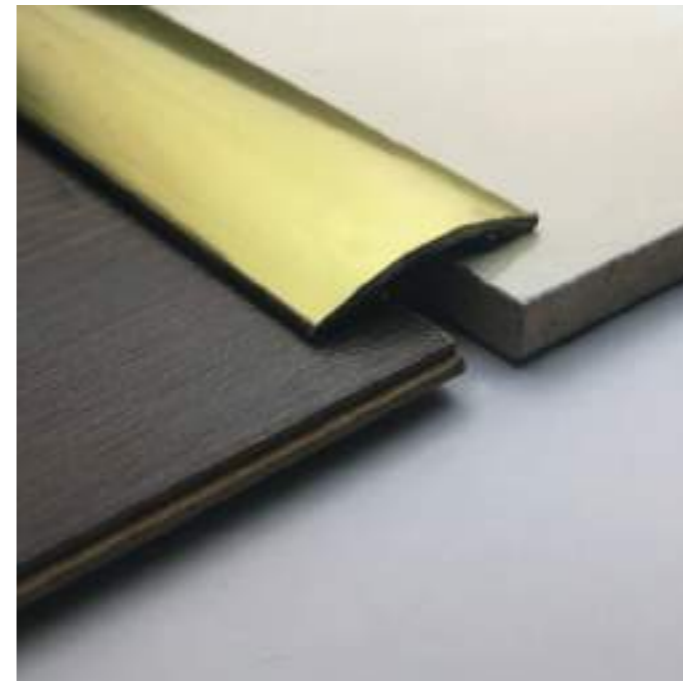

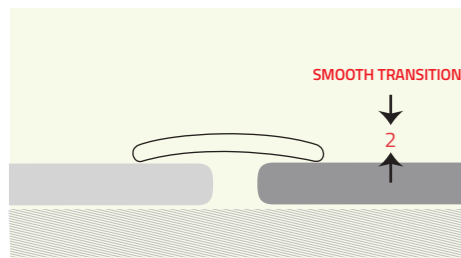
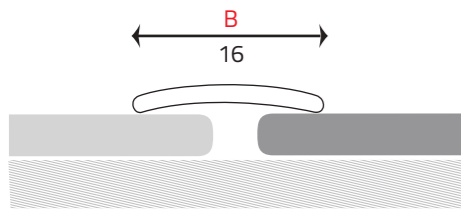

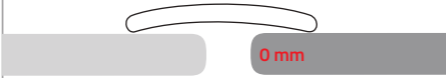
Finitura- Finish	Range di applicazione	B. (mm)	EAN	Cod.	Caratteristiche	L. (m)	Conf. - Carton	Min. ord.		
 ottone lucido polished brass	 0 mm	16	8013237003111	003M	  	0,90	10	5		
	 max 1 mm									

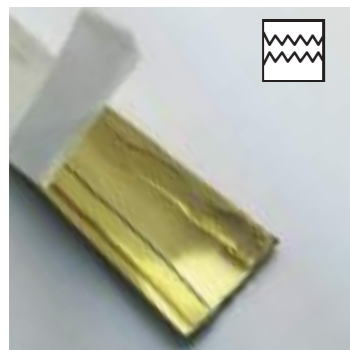

Profilo adesivo
Adhesive profile









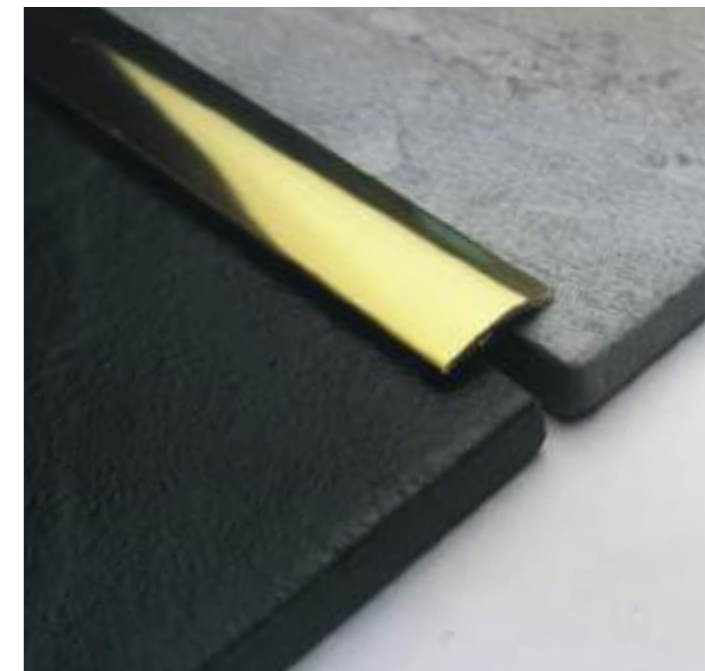
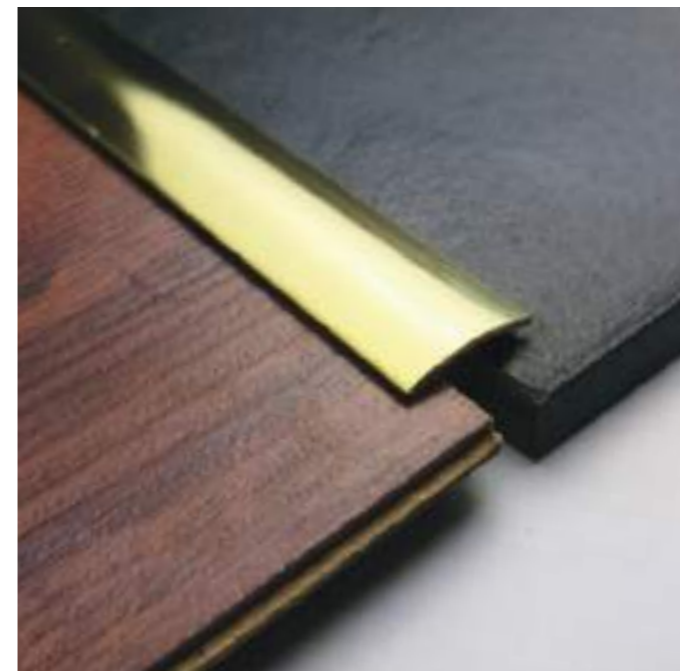



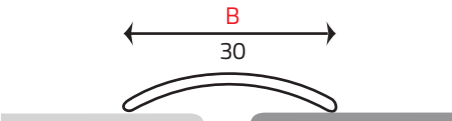
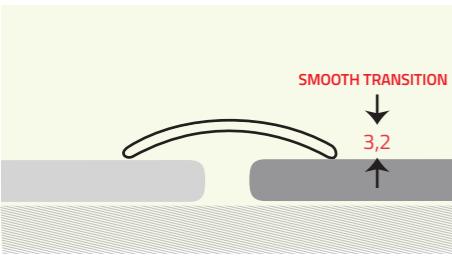







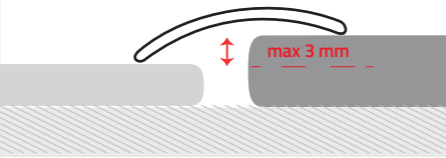



















Profilo con pellicola
Profile with film



Profilo blisterato
Profile with blister





SEMIAL	Finitura- Finish	Range di applicazione	B. (mm)	EAN	Cod.	Caratteristiche	L. (m)	Conf. - Carton	Min. ord.
  	 Alluminio naturale natural aluminum	 0 mm	30	8013237134181	024A4	 	0,90	10	5
			30	8013237134198	024A5		 	0,90	10
	 argento anodizzato satinato satin anodised silver	 max 3 mm	30	8013237003968	024A/90 	 	2,70	10	5
			30	8013237003890	023C/90 	 	2,70	10	5
			30	8013237058210	024A1/90	 	1,80	10	5
			30	8013237059606	024A3/90	 	1,66	10	5
			30	8013237002428	024B/90 	  	0,90	10	5
			30	8013237234904	023D/90 	  	0,90	10	5
	 oro anodizzato satinato satin anodised gold		30	8013237003975	024A/91	 	2,70	10	5
			30	8013237024215	024B/91	  	0,90	10	5
			30	8013237002329	023D/91 	  	0,90	10	5
 bronzo anodizzato satinato satin anodised bronze									

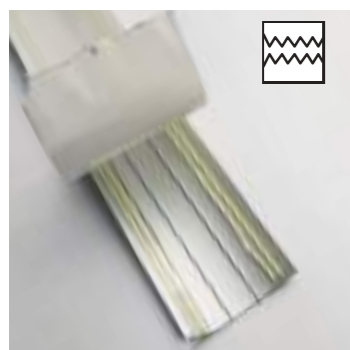

Profilo adesivo
Adhesive profile

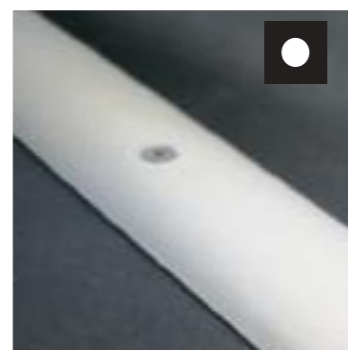

Profilo forato con viti incluse
Drilled profile with screws included





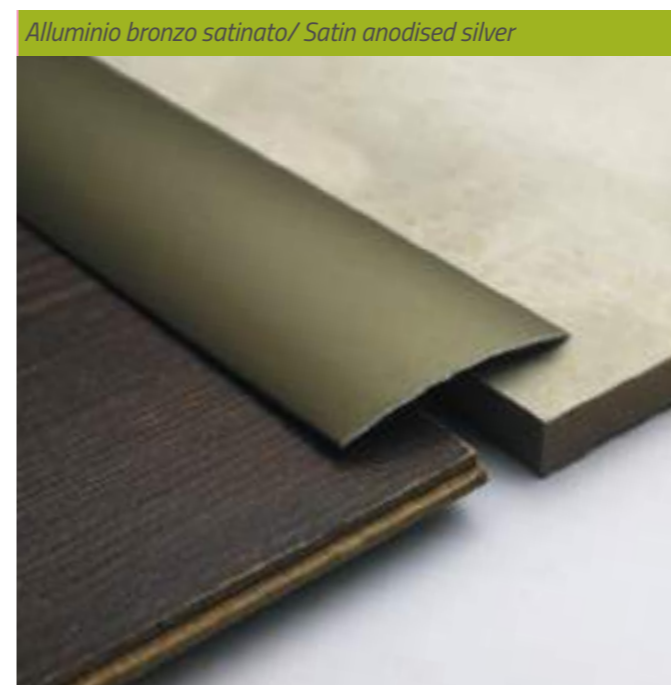

Profilo blisterato
Profile with blister

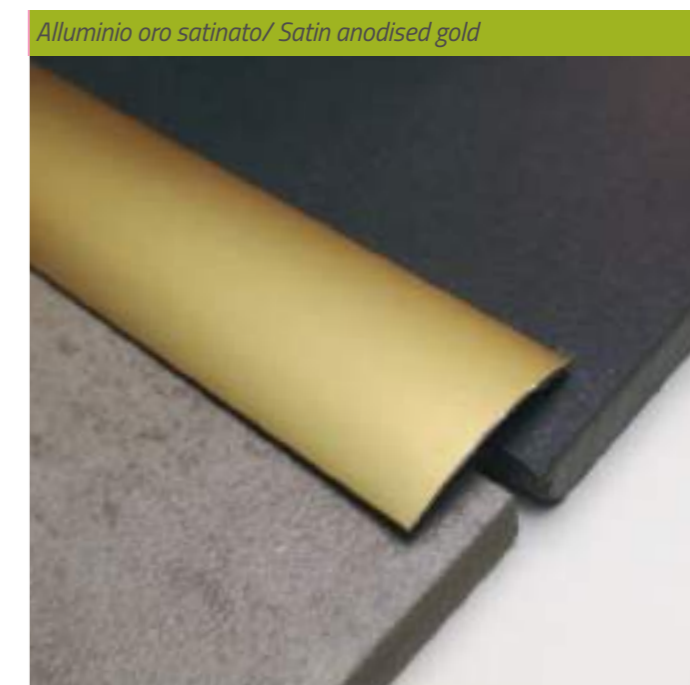

Alluminio bronzo satinato/ Satin anodised silver

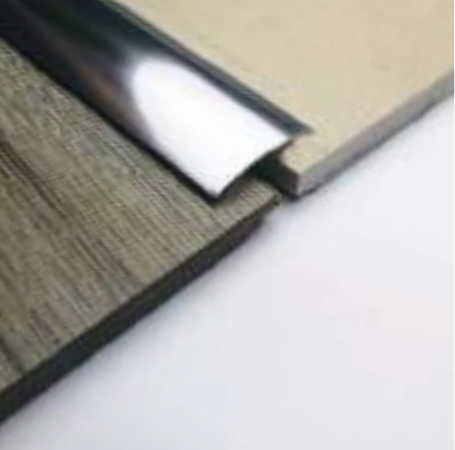
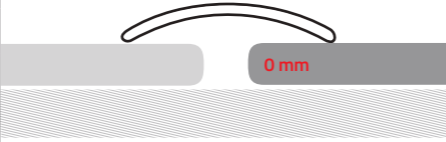

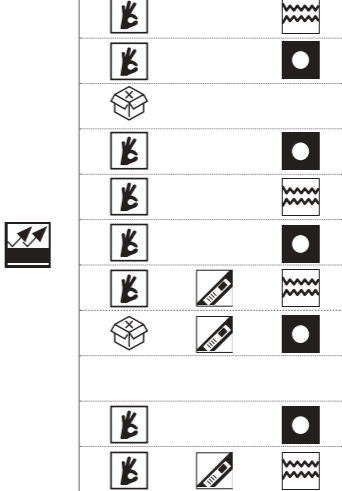
Alluminio oro satinato/ Satin anodised gold

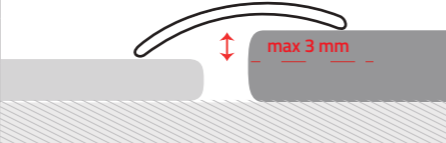
SEMIAL	Finitura- Finish	Range di applicazione	B. (mm)	EAN	Cod.	Caratteristiche	L. (m)	Conf. - Carton	Min. ord.		
	argento anodizzato lucido polished anodised silver		30	8013237025854	024C/93 		2,70	10	5		
			30	8013237026530	023E/93		2,70	10	5		
			30	8013237054298	024C1/93		1,80	10	5		
			30	8013237081416	023C1/93		1,80	10	5		
			30	8013237024437	024D/93 		0,90	10	5		
			30	8013237223939	023F/93		0,90	10	5		
	oro anodizzato lucido polished anodised gold		30	8013237024444	024D/94		0,90	10	5		
			30	8013237223946	023F/94		0,90	10	5		

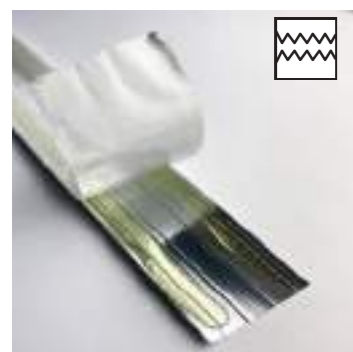
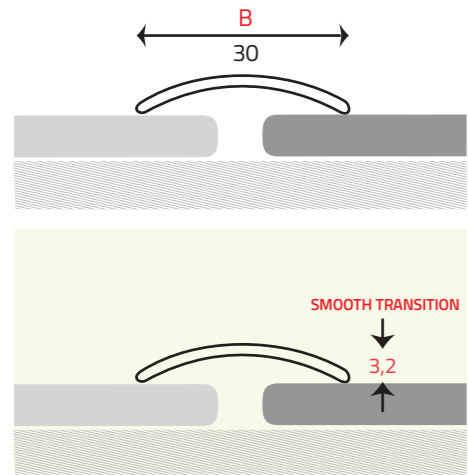

Profilo adesivo
Adhesive profile

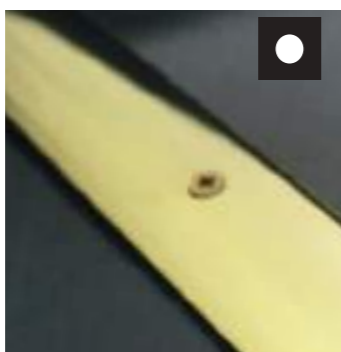

Profilo forato con viti incluse
Drilled profile with screws included



Profilo con pellicola
Profile with film



Profilo blisterato
Profile with blister

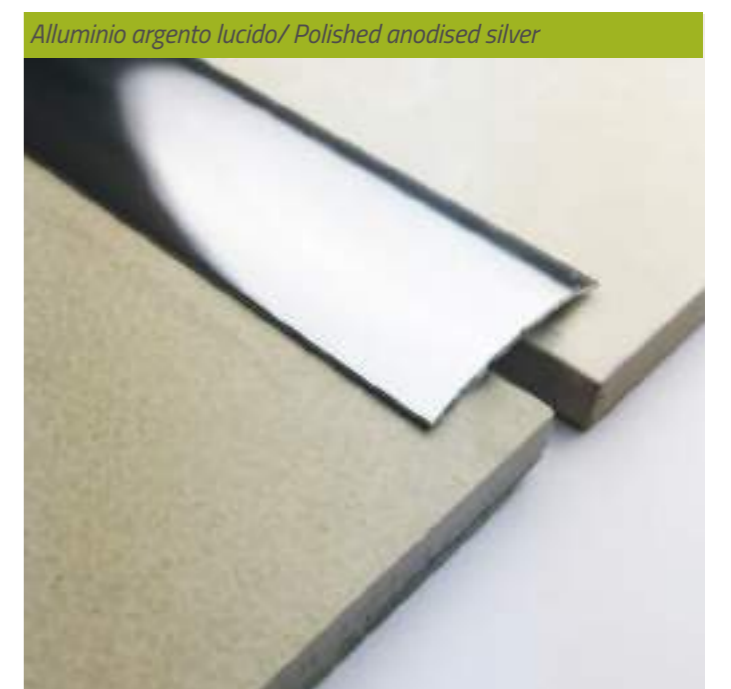
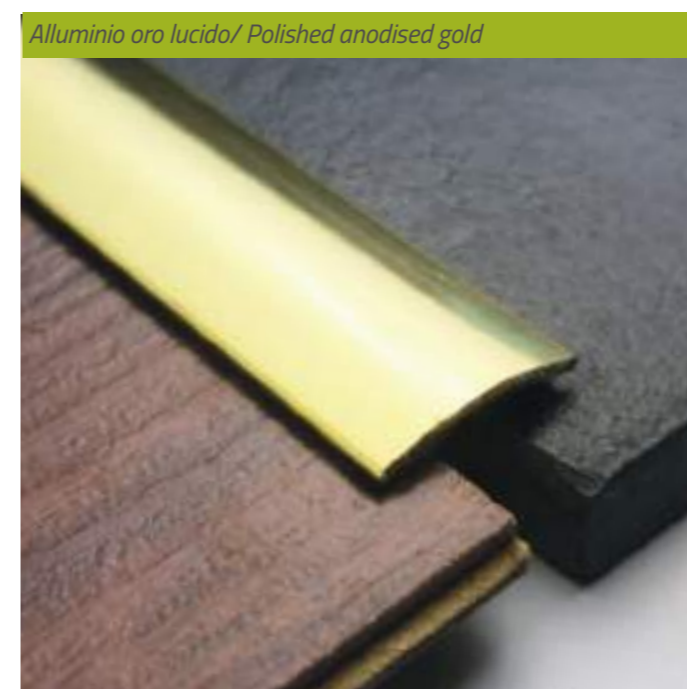

SEMIAL

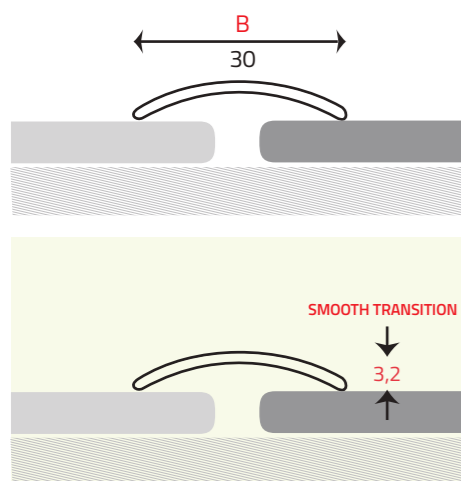
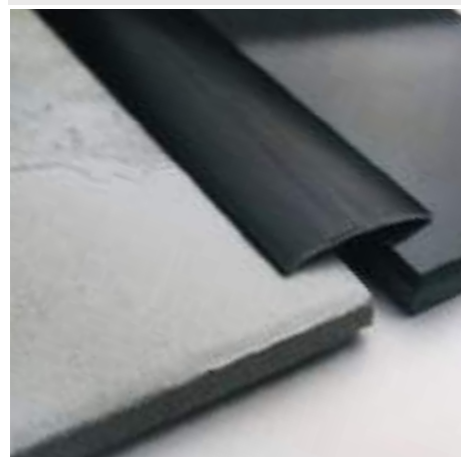

Finitura- Finish	Range di applicazione	B. (mm)	EAN	Cod.	Caratteristiche	L. (m)	Conf. - Carton	Min. ord.
nero anodizzato spazzolato brushed anodised black		30	8013237070847	024B/63		0,90	10	5
		30	8013237070878	023D/63		0,90	10	5
ramato anodizzato spazzolato brushed anodised copper		30	8013237070830	024B/99S		0,90	10	5
		30	8013237070861	023D/99S		0,90	10	5
titanio anodizzato spazzolato brushed anodised titanium		30	8013237072209	024A/96		2,70	10	5
		30	8013237070823	024B/96		0,90	10	5
		30	8013237070854	023D/96		0,90	10	5
		30	8013237070854	023D/96		0,90	10	5

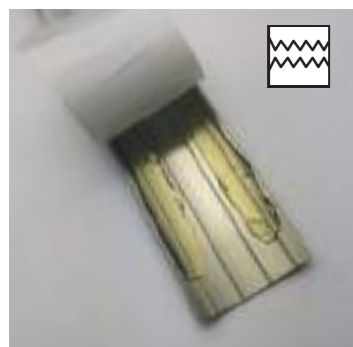

Profilo adesivo
Adhesive profile

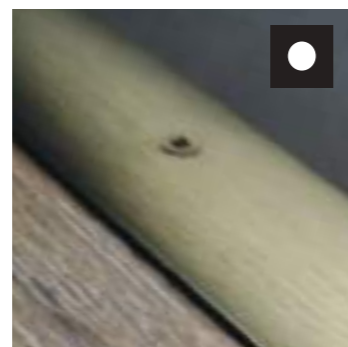

Profilo forato con viti incluse
Drilled profile with screws included



Profilo blisterato
Profile with blister

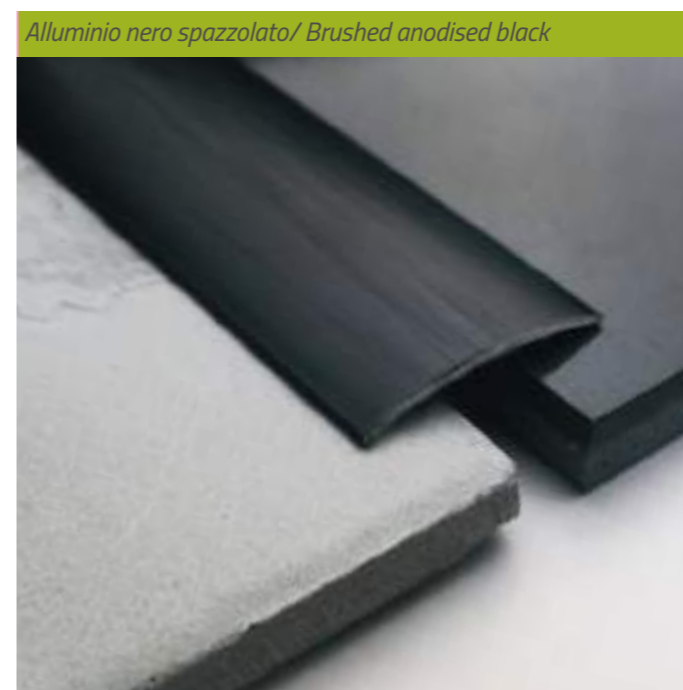

Alluminio nero spazzolato/ Brushed anodised black

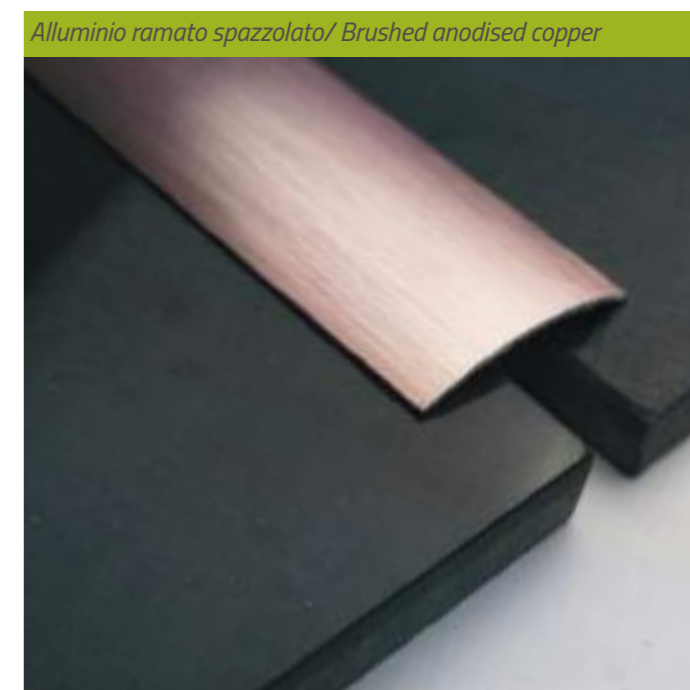

Alluminio ramato spazzolato/ Brushed anodised copper

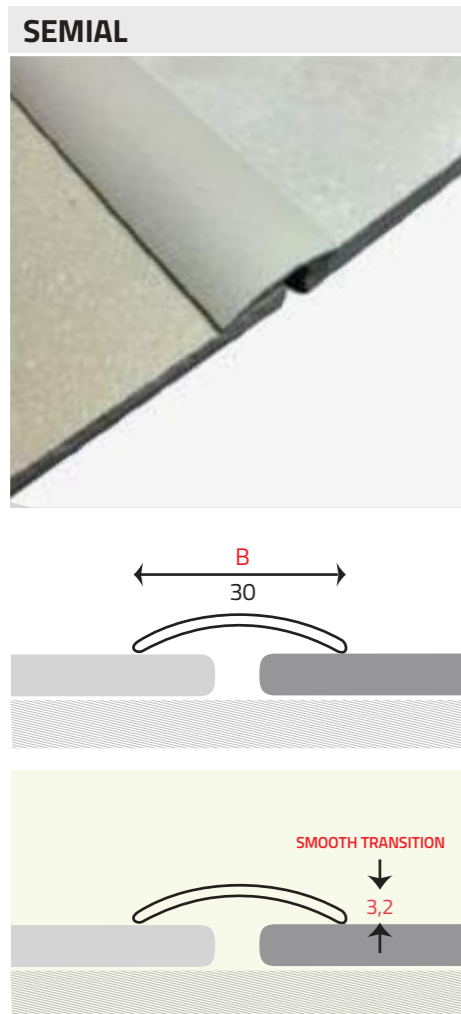









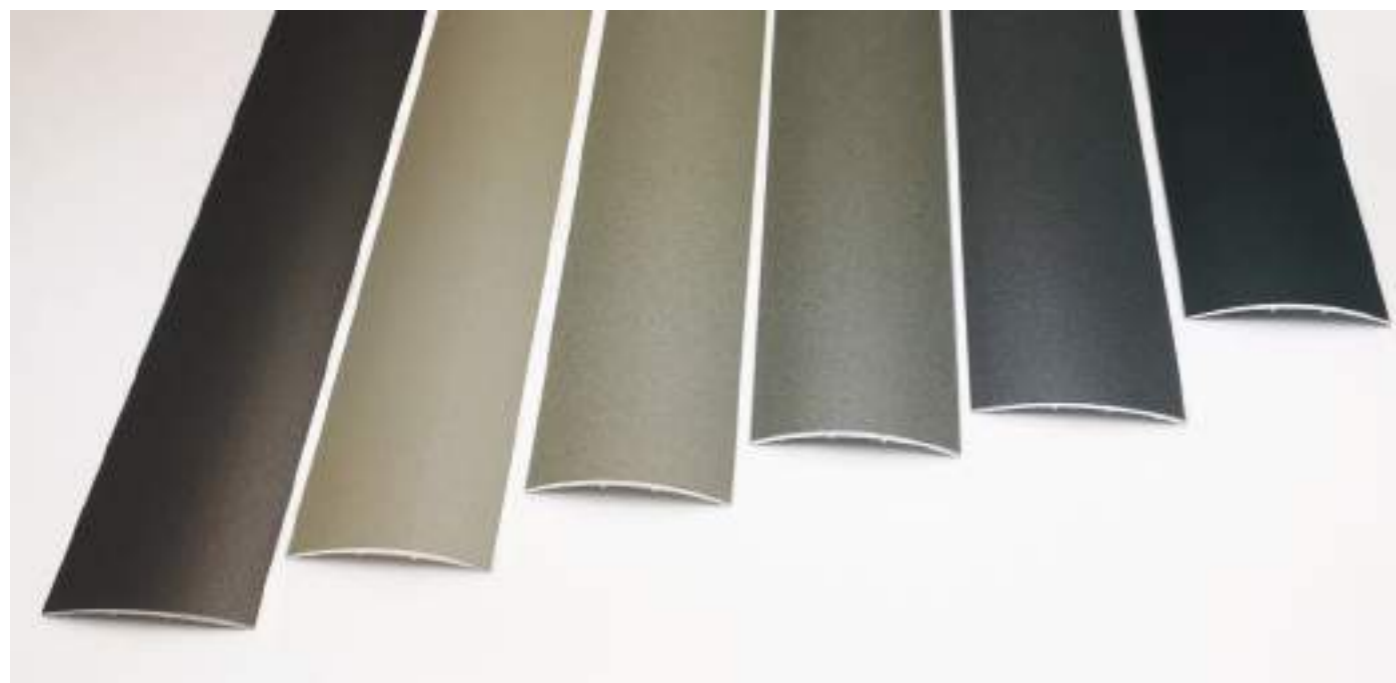



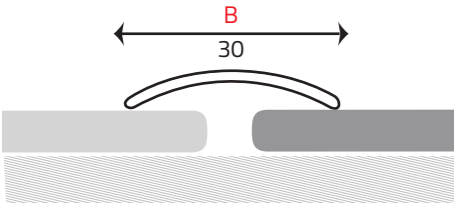

		Range di applicazione	B. (mm)	EAN	Cod.	Caratteristiche	L (m)	Conf. Carton.	Ord.min		
New			30	8013237149185	024B/100		0,90	10	5		
			30	8013237150846	024A/100		2,70	10	5		
			30	8013237149192	024B/101		0,90	10	5		
			30	8013237150853	024A/101		2,70	10	5		
			30	8013237149208	024B/102			0,90	10	5	
			30	8013237150860	024A/102			2,70	10	5	
			30	8013237149215	024B/103			0,90	10	5	
			30	8013237150884	024A/103			2,70	10	5	
			30	8013237149222	024B/104				0,90	10	5
			30	8013237150891	024A/104				2,70	10	5
			30	8013237149239	024B/105				0,90	10	5
			30	8013237150877	024A/105				2,70	10	5

Perfect Matching

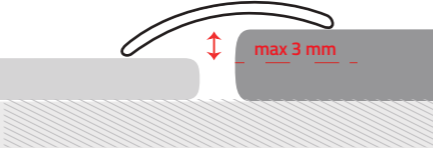
Catalogo profili fai da te/ DIY catalogue

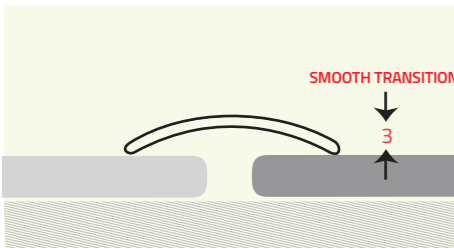
Catalogo Ceramica/ Ceramic catalogue







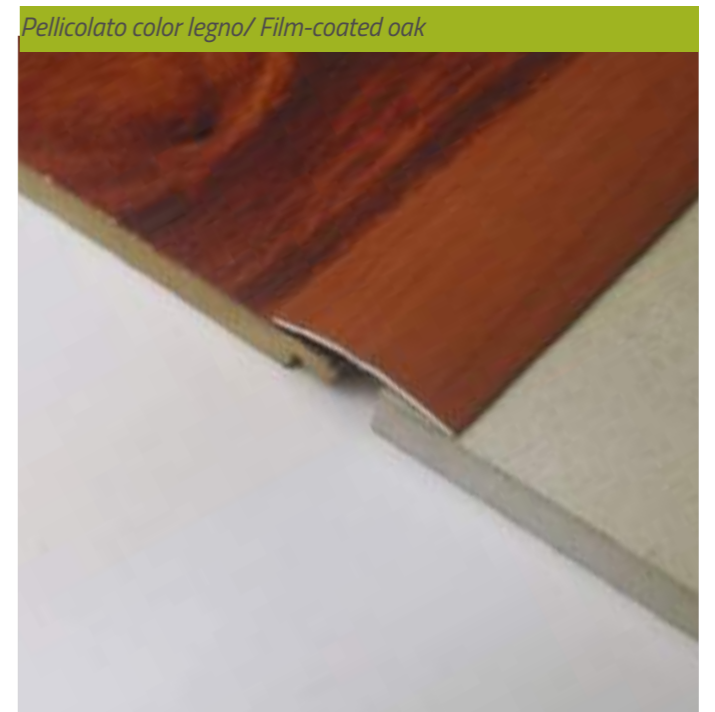
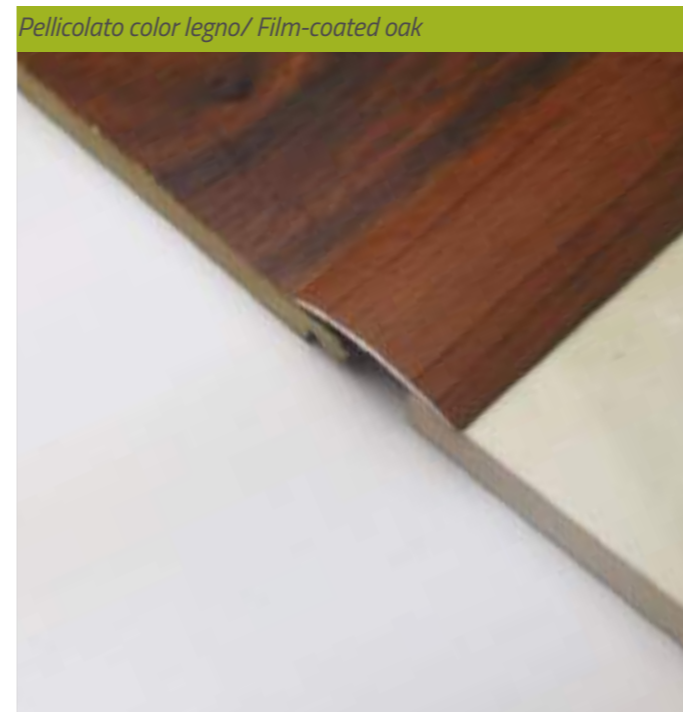

SEMIWOOD		Finitura- Finish	Range di applicazione		EAN	Cod.	(mm)	Caratteristiche	L (m)	Conf. Carton.	Ord.min			
		 rovere superior superior rovere	 0 mm	30	8013237055356	024B1A/121 (FR)		 	0,90	30	5			
		 ciliegio cherry		 max 3 mm	30	8013237054267		024A/127 (FR)		2,70	30	5		
		 noce walnut			 SMOOTH TRANSITION 3	30		8013237055332	024B1A/127 (FR)	 	0,90	30	5	
				30	8013237055349	024B1A/130 (FR)	 	0,90	30	5				

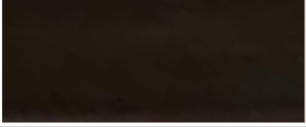
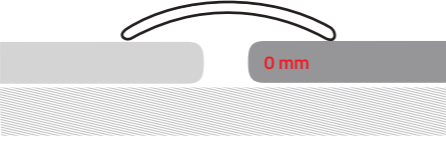

Profilo adesivo
Adhesive profile

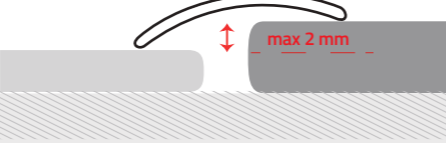

SEMIPVC	Finitura- Finish	Range di applicazione	B. (mm)	EAN	Cod.	Caratteristiche	L. (m)	Conf. - Carton	Min. ord.	
	 marrone brown	 0 mm	30	8013237134136	030/25 		0,90	10	10	
			30	8013237134242	031/25 		0,90	10	10	
	 beige beige		 max 2 mm	30	8013237134211		030/26 	0,90	10	10
				30	8013237134174		031/26 	0,90	10	10

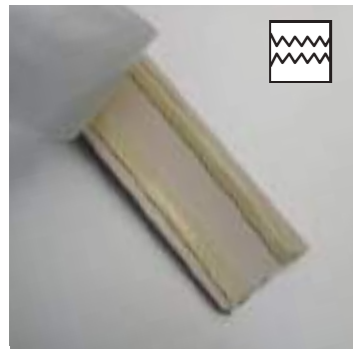
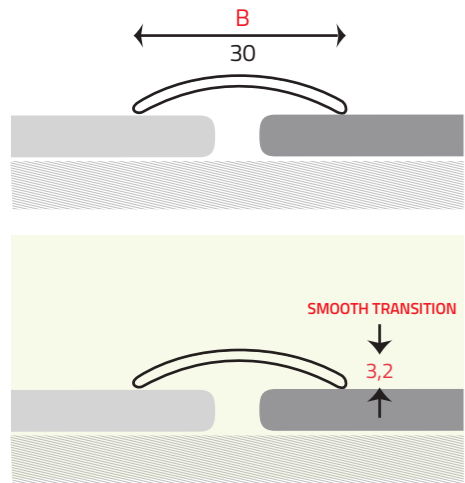

Profilo adesivo
Adhesive profile

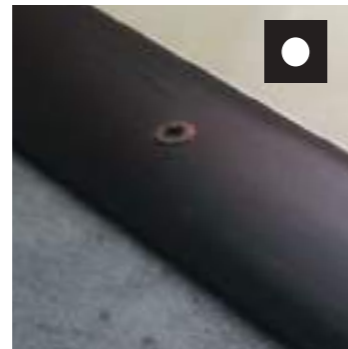

Profilo forato con viti incluse
Drilled profile with screws included



Profilo blisterato
Profile with blister





Terminali

Sloped cover strips/ Terminaisons/ Terminales

I profili Terminali Arcansas, sovrapposa e sottoposa sono progettati per eliminare qualsiasi dislivello che si può creare al momento della posa di un pavimento nuovo su uno vecchio. Progettato con sezione obliqua, è in grado di colmare qualsiasi gap minimizzando il rischio di incidenti e armonizzare le differenze fra diverse pavimentazioni di diversa finitura. La sua funzione di raccordo tra pavimenti di diversa natura e spessore permette di coprire eventuali scheggiature dei bordi in ceramica e tagli imperfetti dei pavimenti in legno.
finiture disponibili: acciaio inox aisi 304, ottone, alluminio.

- Vantaggi:**
- Altamente decorativi
 - Resistenti al calpestio
 - Resistenza ai graffi
 - Scarsa manutenzione
 - Possibilità di applicazioni: con viti e/ o autoadesivo inclusi)
 - Diversi colori disponibili

Arcansas' end profiles, under-tile and over-tile, are conceived to fix any difference in level caused by the application of a new flooring on an old one. Designed with an oblique section this product can manage to fill any gap in order to minimize the risk of accidents but also to nicely link different floorings of different finishings. Its joint function leads to cover any chipping in the tiles edges and the imperfections in wood cutting.









- Strong points:**
- Highly decorative
 - Resistant to foot traffic and scratches
 - Applicable to different kind of floorings
 - Easy application thanks to screws or glue/adhesive tape
 - Little maintenance is required
 - Wide range of colours

Les profilés de terminaison Arcansas, de sur-pose et de sous-pose sont conçus pour éliminer toute irrégularité pouvant être créée lors de la pose d'un nouveau sol sur un ancien. Conçu avec une section oblique, il comble tout espace en minimisant les risques d'accident et en harmonisant les différences entre les sols aux finitions diverses. Sa fonction de liaison entre des planchers de nature et d'épaisseur différente permet de couvrir tout ébrèchement des bords en céramique et coupes imparfaites des planchers en bois.
Finitions disponibles : acier inoxydable aisi 304, laiton, aluminium.

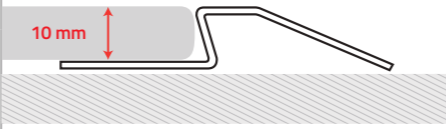
- Avantages:**
- Très décoratif
 - Résistant au piétinement
 - Résistance aux rayures
 - Faible entretien
 - Facile à appliquer (avec vis ou colle/adhésif inclus)
 - Différentes couleurs disponibles

Los perfiles terminales Arcansas, sobrepuestos y contrapuestos, están diseñados para eliminar los desniveles que se puedan crear al colocar un nuevo suelo sobre uno antiguo. Diseñado con una sección oblicua, es capaz de llenar cualquier hueco minimizando el riesgo de accidentes y armonizando las diferencias entre distintos suelos de distintos acabados. Su función de unión entre suelos de diferente naturaleza y espesores permite tapar cualquier desportillado de los cantos cerámicos y cortes imperfectos de los suelos de madera.
acabados disponibles: acero inoxidable aisi 304, latón, aluminio.

- Ventajas:**
- Altamente decorativo
 - Resistente al tráfico peatonal
 - Resistencia al rayado
 - Fácil aplicación (con tornillos o pegamento/adhesivo)
 - Se necesita de poco mantenimiento
 - Amplia gama de colores

SCIVOINOX	Finitura- Finish	Range di applicazione		EAN	Cod.	Caratteristiche	L. (m)	Conf. - Carton	Min. ord.		
	 acciaio inox lucido AISI 304 polished AISI 304 s.steel		10	8013237006396	052E4 		2,70	10	5		
				8013237052928	052E4B 	 	0,90	10	5		

SOTTOPOSA - UNDERTILE

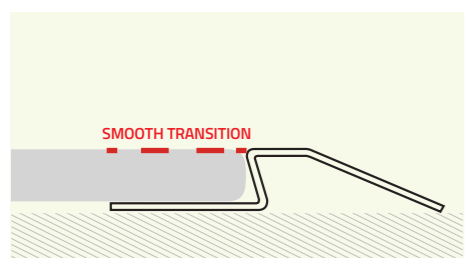
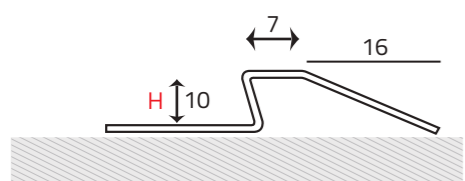

Profilo con pellicola
Profile with film



Profilo blisterato
Profile with blister

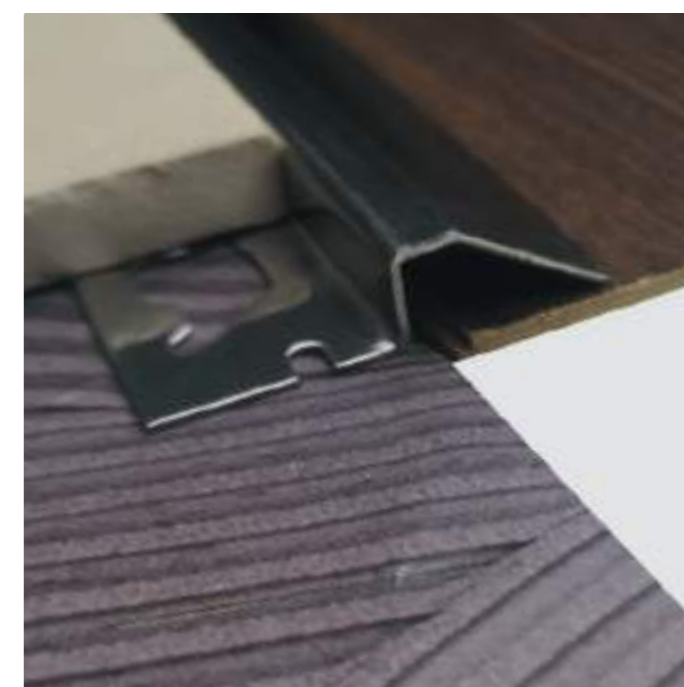
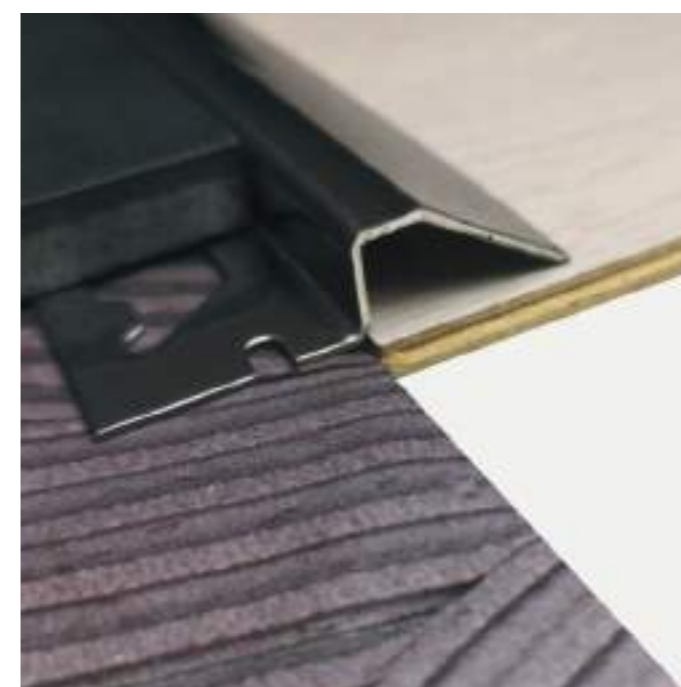





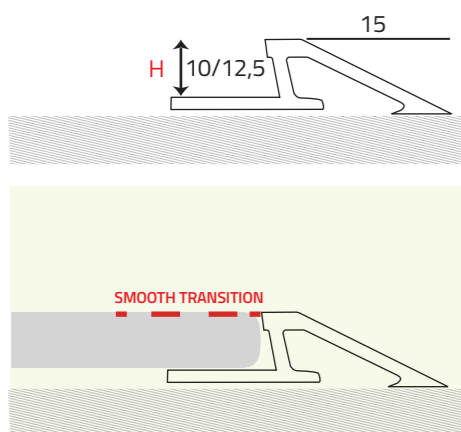



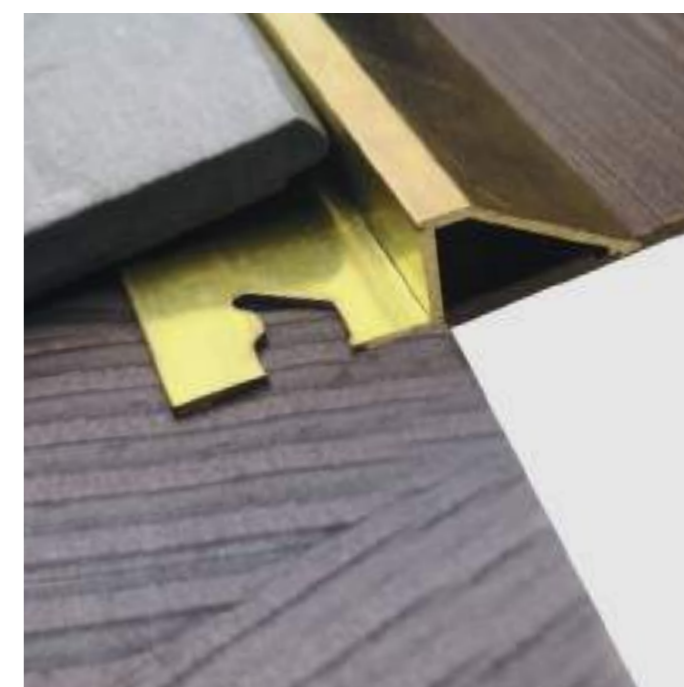
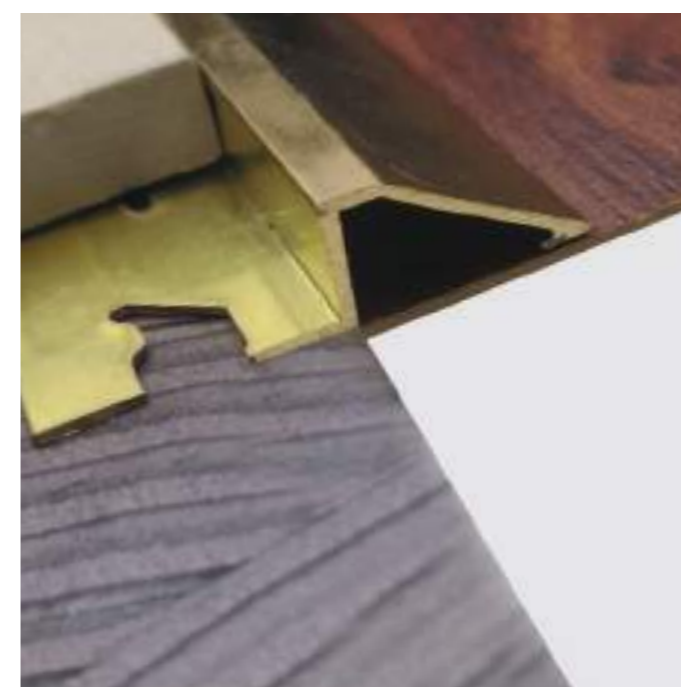

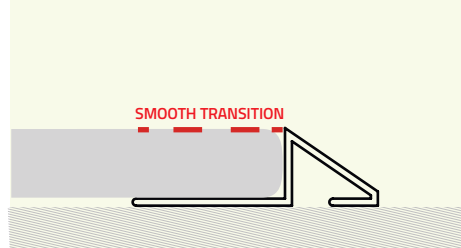

Finitura- Finish	Range di applicazione	EAN	Cod.	Caratteristiche	L. (m)	Conf. - Carton	Min. ord.		
ottone lucido polished brass	 	8013237003135	009G3B		0,90	10	5		



Profilo blisterato
Profile with blister







SCIVOALU	Finitura- Finish	Range di applicazione	H. (mm)	EAN	Cod.	Caratteristiche	L. (m)	Conf. - Carton	Min. ord.
 <p>SOTTOPOSA - UNDERTILE</p>  	argento anodizzato satinato anodised satin silver	  	8	8013237148638	052H/90 	 	2,70	10	5
			10	8013237083816	052L/90 		2,70	10	5
			10	8013237085384	052L1/90		0,90	10	5
			12,5	8013237133702	052L2/90 		2,70	10	5
			12,5	8013237138486	052L3/90		0,90	10	5

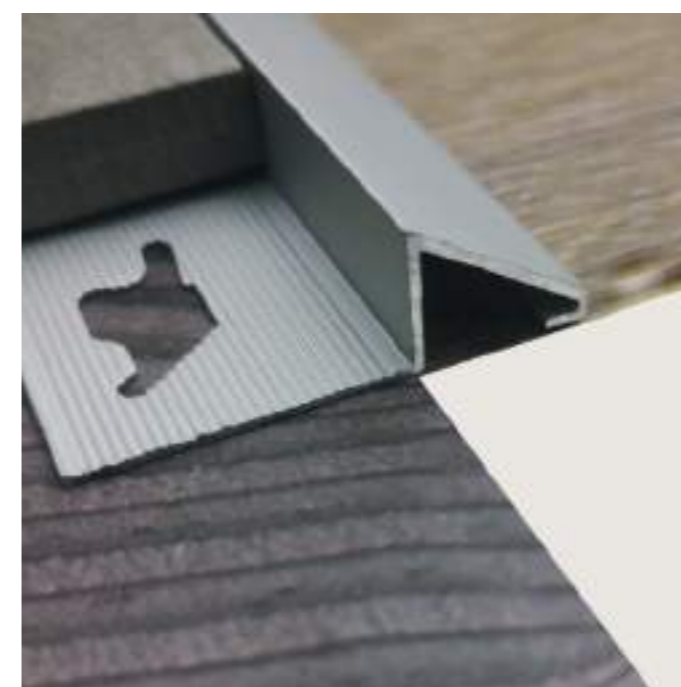

Profilo blisterato
Profile with blister

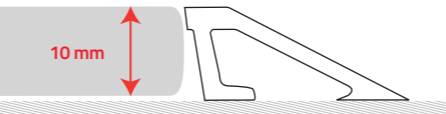

SCIVOTAV	Finitura- Finish	Range di applicazione	H. (mm)	EAN	Cod.	Caratteristiche	L. (m)	Conf. - Carton	Min. ord.		
	 ottone naturale natural brass										
	 ottone lucido polished brass										

SOVRAPOSA-OVERTILE

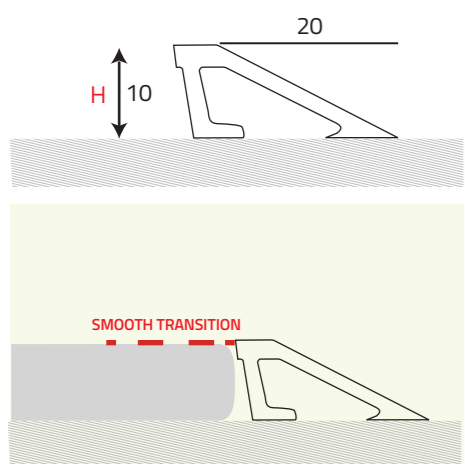

Profilo blisterato
Profile with blister

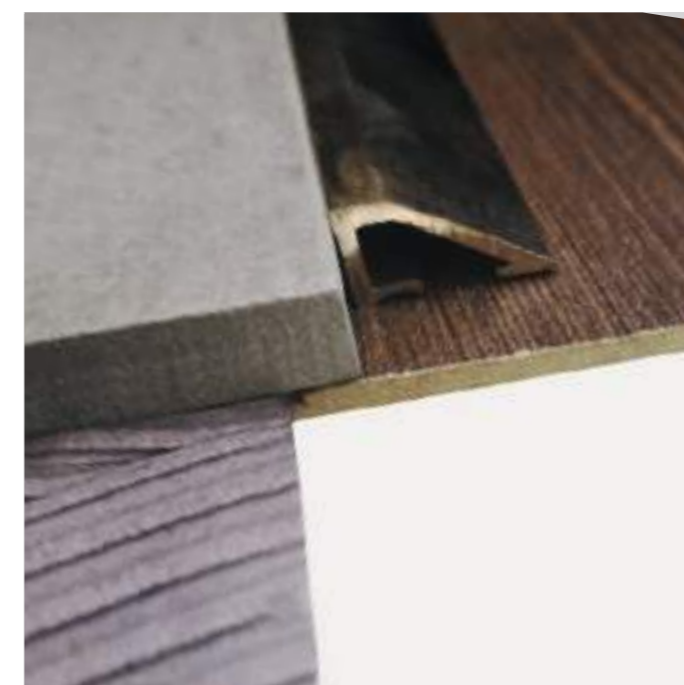
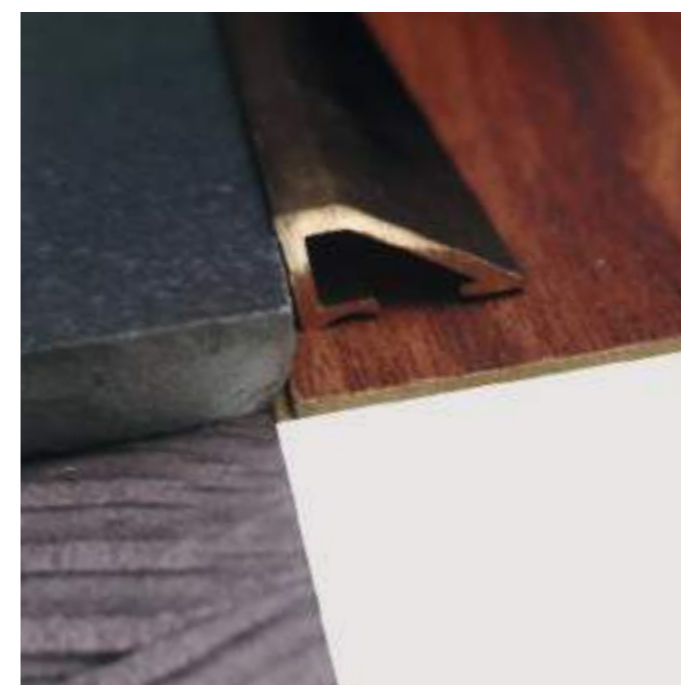

PIEDINOX	Finitura- Finish	Range di applicazione	H. (mm)	EAN	Cod.	Caratteristiche	L. (m)	Conf. - Carton	Min. ord.
	acciaio inox lucido AISI 304 polished AISI 304 s.steel		8	8013237005849	047		2,70	10	5
			8	8013237000493	049			0,90	10

SOVRAPOSA-OVERTILE

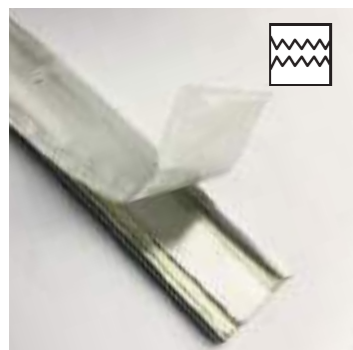
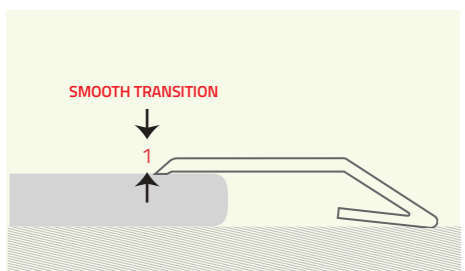
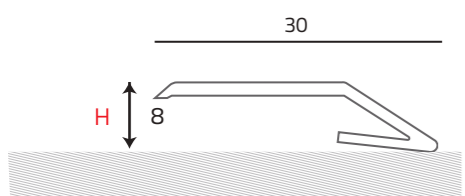

Profilo adesivo
Adhesive blister



Profilo con pellicola
Profile with film



Profilo blisterato
Profile with blister





SOVRAPOSA-OVERTILE

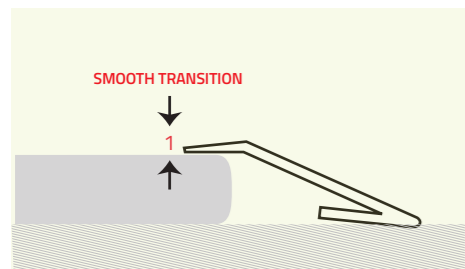
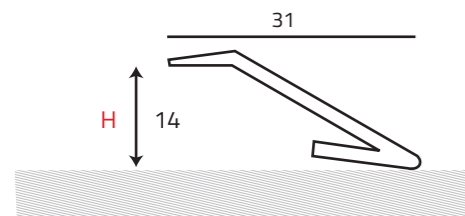
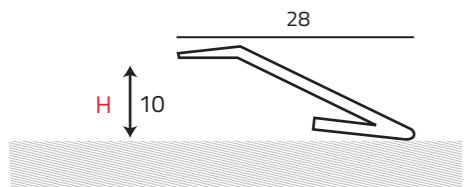

Finitura- Finish	Range di applicazione	H. (mm)	EAN	Cod.	Caratteristiche	L. (m)	Conf. - Carton	Min. ord.
acciaio inox lucido AISI 304 polished AISI 304 s.steel		10	8013237006280	052C		2,70	10	5
		10	8013237005245	052D		1,00	10	5
		10	8013237052416	052D1		0,90	10	5
		14 mm						
		max 12mm						
		max 16mm						



Profilo adesivo
Adhesive profile

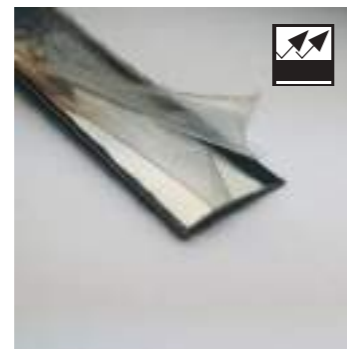

Profilo con pellicola
Profile with film



Profilo blisterato
Profile with blister





SOVRAPOSA-OVERTILE

Finitura- Finish	Range di applicazione	H. (mm)	EAN	Cod.	Caratteristiche	L. (m)	Conf. - Carton	Min. ord.
acciaio inox lucido AISI 430 polished AISI 430 s.steel	 7 mm							
	 max 12 mm							

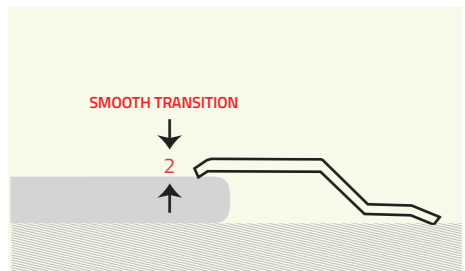
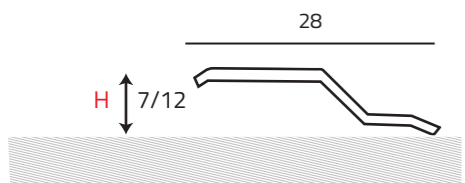

Punti di forza Strengths

Profilo che consente la giunzione di pavimentazioni adiacenti con dislivello. Particolarmente adatto all'utilizzo in ambienti controllati come laboratori alimentari, sanitari, piscine, ambienti esterni in genere e particolarmente indicato per usi in ambienti igienici.

This kind of profiles is conceived to link adjacent unequal floorings and it is particularly suitable to certification-subjected-settings, such as food laboratories, sanitary environments, swimming pools, outdoor spaces. Perfectly suitable to highly-hygienical-required spaces

Profil qui permet la jonction de sols adjacents ayant une différence de hauteur. Particulièrement adapté pour une utilisation dans des environnements contrôlés tels que ceux de l'alimentation, la santé, les piscines, les environnements extérieurs en général, son usage est recommandé dans des environnements sanitaires.

Perfil que permite la unión de pisos contiguos con desnivel. Su uso es particularmente adecuado para ambientes controlados como laboratorios de alimentos, laboratorios de salud, piscinas, ambientes al aire libre en general y particularmente adecuado para ambientes sanitizados.



Profilo adesivo
Adhesive profile



Profilo con pellicola
Profile with film





Profilo blisterato
Profile with blister



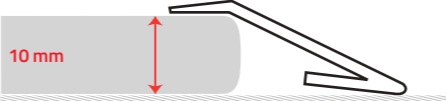
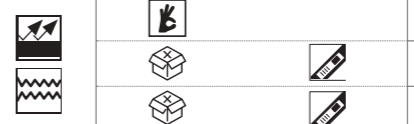

SOVRAPOSA-OVERTILE

Finitura- Finish	Range di applicazione	H. (mm)	EAN	Cod.	Caratteristiche	L. (m)	Conf. - Carton	Min. ord.
 ottone lucido polished brass	 10 mm	10	8013237000721	007B		1,00	10	5
	 max 12 mm	10	8013237000738	007C			0,90	10

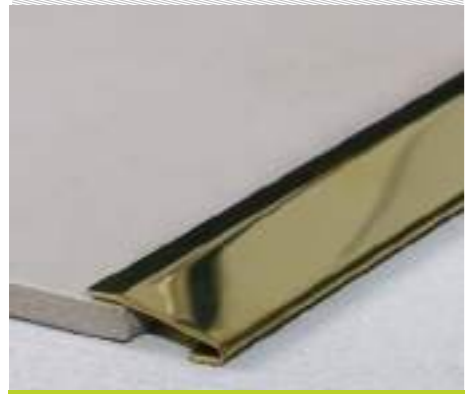
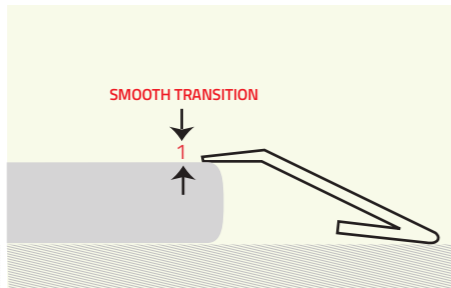
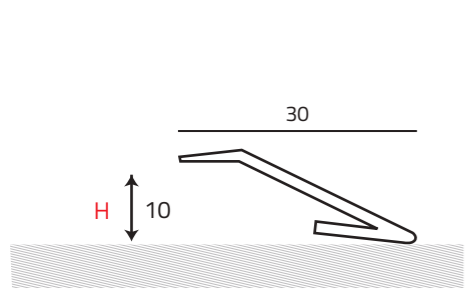

SOVRAPOSA-OVERTILE

Finitura- Finish	Range di applicazione	H. (mm)	EAN	Cod.	Caratteristiche	L. (m)	Conf. - Carton	Min. ord.
 ottone lucido polished brass	 14 mm							
	 max 16 mm							

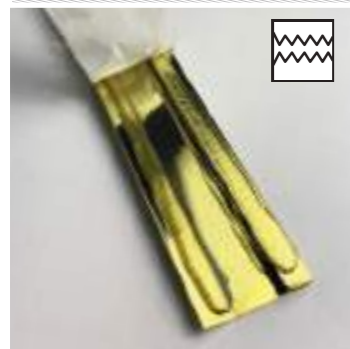
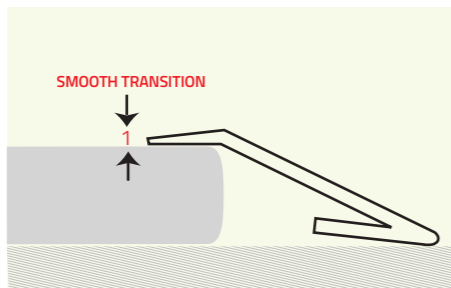
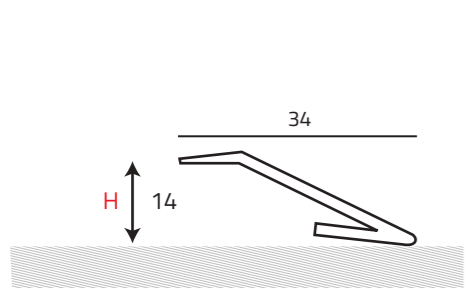

Profilo adesivo
Adhesive profile

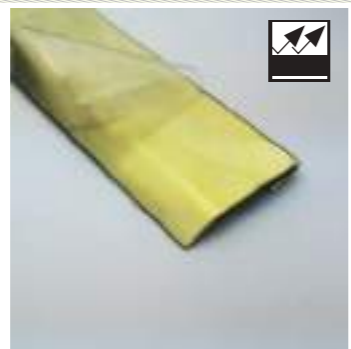



Profilo con pellicola
Profile with film

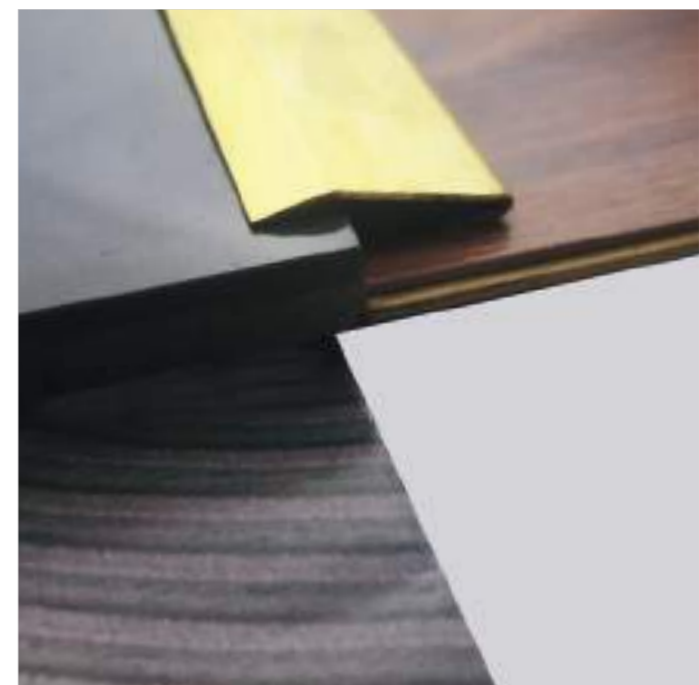
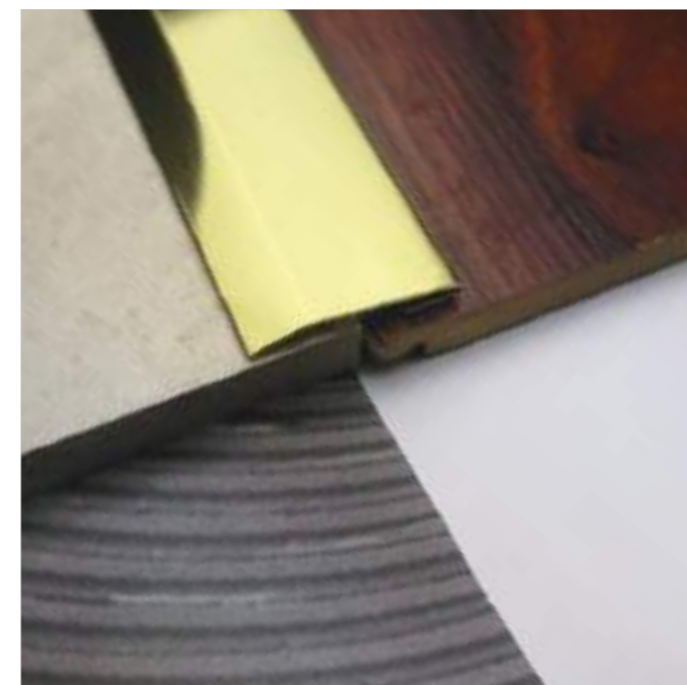

Profilo blisterato
Profile with blister

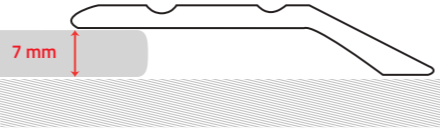
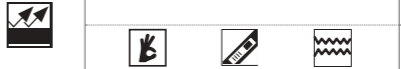

PIEDSCAN	Finitura- Finish	Range di applicazione	H. (mm)	EAN	Cod.	Caratteristiche	L. (m)	Conf. - Carton	Min. ord.
	 ottone lucido polished brass		7	8013237000356	003E		0,90	10	5
SOVRAPOSA-OVERTILE									

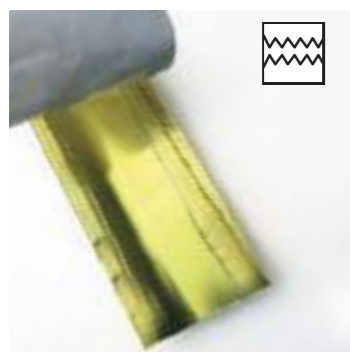
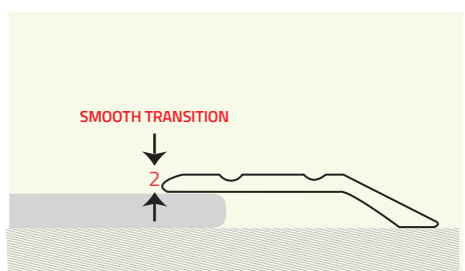
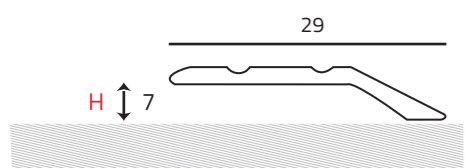

Profilo adesivo
Adhesive profile

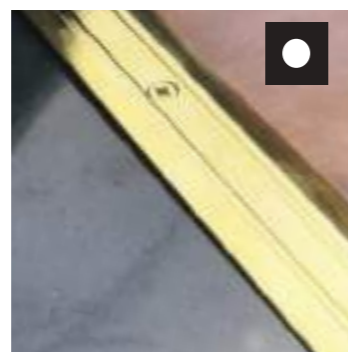

Profilo forato con viti incluse
Drilled profile with screws included



Profilo blisterato
Profile with blister

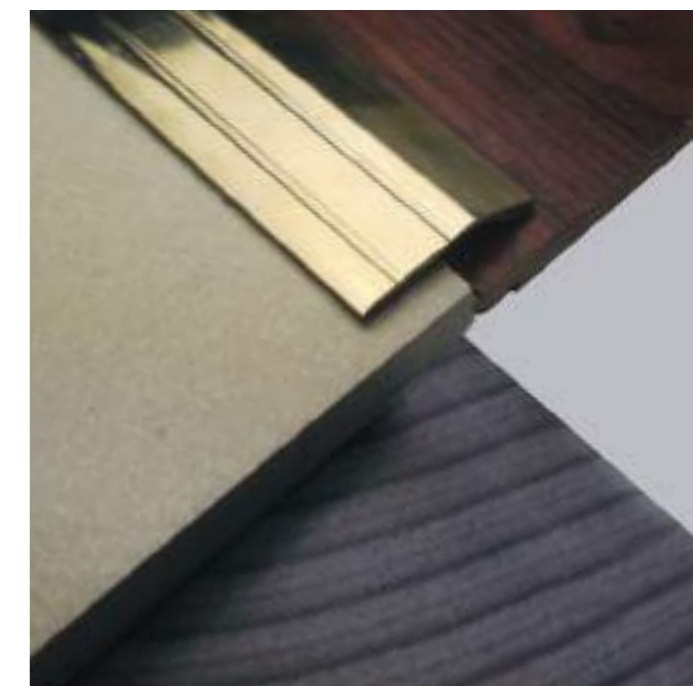
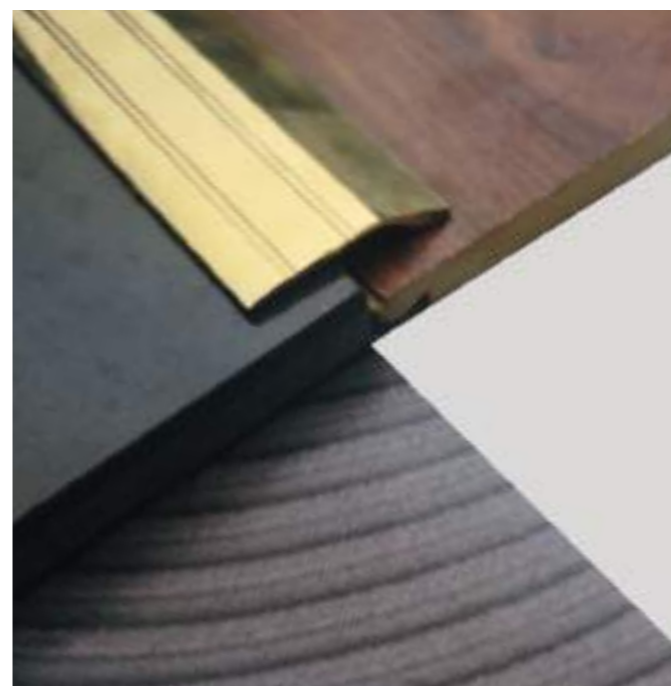



SOVRAPOSA-OVERTILE

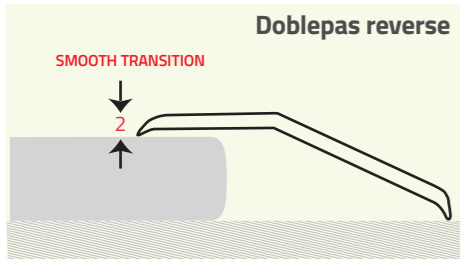
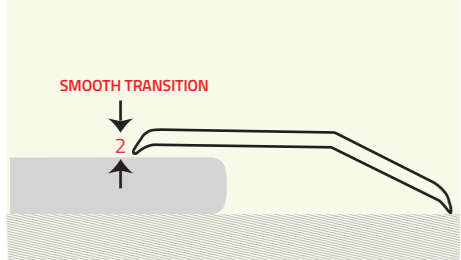
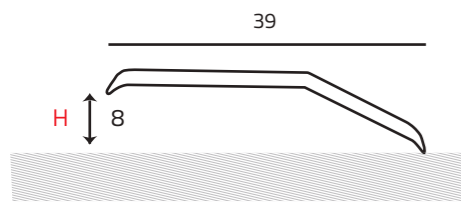

Finitura- Finish

ottone lucido
polished brass

Range di applicazione

8 mm

max 10 mm

Doblepas reverse

12 mm

max 14 mm

	EAN	Cod.	Caratteristiche	L. (m)	Conf. - Carton	Min. ord.		
8	8013237003722	003G2		0,90	10	5		



Profilo adesivo
Adhesive profile

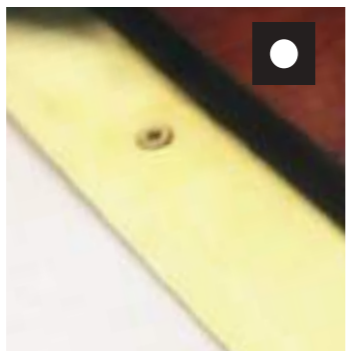

Profilo forato con viti incluse
Drilled profile with screws included





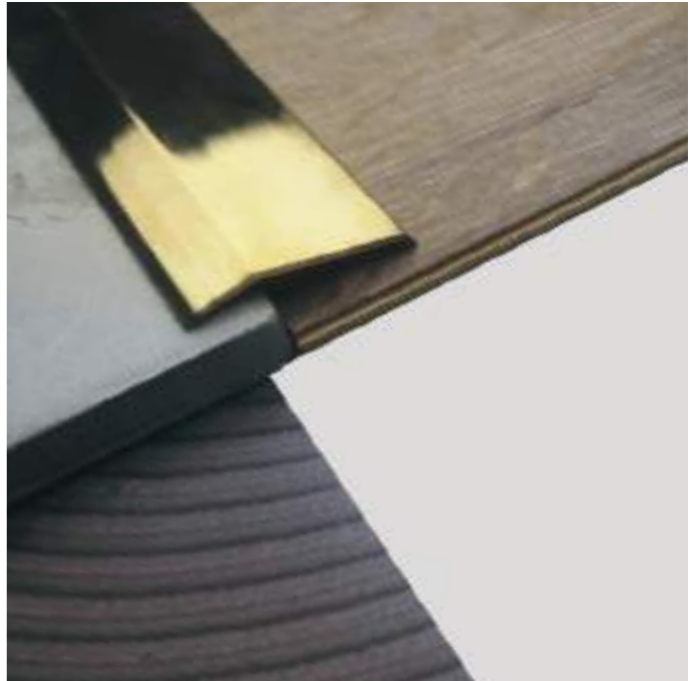
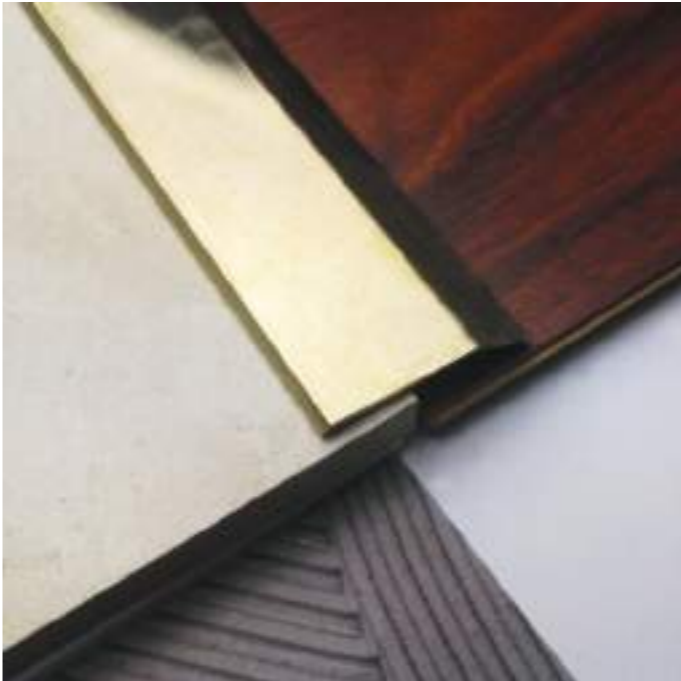

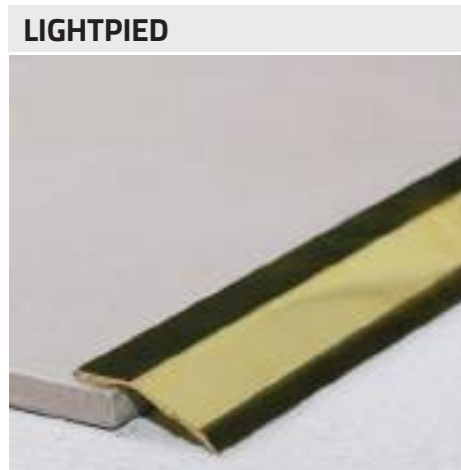

Profilo blisterato
Profile with blister

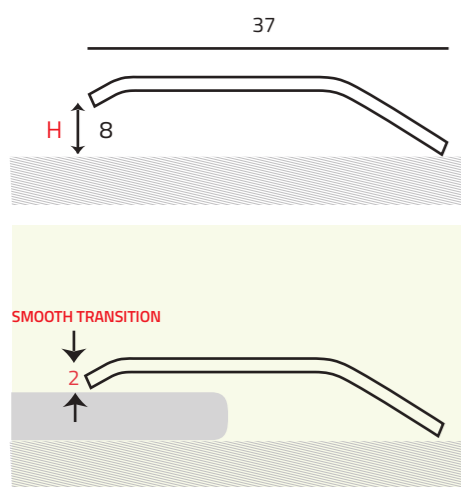

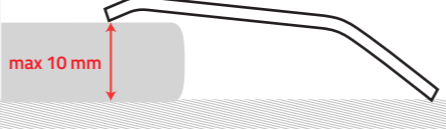

SOVRAPOSA-OVERTILE



Finitura- Finish	Range di applicazione	EAN	Cod.	Caratteristiche	L. (m)	Conf. - Carton	Min. ord.
 <p>ottone lucido polished brass</p>	 <p>8 mm</p>  <p>max 10 mm</p>	8013237003647	003F4	  	0,90	10	5

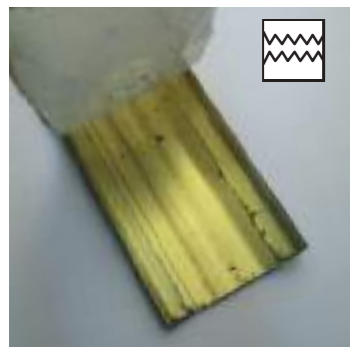

Profilo adesivo
Adhesive profile

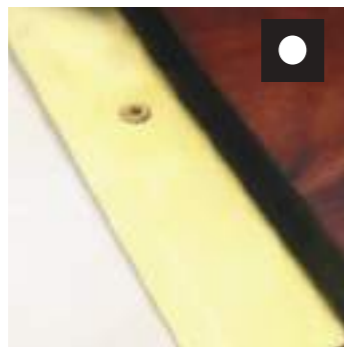

Profilo forato con viti incluse
Drilled profile with screws included

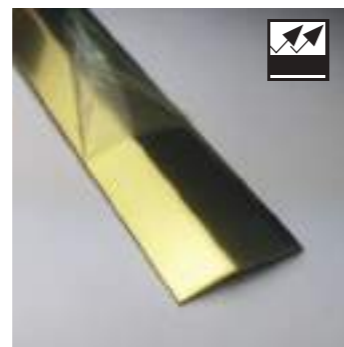







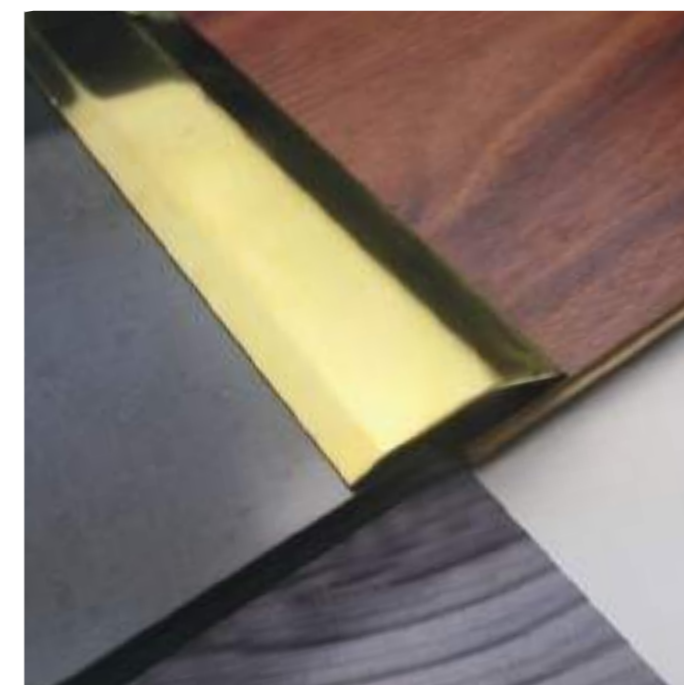

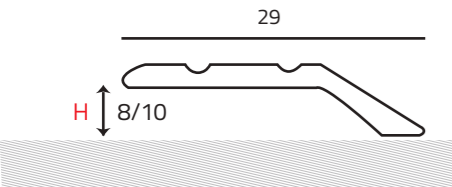
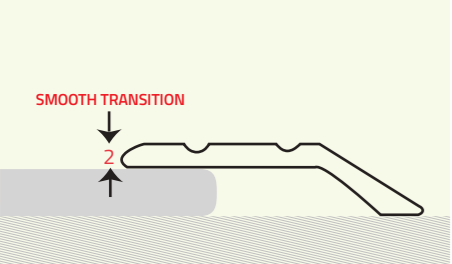
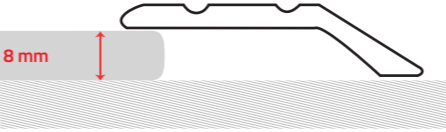
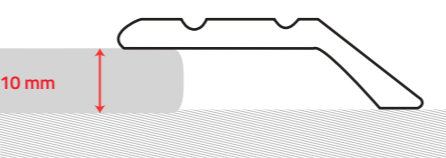























Profilo con pellicola
Profile with film



Profilo blisterato
Profile with blister



PIEDAL	Finitura- Finish	Range di applicazione	H. (mm)	EAN	Cod.	Caratteristiche	L. (m)	Conf. - Carton	Min. ord.
 <p>SOVRAPOSA-OVERTILE</p>  	argento anodizzato satinato anodised satin silver	 	8	8013237004484	032K/90 FR	 	2,70	10	5
			8	8013237004590	032N/90	 	2,70	10	5
			8	8013237054304	032K1/90	 	1,80	10	5
			8	8013237032104	032L/90 FR	  	0,90	10	5
			8	8013237032135	032M/90	  	0,90	10	5
			10	8013237090005	032P/90	 	2,70	10	5
			10	8013237062248	032P2/90	 	0,90	10	5
			10	8013237134860	032P3/90	 	1,80	10	5
			10	8013237037802	032S/90	  	0,90	10	5
			10	8013237036539	032R/90 FR	 	2,70	10	5
			10	8013237134853	032R1/90 FR	 	1,80	10	5
				oro anodizzato satinato anodised gold satin		8	8013237003289	032L/91	  
	bronzo anodizzato satinato anodised satin bronze		10	8013237037796	032S/91	  	0,90	10	5

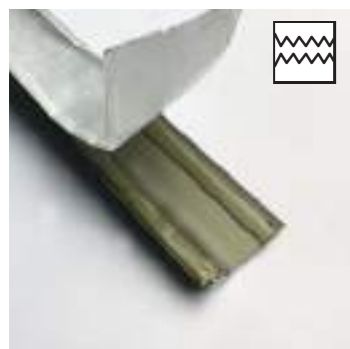

Profilo adesivo
Adhesive profile

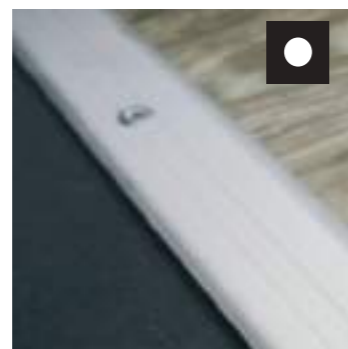

Profilo forato con viti incluse
Drilled profile with screws included





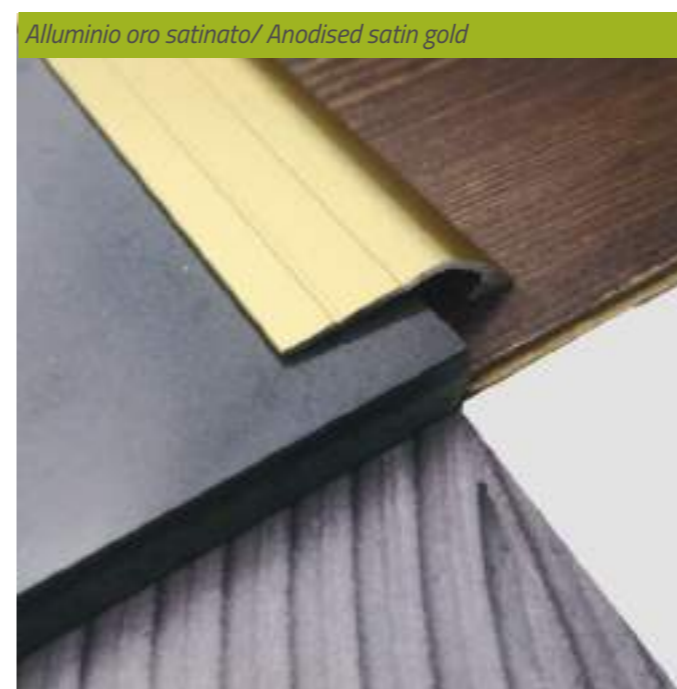

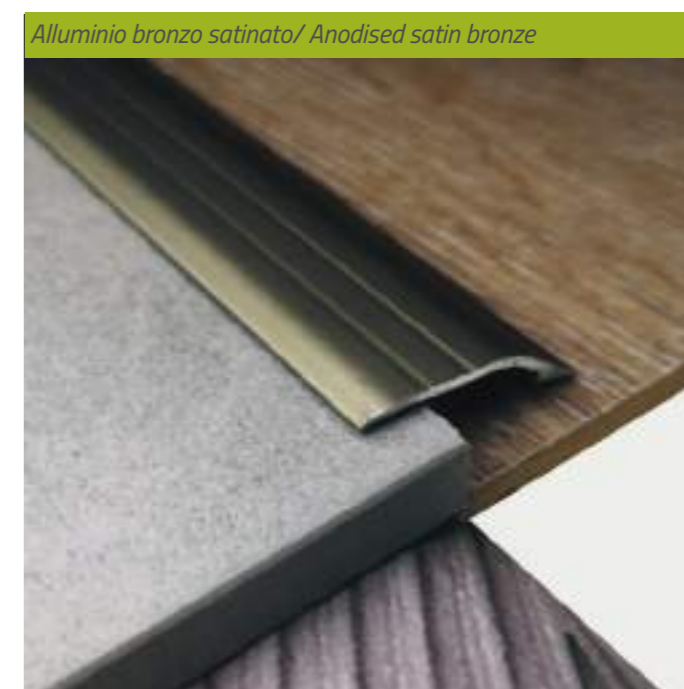

Profilo blisterato
Profile with blister



Alluminio oro satinato/ Anodised satin gold

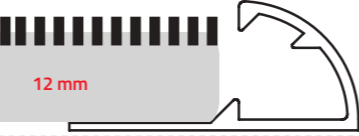

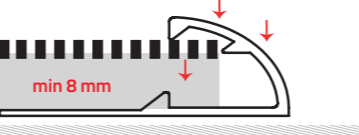
Alluminio bronzo satinato/ Anodised satin bronze

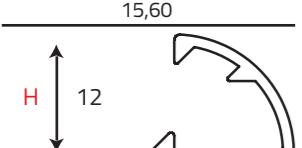
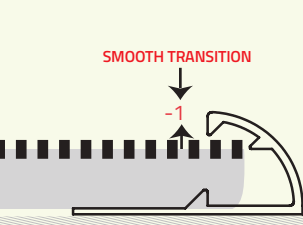
GUSCIOAL		Finitura- Finish	Range di applicazione	H. (mm)	EAN	Cod.	Caratteristiche	L. (m)	Conf. - Carton	Min. ord.		
		argento anodizzato satinato anodised satin silver		12	8013237028817	028H1/90	 	0,90	30	5		
		oro anodizzato satinato anodised gold satin		12	8013237056506	028H4/90	 	0,90	30	5		
SOTTOPOSA - UNDERTILE												
												
												



Punti di forza Strengths

Adatto alla giunzione tra pavimenti in ceramica/parquet e moquette

Suitable to joint moquette flooring with ceramic/parquet ones

Convient pour l'assemblage de sols en céramique/parquet et de moquette

Adecuado para unir suelos cerámicos/parquet y moqueta

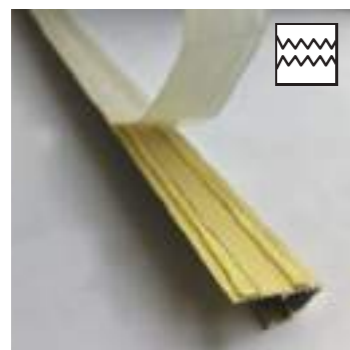

Profilo adesivo
Adhesive profile



Profilo blisterato
Profile with blister

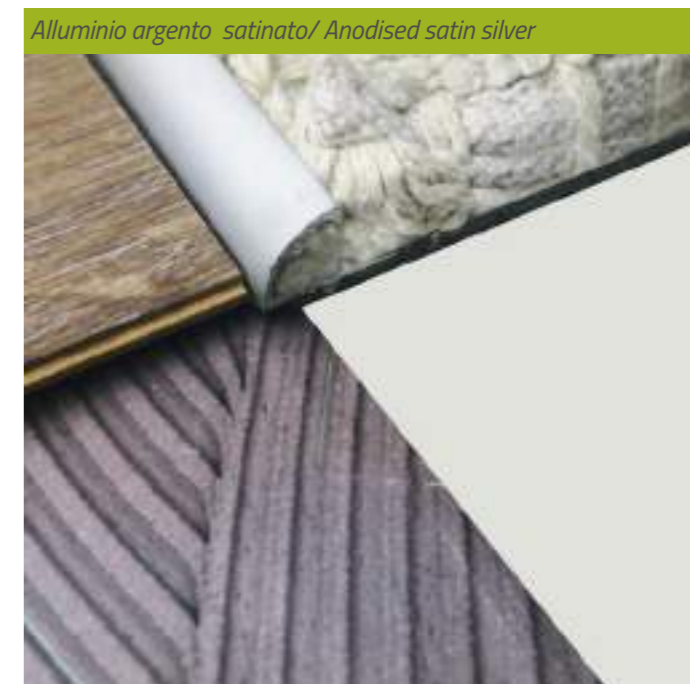

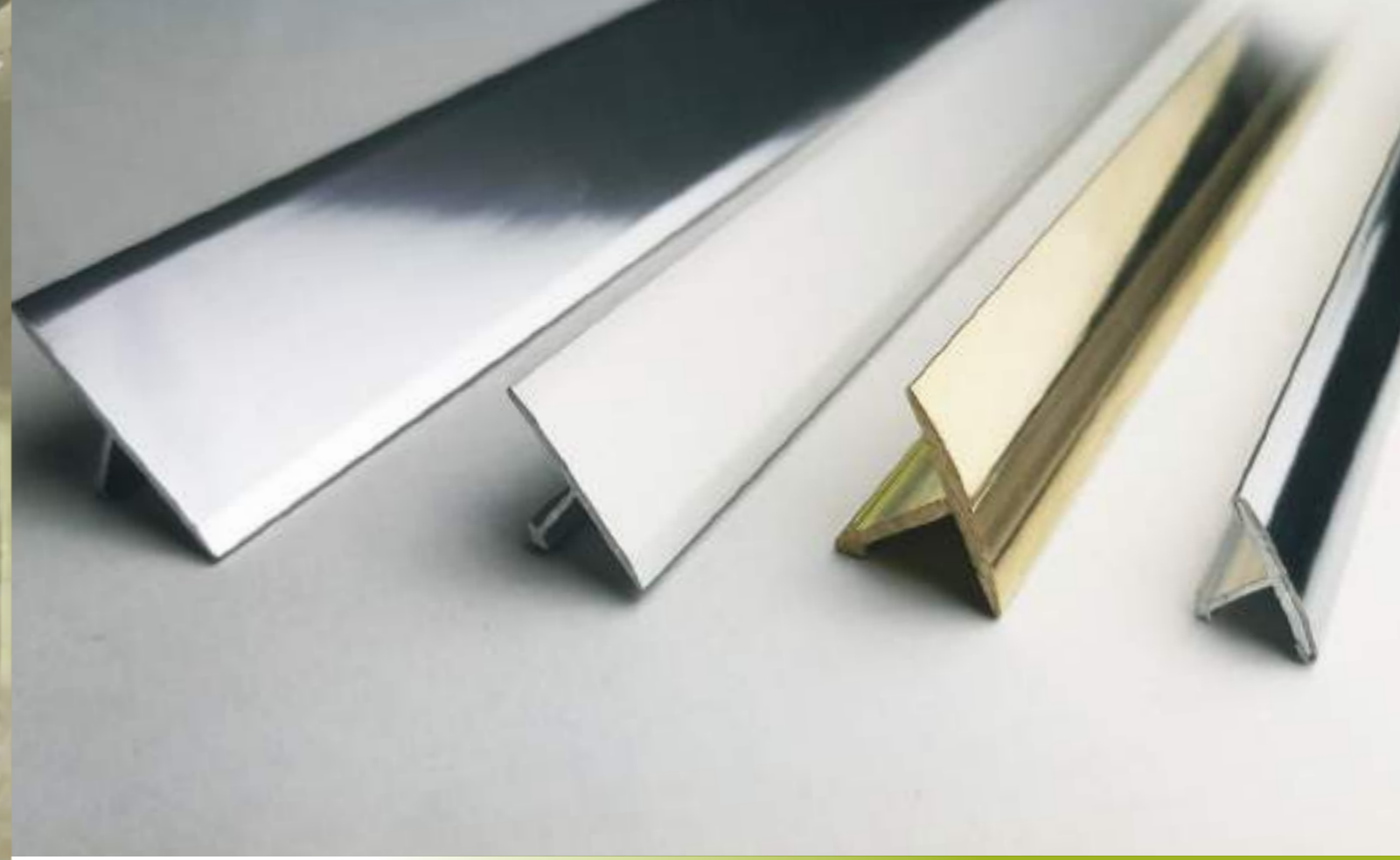

Giunti decorativi

Deco trimps/ Joints décoratifs/ Juntas decorativas

Il Giunto decorativo è un prodotto progettato per una giunzione ottimale di pavimenti di differente materiale o pavimenti di diversa natura e spessore e per nascondere le imperfezioni perimetrali. Il prodotto possiede anche una funzione estetica e decorativa grazie alla varietà di materiali degli articoli presenti in gamma, abbinabili alle finiture dei profili per il rivestimento e profili per fai da te. La struttura del giunto garantisce una perfetta resistenza sia ai movimenti di compressione che di trazione del pavimento. Finiture disponibili: Acciaio Inox aisi 304, ottone, alluminio

Vantaggi:

- Altamente decorativo
- Resistenza ai graffi
- Resistenti al calpestio
- Scarsa manutenzione
- La loro applicazione consente l'utilizzo di diversi pavimenti
- Ampia gamma di colori

Arcansas' decorative trims are designed for the best junction of floorings from different material or thickness, thanks to their ability to hide perimetrical imperfections. The result is not only functional, but also beautiful thanks to the wide range of materials. All decorative trims can be matched with covering profiles and DIY profiles of the same finishing. Available finishings: AISI 304 Stainless-steel, brass-aluminium

Strong points:

- Highly decorative
- Resistant to foot traffic
- Applicable to different kind of floorings
- Easy application thanks to screws or glue/adhesive tape
- Little maintenance is required
- Wide range of colours

Le joint décoratif est un produit conçu pour la jonction optimale des sols de différents matériaux ou de sols de nature et d'épaisseur différente ainsi que pour masquer les imperfections du périmètre. Le produit facile à appliquer (avec vis ou colle/adhésif) a également une fonction esthétique et décorative grâce à la variété des matériaux des articles de la gamme qui peuvent être combinés avec les finitions des profilés pour le revêtement et des profilés pour le bricolage. La structure du joint garantit une résistance parfaite aux mouvements de compression et de traction du sol. Finitions disponibles : acier inoxydable AISI 304, laiton, aluminium

Avantages:

- Très décoratif
- Résistance aux rayures
- Résistant au piétinement
- Faible entretien
- Leur application permet l'utilisation de différents sols
- Large gamme de couleur

La junta decorativa es un producto diseñado para una precisa junta de suelos de diferentes materiales o suelos de diferentes naturaleza y espesor y para disimular imperfecciones perimetrales. El producto también tiene una función estética y decorativa gracias a la variedad de materiales de los artículos de la gama, que se pueden combinar con los acabados de los perfiles para el revestimiento y perfiles para bricolaje. La estructura de la junta garantiza una perfecta resistencia tanto a los movimientos de compresión como a los de tracción del suelo. Acabados disponibles: acero inoxidable AISI 304, latón, aluminio

Ventajas:

- Altamente decorativo
- resistente al tráfico peatonal
- resistencia al rayado
- Fácil aplicación (con tornillos o pegamento/adhesivo)
- Se necesita de poco mantenimiento
- Amplia gama de colores



TIACCIAIO	Finitura- Finish	Range di applicazione	BxH. (mm)	EAN	Cod.	BxH. (mm)	L. (m)	Conf. - Carton	Min. ord.
	acciaio inox lucido AISI 304		14 x 9	8013237053963	063H		2,70	10	5
	polished AISI 304 s.steel		14 x 9	8013237055066	063H1			0,90	10

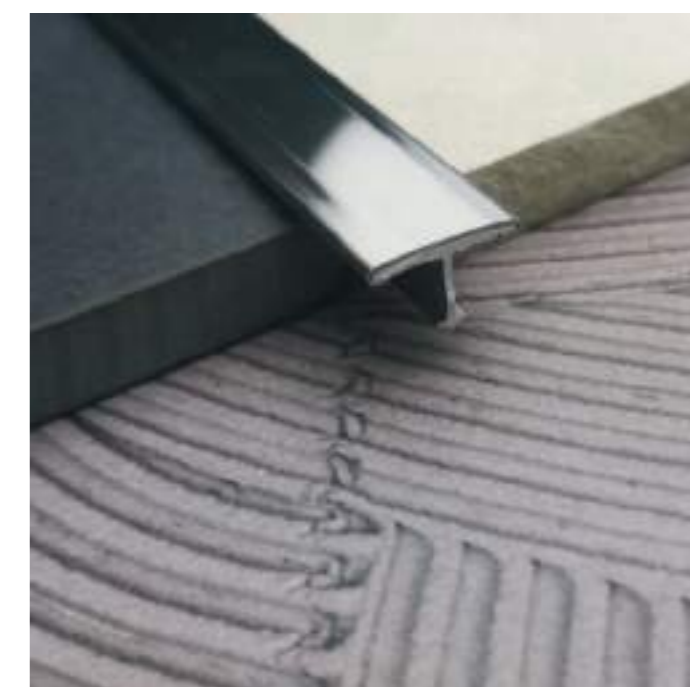
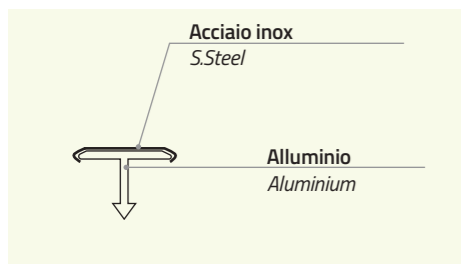
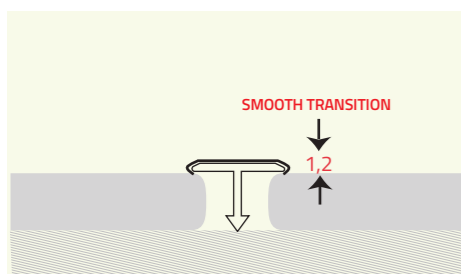
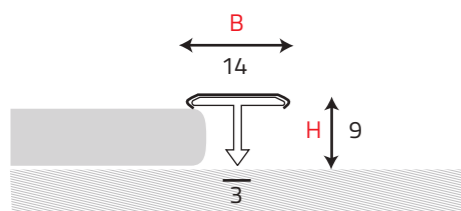

Profilo blisterato
Profile with blister

TI	Finitura- Finish	Range di applicazione	BxH. (mm)	EAN	Cod.	Caratteristiche	L. (m)	Conf. - Carton	Min. ord.
	 ottone satinato satin brass		14 x 9	8013237500634	063		2,70	10	5
			14 x 9	8013237000646	064		0,90	10	5
	 ottone naturale natural brass		14 x 9	8013237009595	063B		2,70	10	5
			14 x 9	8013237064129	064A2		0,90	10	5

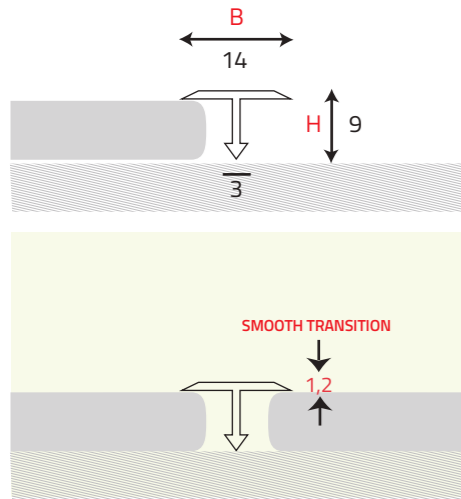



Ottone naturale/ Natural brass

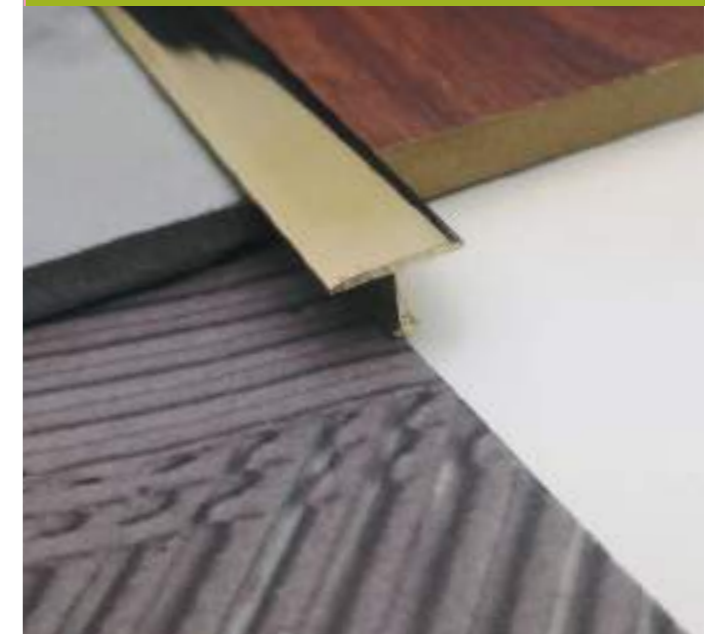

Ottone lucido/ Polished brass

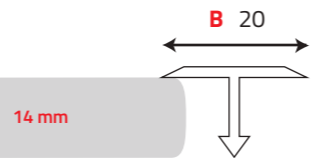

Profilo blisterato
Profile with blister

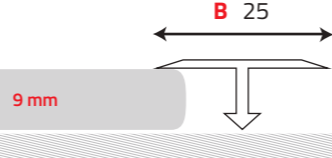
TIMAGNUM	Finitura- Finish	Range di applicazione	BxH. (mm)	EAN	Cod.	Caratteristiche	L. (m)	Conf. - Carton	Min. ord.
	 ottone naturale natural brass		14 mm						
	 ottone lucido polished brass								
	 ottone cromato chrome brass		9 mm						

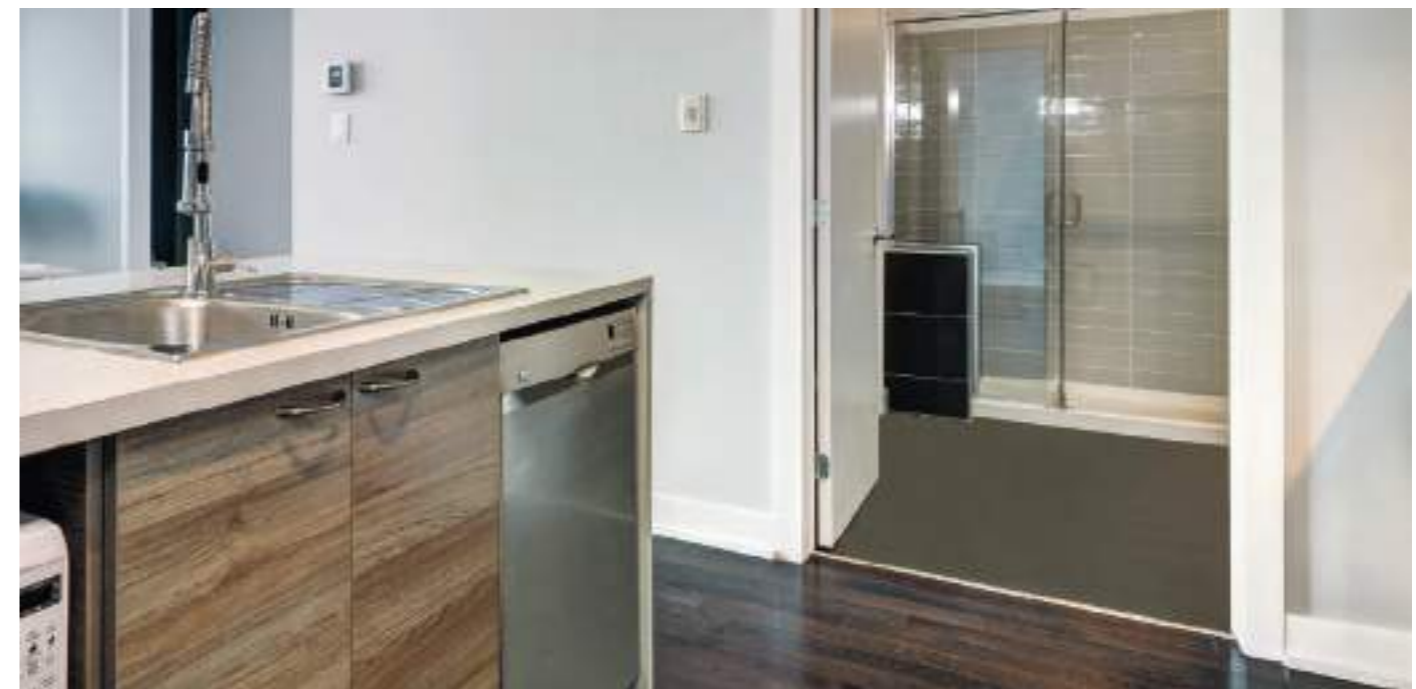
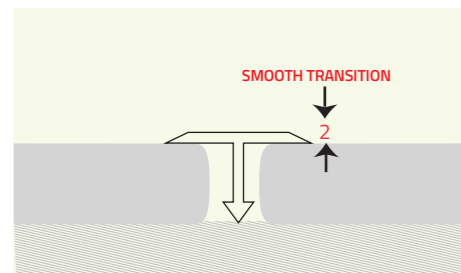
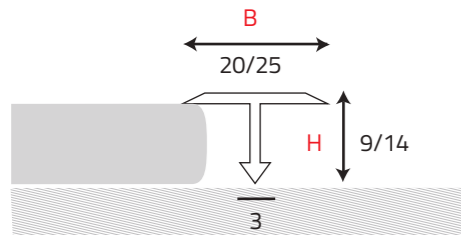











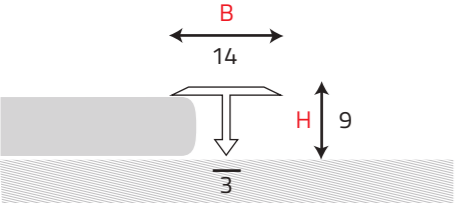
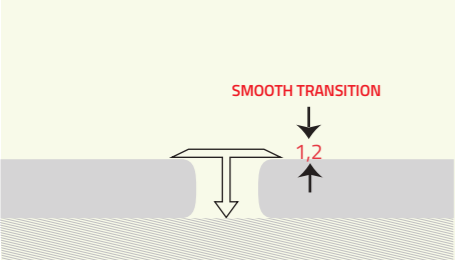

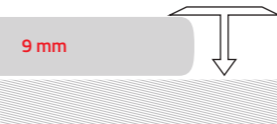









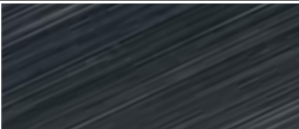

Ottone lucido/ Polished brass

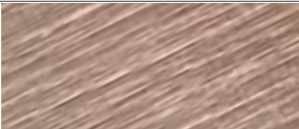

Ottone cromato/ Chrome brass

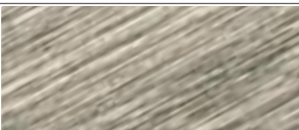

Profilo blisterato
Profile with blister

TIALU	Finitura- Finish	Range di applicazione	BxH. (mm)	EAN	Cod.	Caratteristiche	L. (m)	Conf. - Carton	Min. ord.
  	 argento anodizzato satinato anodised satin silver		14 x 9	8013237036362	063A5/90 		2,70	30	5
			14 x 9	8013237085124	063A2/90		1,80	30	5
			14 x 9	8013237053475	063A6/90 	 	0,90	30	5
	 argento anodizzato lucido polished anodised silver		14 x 9	8013237026165	063A1/93 		2,70	30	5
			14 x 9	8013237053499	063A4/93 	 	0,90	30	5
			 nero anodizzato spazzolato brushed anodised black	14 x 9	8013237072971	063A5/63		2,70	30
	14 x 9			8013237070960	063A4/63	 	0,90	30	5
	 ramato anodizzato spazzolato brushed anodised copper			14 x 9	8013237070953	063A4/99S	 	0,90	30
			 titanio anodizzato spazzolato brushed anodised titanium	14 x 9	8013237072988	063A5/96		2,70	30
	14 x 9			8013237070946	063A4/96 	 	0,90	30	5



Profilo blisterato
Profile with blister





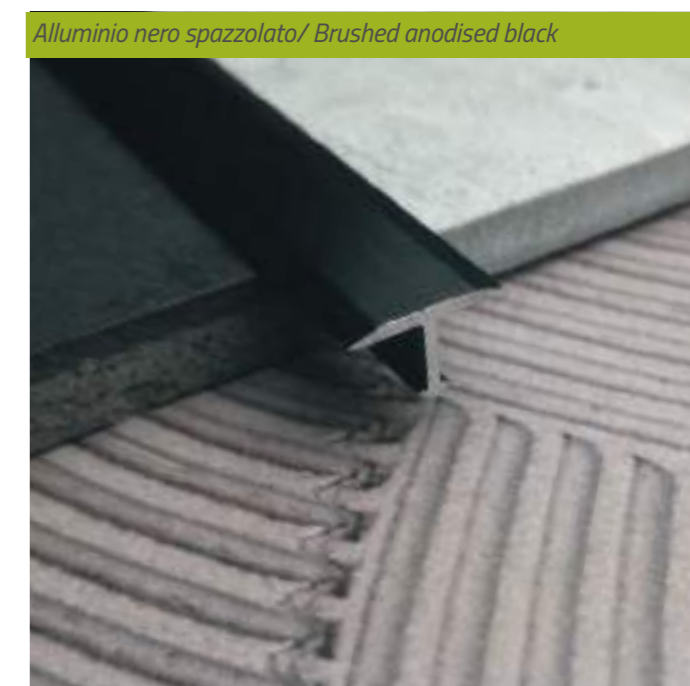



Alluminio argento satinato/ Anodised satin silver

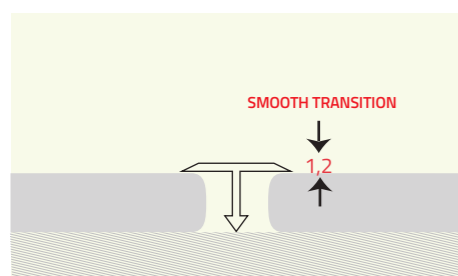
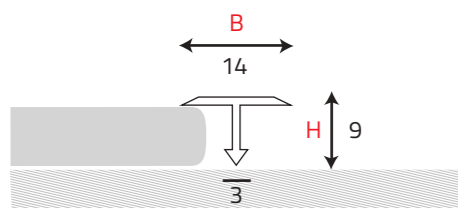
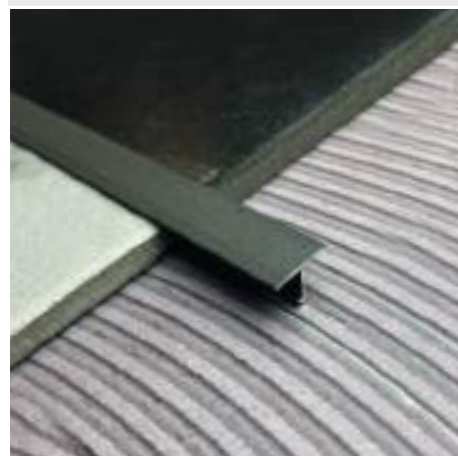





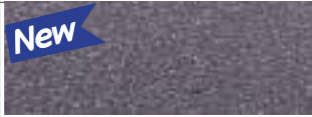

Alluminio nero spazzolato/ Brushed anodised black

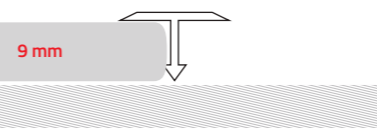
TI ALU



New		verniciato effetto pietra ruggine stone finishing painting rust
New		verniciato effetto pietra beige stone finishing painting beige
New		verniciato effetto pietra sabbia stone finishing painting sand
New		verniciato effetto pietra cemento stone finishing painting concrete
New		verniciato effetto pietra fumo di Londra stone finishing painting London
New		verniciato effetto pietra antracite stone finishing painting anthracite



BxH. (mm)	EAN	Cod.	Caratteristiche	L (m)	Conf. Carton.	Ord.min
14 x 9	8013237149246	063A/100		0,90	10	5
14 x 9	8013237150273	063A5/100		2,70	10	5
14 x 9	8013237149253	063A/101		0,90	10	5
14 x 9	8013237150280	063A5/101		2,70	10	5
14 x 9	8013237149260	063A/102		0,90	10	5
14 x 9	8013237150297	063A5/102		2,70	10	5
14 x 9	8013237149277	063A/103		0,90	10	5
14 x 9	8013237150303	063A5/103		2,70	10	5
14 x 9	8013237149284	063A/104		0,90	10	5
14 x 9	8013237150310	063A5/104		2,70	10	5
14 x 9	8013237149291	063A/105		0,90	10	5
14 x 9	8013237150266	063A5/105		2,70	10	5

 Perfect Matching

Catalogo profili fai da te/ DIY catalogue



Catalogo Ceramica/ Ceramic catalogue



Verniciato pietra fumo di Londra/ Stone finishing painting London

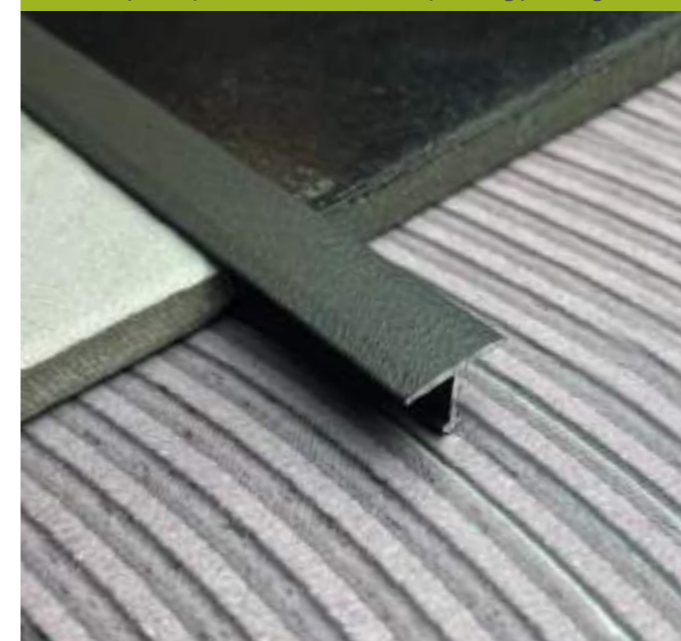

Verniciato pietra beige/ Stone finishing painting Beige



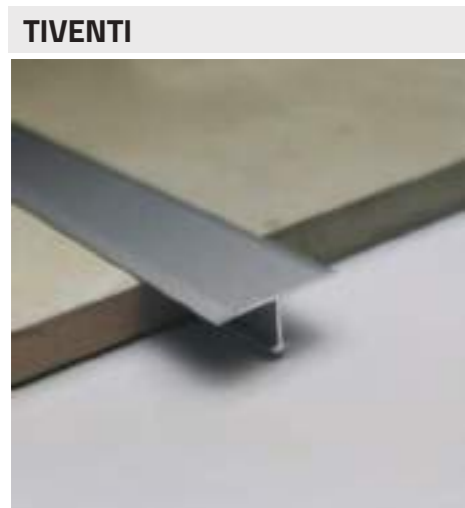

TIVENTI	Finitura- Finish	Range di applicazione	BxH. (mm)	EAN	Cod.	Caratteristiche	L. (m)	Conf. - Carton	Min. ord.
	argento anodizzato satinato anodised satin silver		20 x 9	8013237090029	063G/90		2,70	30	5
	oro anodizzato satinato satin anodised gold		20 x 9	8013237131685	063G3/90		0,90	30	5
			20 x 9	8013237090036	063G/91		2,70	30	5

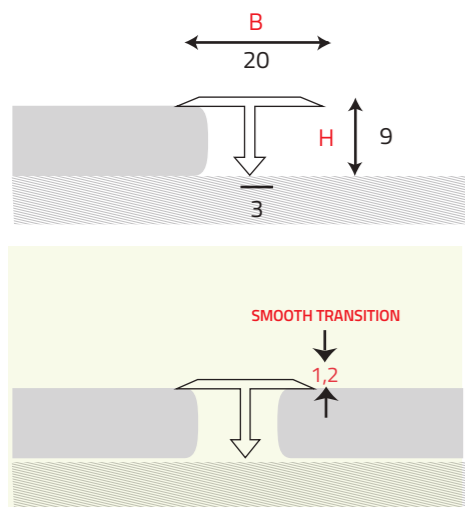

Profilo blisterato
Profile with blister

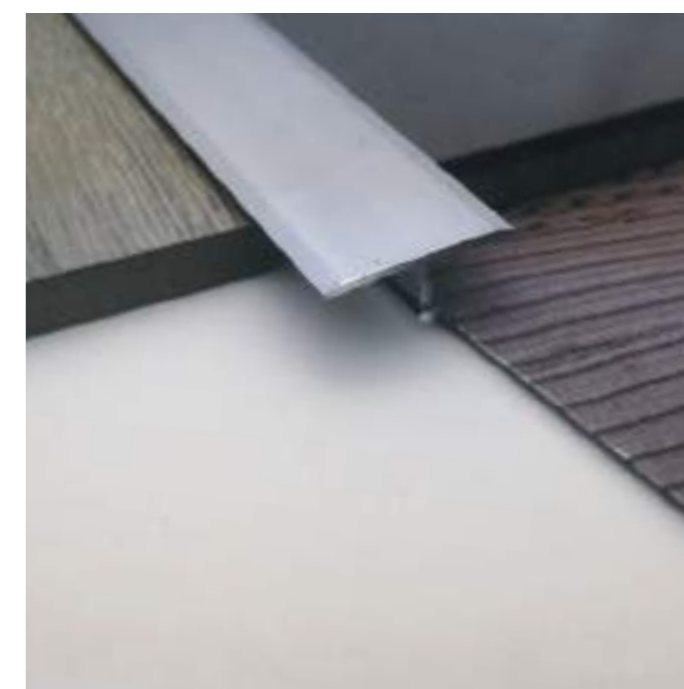



Finitura- Finish		Range di applicazione		EAN	Cod.	Caratteristiche	L. (m)	Conf. - Carton	Min. ord.		
	argento anodizzato satinato		30 x 9	8013237144111	063G6/90		2,70	30	5		
	anodised satin silver		30 x 9	8013237149178	063G7/90		0,90	30	5		
	argento anodizzato lucido										
	polished anodised silver										

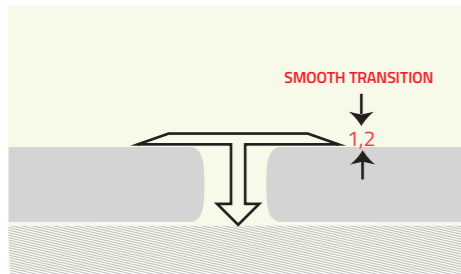
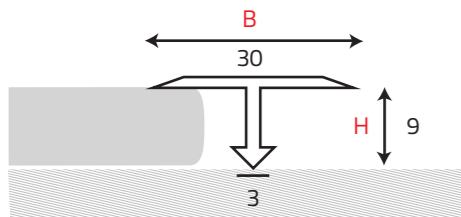



Alluminio argento lucido/ Polished anodised silver





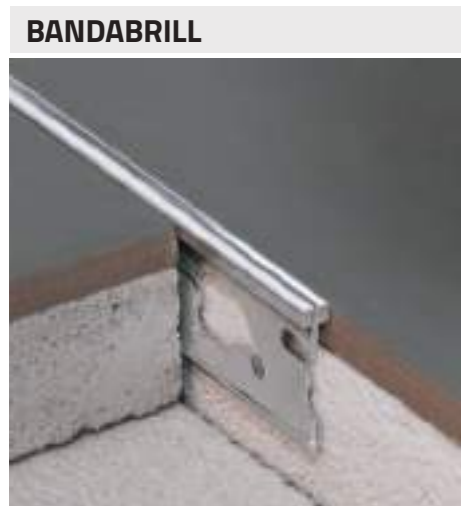

Alluminio argento satinato/ Anodised satin silver

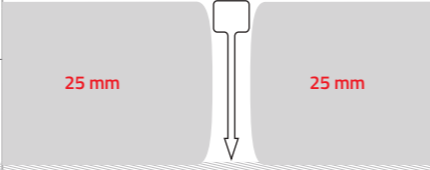

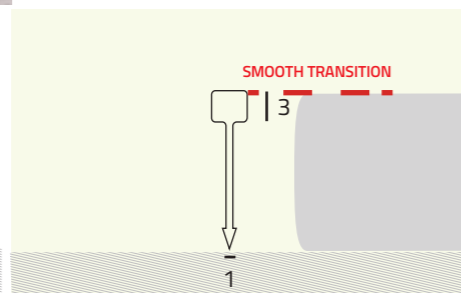
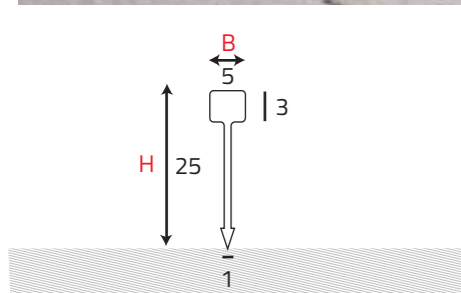

Finitura- Finish	Range di applicazione	BxH. (mm)	EAN	Cod.	Caratteristiche	L. (m)	Conf. Carton	Min. ord.	€/m	€/pz
 argento anodizzato lucido polished anodised silver		25 mm								
 oro anodizzato lucido polished anodised gold										

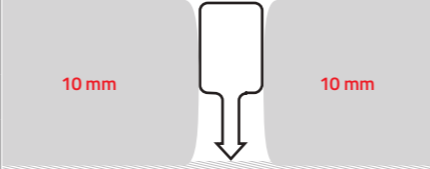

Finitura- Finish	Range di applicazione	BxH. (mm)	EAN	Cod.	Caratteristiche	L. (m)	Conf. - Carton	Min. ord.	€/m	€/pz
 argento naturale natural silver		4,5 x 10	8013237006686	054B 		2,70	10	5	3,36	9,06

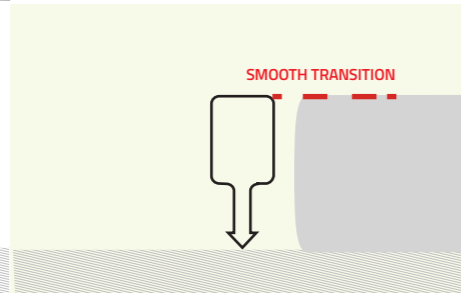
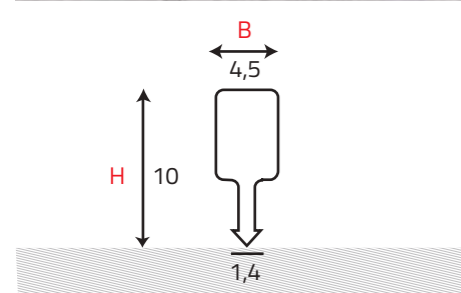

BANDELLA

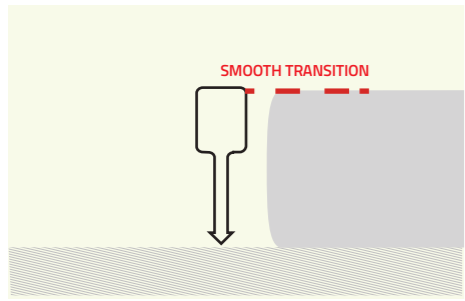
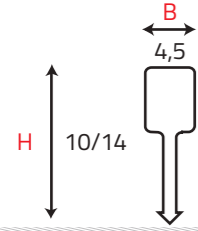

Finitura- Finish	Range di applicazione	BxH. (mm)	EAN	Cod.	Caratteristiche	L. (m)	Conf. - Carton	Min. ord.		
ottone naturale natural brass	10 mm	4,5 x 10	8013237005412	054A		0,90	10	5		
	14 mm									



Profilo blisterato
Profile with blister

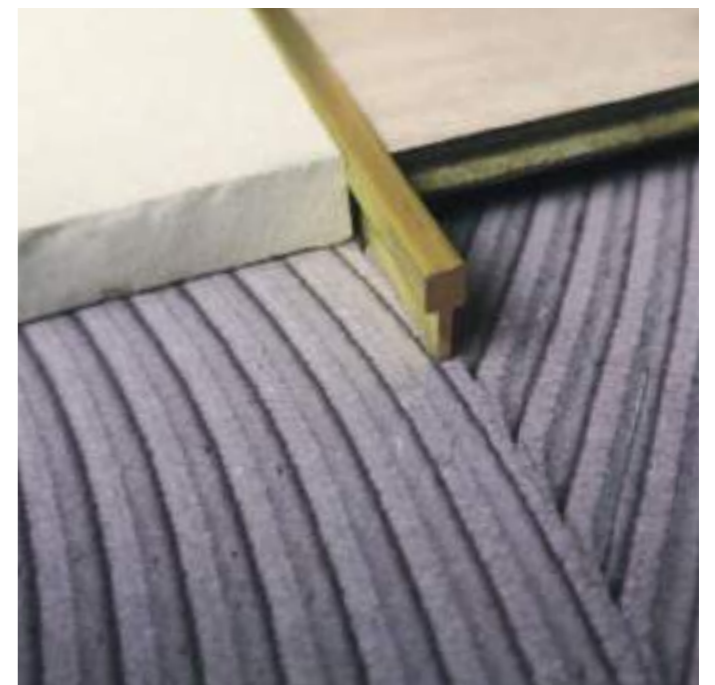
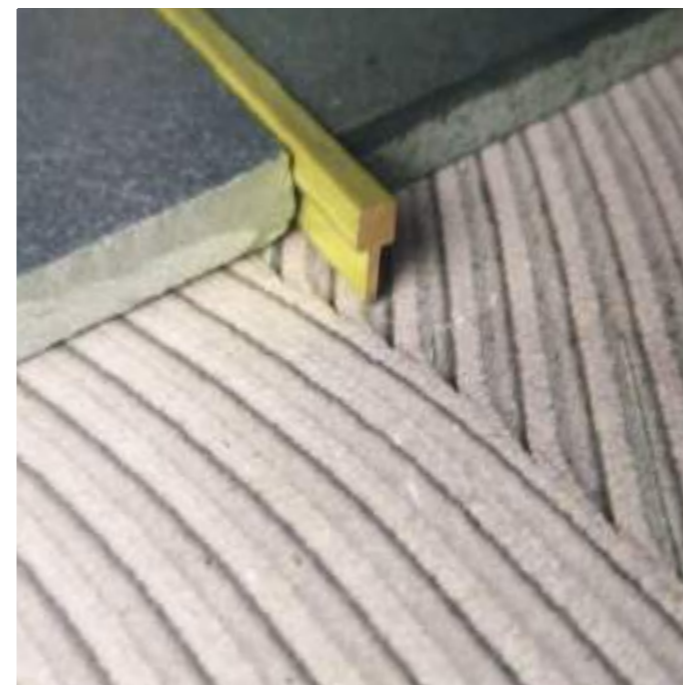

QUADRO RETTANGOLO

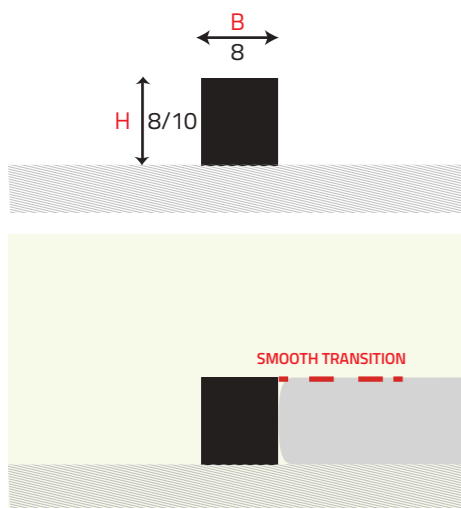

Finitura- Finish	Range di applicazione	BxH. (mm)	EAN	Cod.	Caratteristiche	L. (m)	Conf. - Carton	Min. ord.
 ottone naturale natural brass								
								

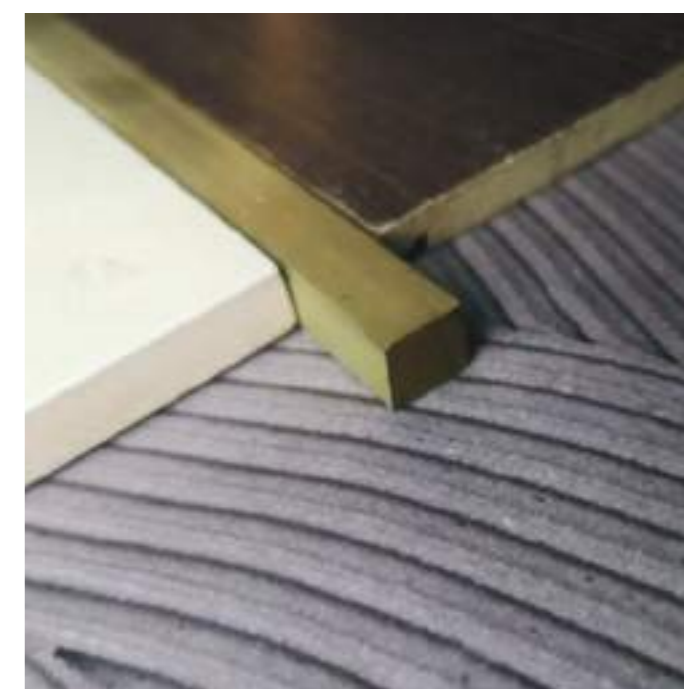

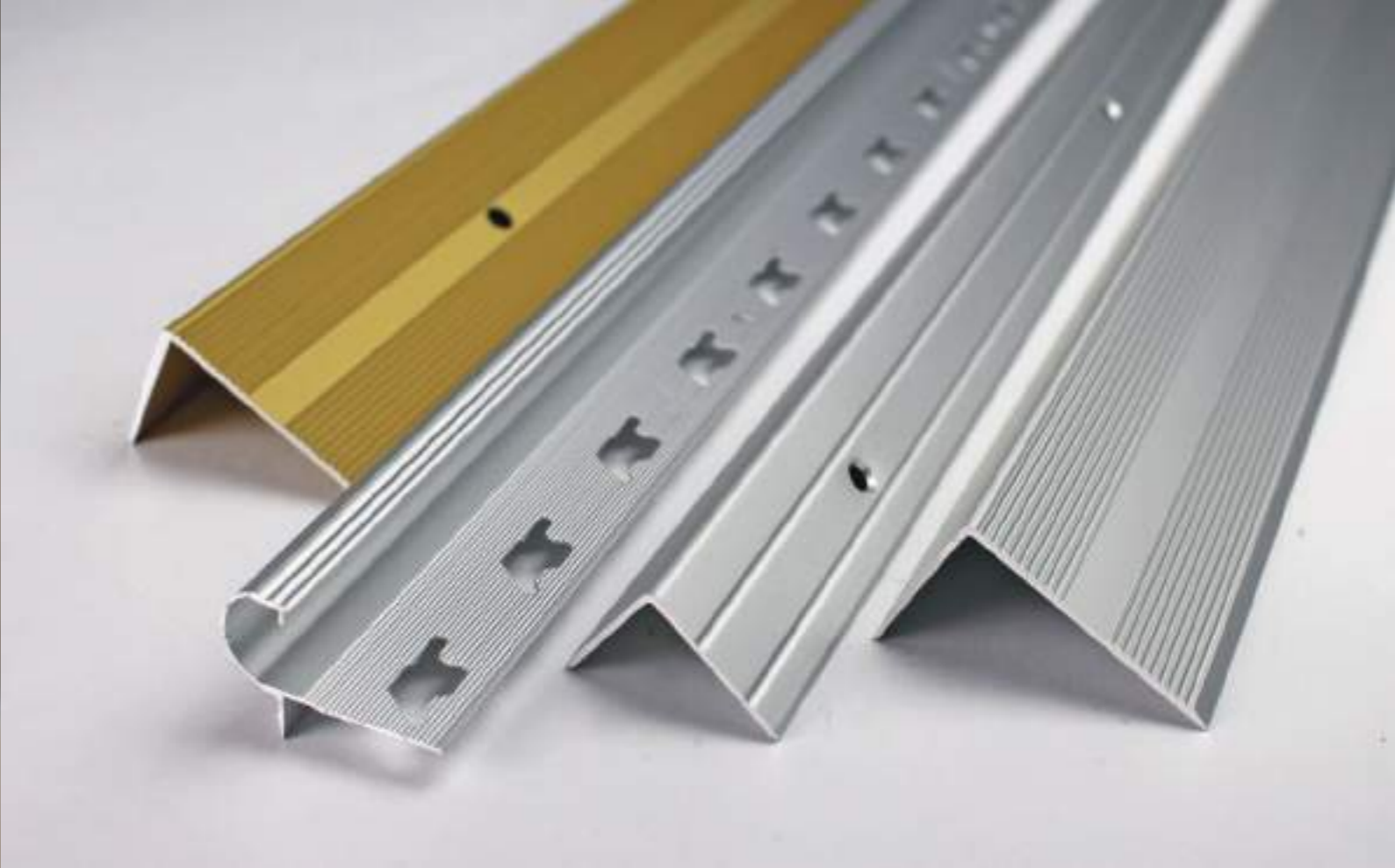

Paragradini

Stair Edges/ Nez de marche/ Nariz de escalera

I Paragradini Arcansas sono stati progettati per proteggere il bordo del gradino e nascondere la giunzione tra la pedata e l'alzata, il che ne fa a tutti gli effetti un vero e proprio elemento d'arredo. Indispensabile per dare un tocco di design all'ambiente e per migliorare la salita e la discesa delle scale.

La sua linea moderna ed essenziale fa sì che i gradini acquistino una nuova luce, donando all'intera struttura un risultato estetico ad alto impatto visivo. La praticità del prodotto consente un utilizzo rapido e semplice anche ai neofiti del 'fai da te', senza dover ricorrere ai professionisti del settore. Finiture disponibili: Acciaio Inox aisi 304, Ottone, Alluminio, pvc

Vantaggi:

- Altamente decorativi e pratici
- Resistenti al calpestio
- Scarsa manutenzione
- La loro applicazione con viti o adesivo garantisce alla struttura un impiego stabile e continuativo

Arcansas' stair nosing are designed to protect stair edges and hide the junction between the riser and the tread, but with the result of a design element in any case of application. This product is essential to give a design touch to the setting of application and to empower the safety in the ascent and descent of the stairs. The essential and modern style of the product let the stairs gain a new light, giving an high aesthetical impact to the whole structure. The advantage comes also from the easiness and fastness of application, so anybody can make the application himself/herself without the aid of professionals.

Available finishings: AISI 304 Stainless-steel, brass, aluminium, PVC

Strong points:

- Highly decorative
- Resistant to foot traffic
- Easy application thanks to screws or glue/adhesive tape, with a long-lasting and stable result
- Little maintenance is required

Le nez de marche Arcansas a été conçu pour protéger le bord de la marche et cacher la jonction entre le giron et la contremarche, ce qui en fait un véritable complément d'ameublement. Indispensable pour donner une touche de design à l'environnement et pour améliorer la montée et la descente des escaliers. Sa ligne moderne et essentielle donne aux marches une nouvelle lumière, donnant à l'ensemble de la structure un résultat esthétique au fort impact visuel. La praticité du produit permet une utilisation rapide et facile même pour les débutants en bricolage, sans avoir à recourir à des professionnels du secteur.

Finitions disponibles : acier inoxydable AISI 304, laiton, aluminium, pvc

Avantages:

- Très décoratif et pratique
- Résistant au piétinement
- Faible entretien
- L'application avec des vis ou de la colle garantit une utilisation stable et permanente de la structure

Los perfiles para escalón Arcansas fue diseñado para proteger el borde del escalón y ocultar la unión entre la huella y la contrahuella, lo que en efecto lo convierte en un producto indispensable. Imprescindible para dar un toque de diseño al entorno y para mejorar la subida y bajada de escaleras. Su línea moderna y esencial asegura que los escalones adquieran un nuevo design, dando a toda la estructura un resultado estético de alto impacto visual. La practicidad del producto permite un uso rápido y sencillo incluso para los novatos del 'hágalo usted mismo', sin tener que recurrir a profesionales del sector. Acabados disponibles: acero inoxidable AISI 304, latón, aluminio, pvc

Finitions disponibles : acier inoxydable AISI 304, laiton, aluminium, pvc

Ventajas:

- Muy decorativo y práctico.
- Resistente al tráfico peatonal
- Se necesita de poco mantenimiento
- Su aplicación con tornillos o adhesivo garantiza a la estructura un uso estable y continuo

STOPINOX

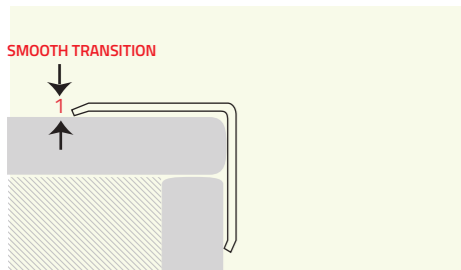
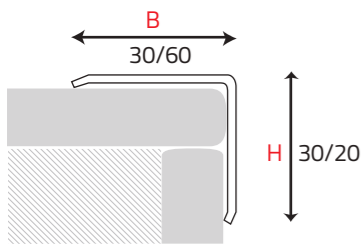
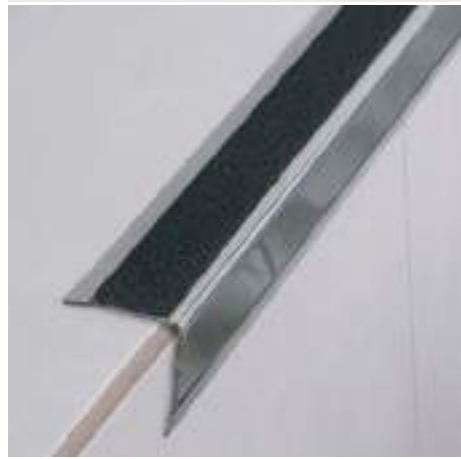

Finitura-Finish	Range di applicazione	BxH. (mm)	EAN	Cod.	Caratteristiche	L. (m)	Conf. - Carton	Min. ord.
acciaio inox lucido AISI 304 polished AISI 304 s.steel		30x30						
acciaio inox spazzolato AISI 304 brushed AISI 304 s.steel								
		60x20						



ANTISDRUCCIOLO ARCANSAS, CARATTERISTICHE FISICO-MECCANICHE
ARCANSAS ANTI-SLIP TAPE, PHYSICAL AND MECHANICAL CHARACTERISTICS

Supporto Tape material	Spessore Thickness	Superficie Antisdrucchio Non-Slip Surface	Forza di adesione Adhesion force	Allung. alla rottura Ultimate tensile strength	Temperatura d'esercizio Service temperature	Colore Colour
PVC	0,75 mm	Grani di Carborundum	5,8 N/cm	50%	-5+50°C	
PVC	0,75 mm	Grains of Carborundum	5,8 N/cm	50%	-5+50°C	



Profilo adesivo
Adhesive profile



Profilo con pellicola
Profile with film



Profilo blisterato
Profile with blister

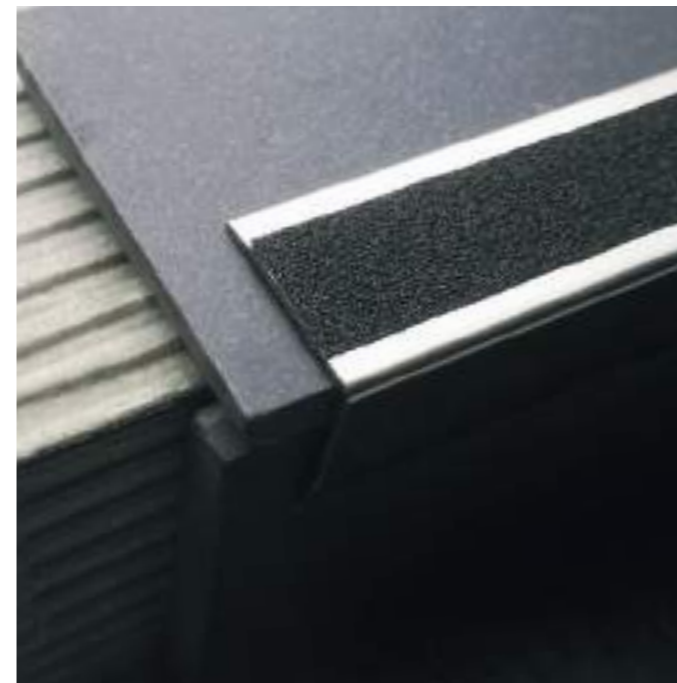



SLIPSTOP	Finitura-Finish	Range di applicazione	BxH. (mm)	EAN	Cod.	Caratteristiche	L. (m)	Conf. - Carton	Min. ord.
	 <p>ottone lucido polished brass</p>								

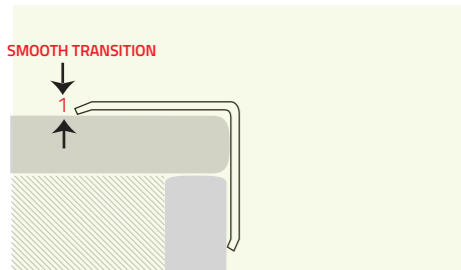
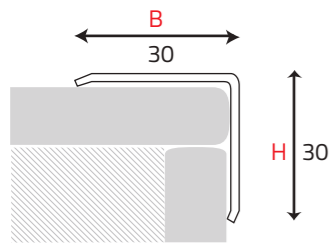

ANTISDRUCCIOLO ARKANSAS, CARATTERISTICHE FISICO-MECCANICHE
ARKANSAS ANTI-SLIP TAPE, PHYSICAL AND MECHANICAL CHARACTERISTICS

Supporto Tape material	Spessore Thickness	Superficie Antisdrucchio Non-Slip Surface	Forza di adesione Adhesion force	Allung. alla rottura Ultimate tensile strength	Temperatura d'esercizio Service temperature	Colore Colour
PVC PVC	0,75 mm 0,75 mm	Grani di Carborundum Grains of Carborundum	5,8 N/cm 5,8 N/cm	50% 50%	-5+50° C -5+50° C	



Profilo adesivo
Adhesive profile

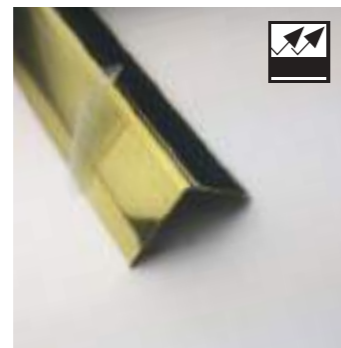







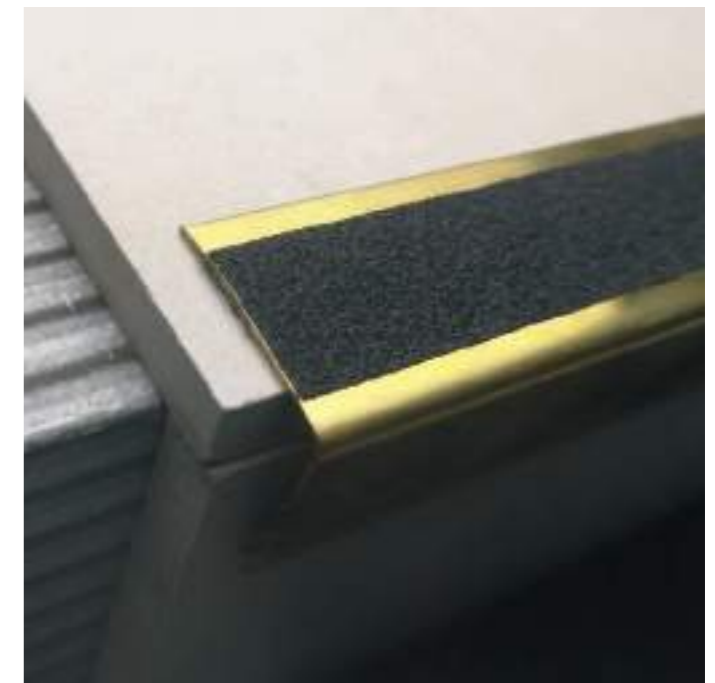
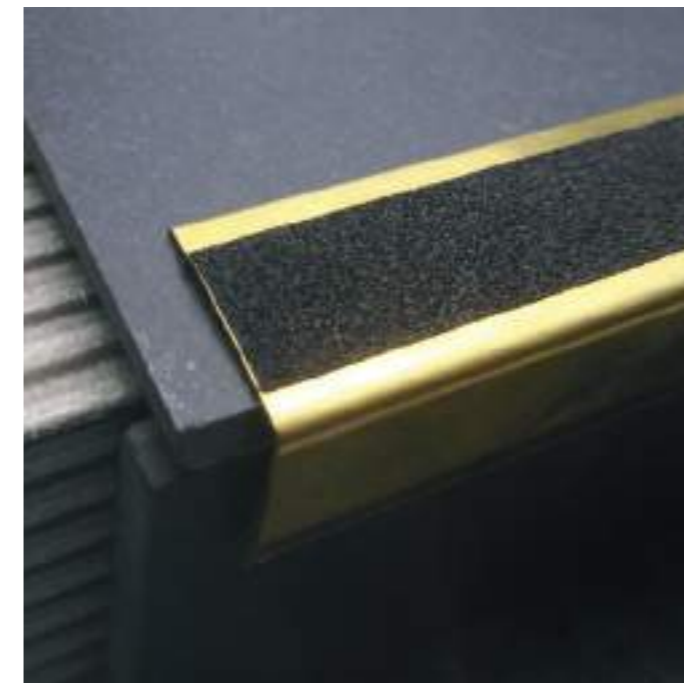

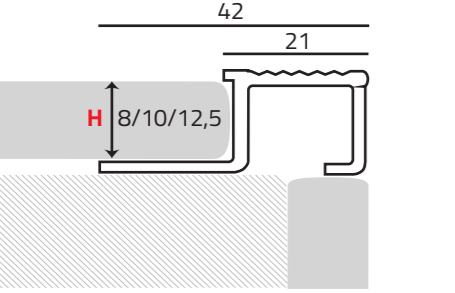
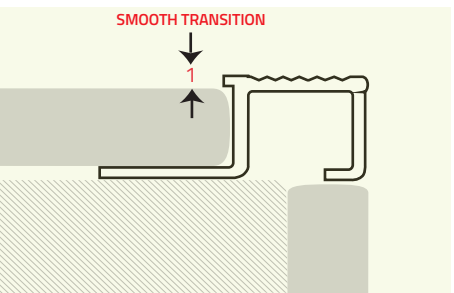







Profilo con pellicola
Profile with film



Profilo blisterato
Profile with blister



PARAGRALL	Finitura-Finish	Range di applicazione	H.(mm)	EAN	Cod.	Caratteristiche	L. (m)	Conf. - Carton	Min. ord.
  	 argento naturale natural silver	 8 mm	10	8013237048839	045P		2,70	30	5
	 argento anodizzato satinato satin anodised silver	 10 mm	10	8013237048846	045P/90 		2,70	30	5
			10	8013237080631	045P1/90	 	0,90	30	5
			12,5	8013237052331	045T/90 		2,70	30	5
			12,5	8013237138462	045T2/90		0,90	30	5
	 oro anodizzato satinato anodised satin gold	 12,5 mm							
	 bronzo anodizzato satinato anodised satin bronze								



Profilo blisterato
Profile with blister

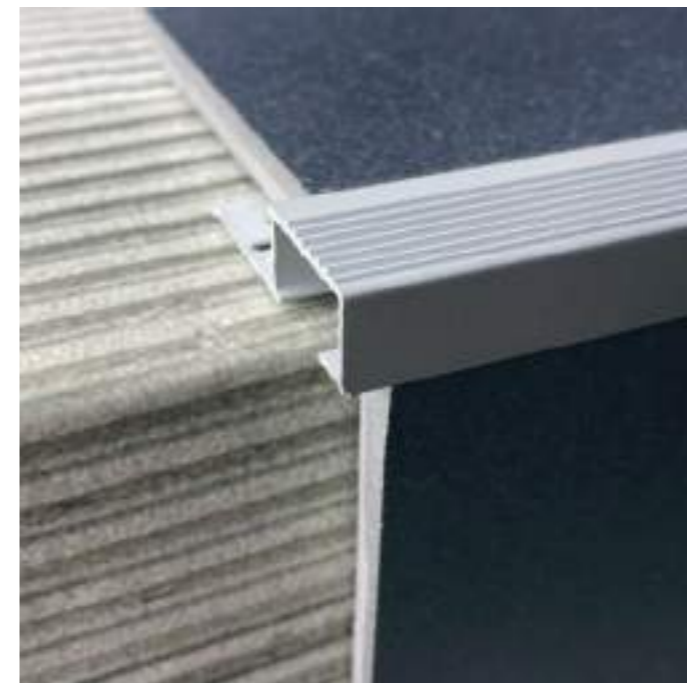

SAVESTEP

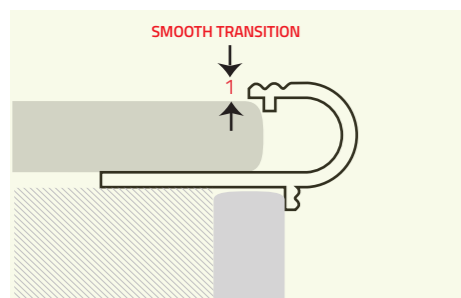
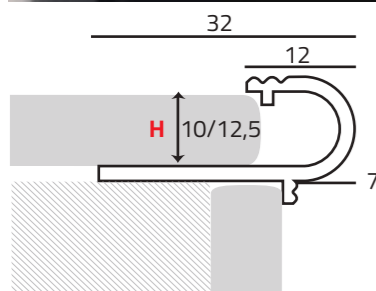

Finitura- Finish	Range di applicazione	H.(mm)	EAN	Cod.	Caratteristiche	L. (m)	Conf. - Carton	Min. ord.				
argento naturale natural silver		10	8013237035419	045M		2,70	30	5				
		10	8013237035426	045M/90								
argento anodizzato satinato satin anodised silver		10	8013237085391	045M2/90						0,90	30	5
		12,5	8013237133696	045M3/90						2,70	30	5



Profilo blisterato
Profile with blister

PARAGRAD	Finitura-Finish	Range di applicazione	BxH.(mm)	EAN	Cod.	Caratteristiche	L. (m)	Conf. - Carton	Min. ord.
	argento anodizzato satinato satin anodised silver		42 x 26	8013237005511	046C5A/90 FR		2,70	30	5
			42 x 26	8013237005481	046C5/90		2,70	30	5
			42 x 26	8013237054311	046C51/90		1,80	30	5
	42 x 26		8013237463137	046C13/90 FR		0,90	30	5	
	42 x 26		8013237081034	046C17/90		1,00	30	5	
	42 x 26		8013237463410	046C13/91		0,90	30	5	
oro anodizzato satinato anodised satin gold									
bronzo anodizzato satinato anodised satin bronze									

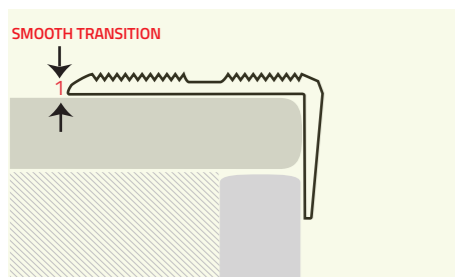
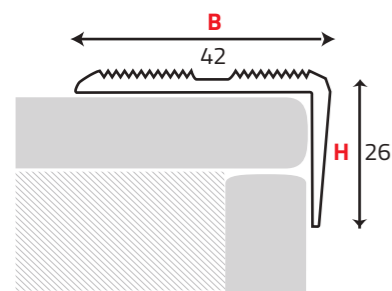

Profilo adesivo
Adhesive profile





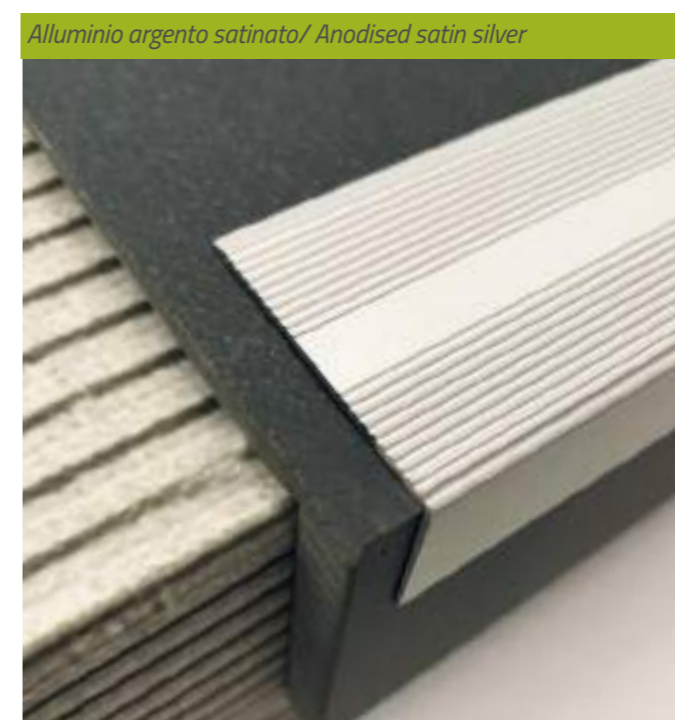



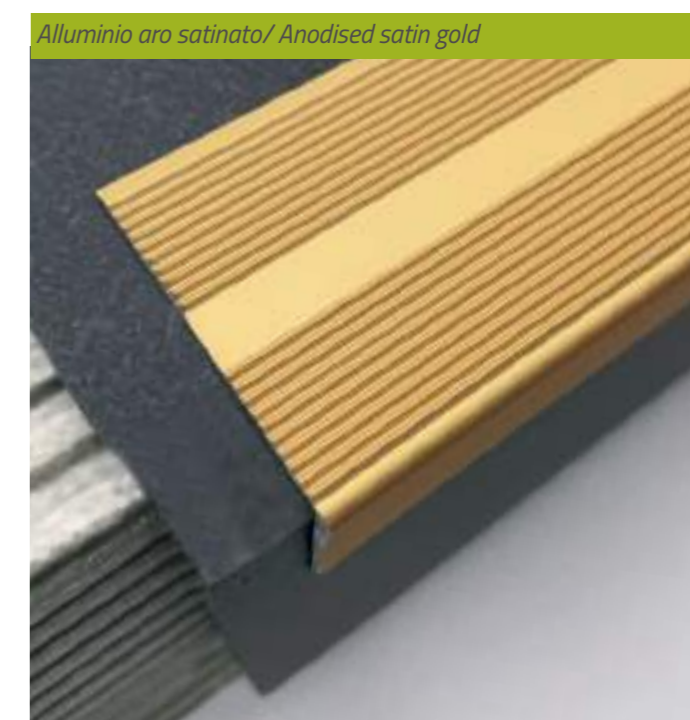



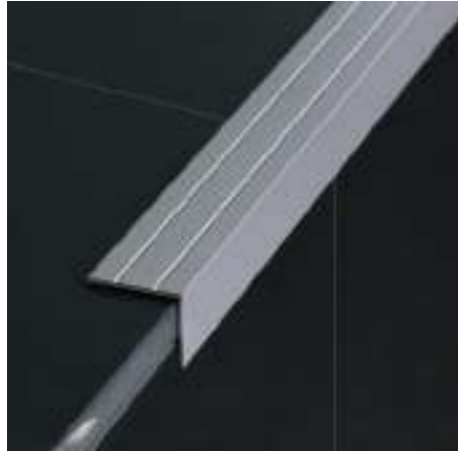
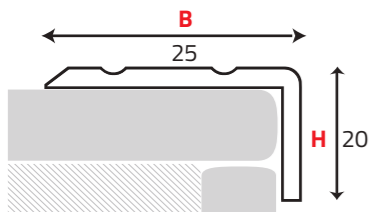
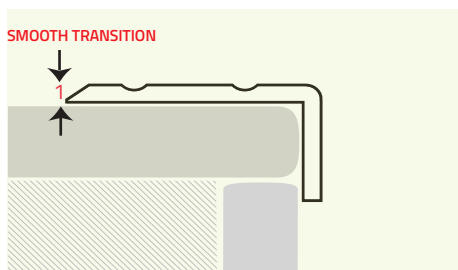

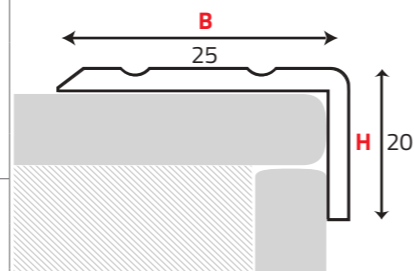





Profilo blisterato
Profile with blister



Alluminio argento satinato/ Anodised satin silver



Alluminio oro satinato/ Anodised satin gold

DECORGRALL	Finitura-Finish	Range di applicazione	BxH.(mm)	EAN	Cod.	Caratteristiche	L. (m)	Conf. - Carton	Min. ord.	
  	 argento anodizzato satinato satin anodised silver		25 x 20	8013237071509	045E1/90		2,70	30	5	
			25 x 20	8013237004941	045A/90 	 	2,70	30	5	
			25 x 25	8013237052164	045D1/90	 	2,70	30	5	
	25 x 20		8013237059941	045A1/90		1,80	30	5		
	25 x 20		8013237053482	045G/90 	  	0,90	30	5		
	25 x 20		8013237060770	045D3/90	 	1,00	30	5		
	25 x 20		8013237053512	045G/91	  	0,90	30	5		
			oro anodizzato satinato anodised satin gold							
			bronzo anodizzato satinato anodised satin bronze							

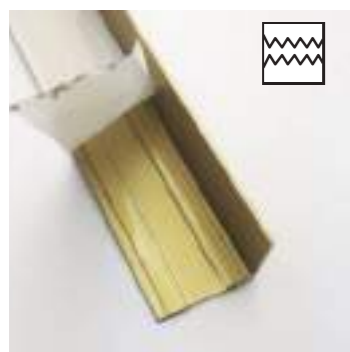

Profilo adesivo
Adhesive profile



Profilo forato con viti incluse
Drilled profile with screws included



Profilo blisterato
Profile with blister

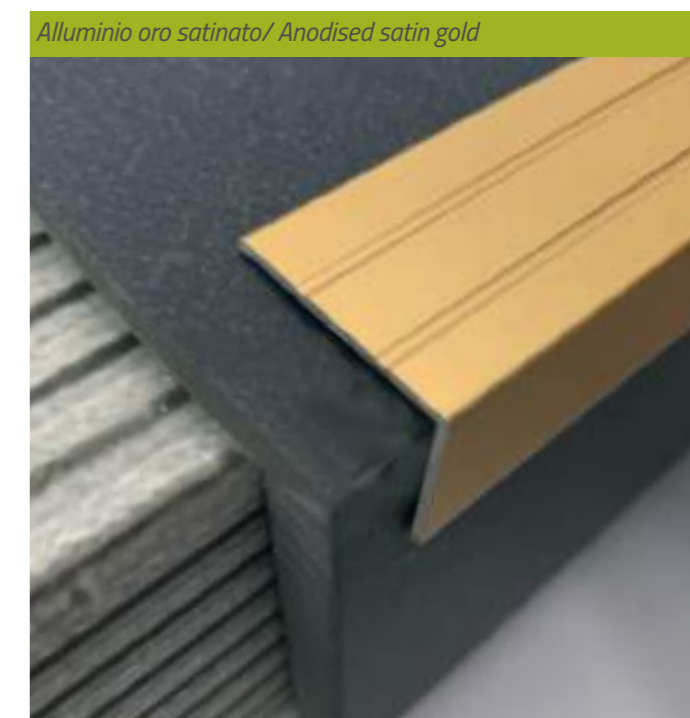
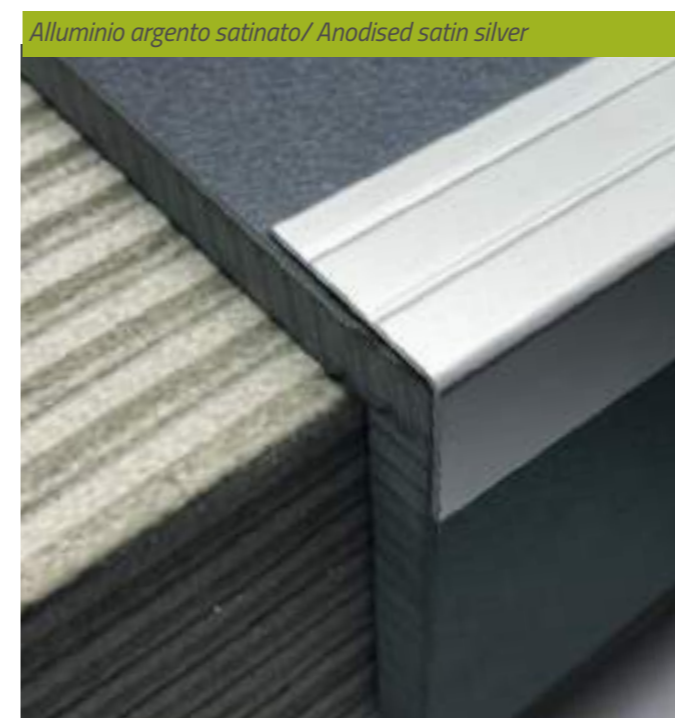

ALUSTEP



Finitura-Finish		Range di applicazione	EAN	Cod.	Caratteristiche	L. (m)	Conf. - Carton	Min. ord.	
	alluminio + PVC nero		10	8013237003302	009M6/70		2,70	30	5
	aluminium + PVC black		10	8013237060350	009M6A/70				
	alluminio + PVC marrone								
	aluminium + PVC brown								

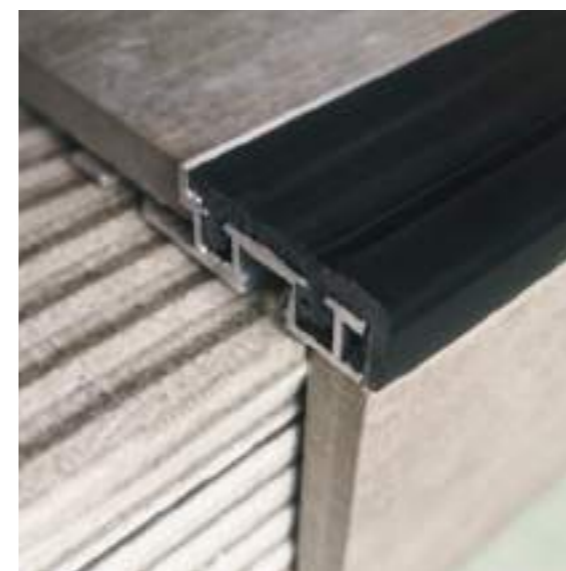
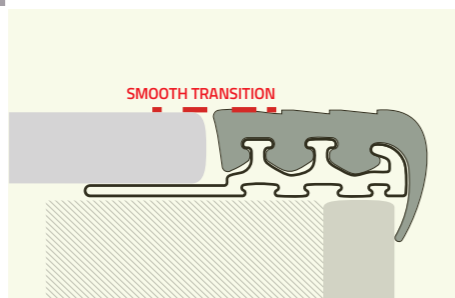
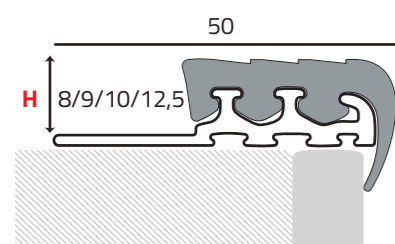

PIVUSTEP



Finitura-Finish		Range di applicazione	EAN	Cod.	Caratteristiche	L. (m)	Conf. - Carton	Min. ord.	
	PVC + PVC nero		10	8013237003258	009M2/70		2,70	30	5
	PVC + PVC black		10	8013237074821	009M22/70				

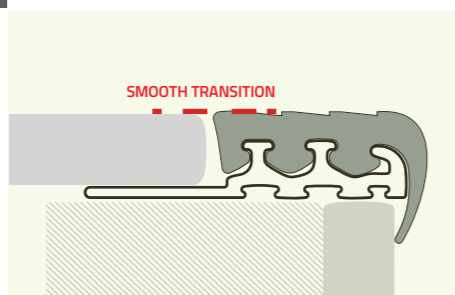
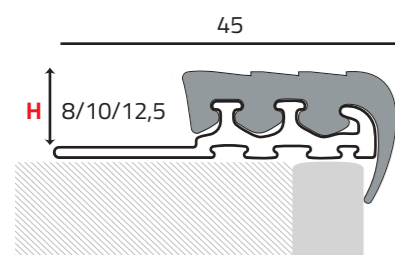

Profilo blisterato
Profile with blister

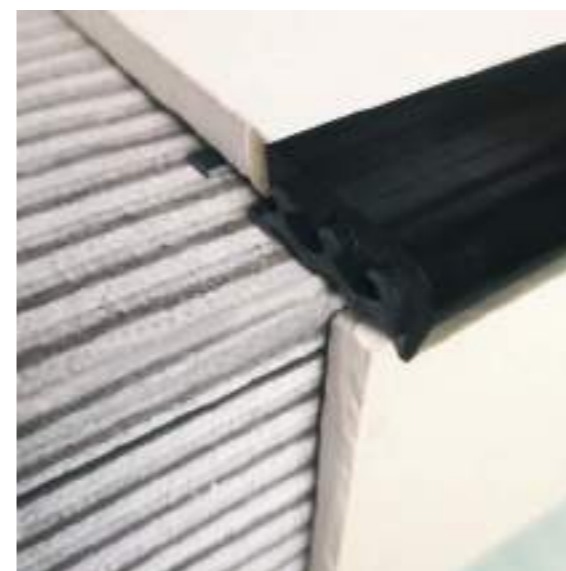

Fissa ed arreda elegantemente le guide che eliminano il rumore da calpestio in scale e corridoi

Fixes and furnishes pleasantly your stair-carpets which eliminate the noise made from walking on stairs and corridors



Finitura - finish		Caratteristiche	Cod.	EAN	Ø	L. (m)	Min. ord.
ottone lucido	polished brass						

Finitura - finish		Caratteristiche	Cod.	EAN	Ø	L. (m)	Min. ord.
ottone lucido							
polished brass							

Finitura - finish		Caratteristiche	Cod.	EAN	Ø	L. (m)	Min. ord.
ottone lucido							
polished brass							

Finitura - finish		Caratteristiche	Cod.	EAN	Ø	L. (m)	Min. ord.
ottone lucido							
polished brass							



Finitura - finish		Caratteristiche	Cod.	EAN	Ø	L. (m)	Min. ord.
ottone lucido							
polished brass							



Finitura - finish		Caratteristiche	Cod.	EAN	Ø	L. (m)	Min. ord.
ottone lucido							
polished brass							



Finitura - finish		Caratteristiche	Cod.	EAN	Ø	L. (m)	Min. ord.
ottone lucido	polished brass						



Finitura - finish		Caratteristiche	Cod.	EAN	Ø	L. (m)	Min. ord.
oro anodizzato							
anodised gold							







Finitura - finish		Caratteristiche	Cod.	EAN	Ø	L. (m)	Min. ord.
ottone lucido							
polished brass							



OCCHIOLO								
Finitura - finish	Caratteristiche	Cod.	EAN	Ø	L. (m)	Min. ord.		
ottone lucido polished brass								
								



COMPLETALU		blister = 2pz./pcs						
Finitura - finish	Caratteristiche	Cod.	EAN	Ø	L. (m)	Min. ord.		
oro anodizzato anodised gold	 							
								



TUBOALU								
Finitura - finish	Caratteristiche	Cod.	EAN	Ø	L. (m)	Min. ord.		
oro brillantato polished gold								
								







OCCHIOLO								
Finitura - finish	Caratteristiche	Cod.	EAN	Ø	L. (m)	Min. ord.		
ottone lucido polished brass								
								

COMPLETALU		2pz./pcs						
Finitura - finish	Caratteristiche	Cod.	EAN	Ø	L. (m)	Min. ord.		
oro brillantato polished gold	     							
								

TUBOALU								
Finitura - finish	Caratteristiche	Cod.	EAN	Ø	L. (m)	Min. ord.		
argento cromato chrome silver		1103/93	8013237511036	12	2,00	5		
								

TESTINALU								
Finitura - finish	Caratteristiche	Cod.	EAN	Ø	L. (m)	Min. ord.		
ottone cromato polished brass								
								

OCCHIOLICROM								
Finitura - finish	Caratteristiche	Cod.	EAN	Ø	L. (m)	Min. ord.		
ottone cromato polished brass								
								

COMPLETCROM								
Finitura - finish	Caratteristiche	Cod.	EAN	Ø	L. (m)	Min. ord.		
argento cromato chrome silver	     							
								





Nastro Antisdrucchiolo

Anti-Slip Adhesive Tape/ Antidérapant/ Cinta Adhesiva Antideslizante

Antisdrucchiolo :

I Nastri Antiscivolo autoadesivi sono la risposta più efficace, semplice ed economica per sanare superfici sdruciolevoli eliminando il rischio di pericolose cadute per scivolamento. Un rischio che andrebbe valutato con attenzione sia in ambienti domestici, che industriali. Le superfici a rischio più frequenti in casa sono ad esempio le vasche da bagno o le docce. In casa o in esterni superfici potenzialmente pericolose sono le scale. I modelli si dividono per uso calzati o calzati.
Colori : nero, bianco, trasparente, segnaletico.

Vantaggi :

Utilizzabile in interni ed esterni su superfici lisce, non porose. Facile, veloce, pulito, economico.

Anti-slip adhesive tape :

Self-adhesive anti-slip tapes are the most effective, simple and economical answer to remedy slippery surfaces, eliminating the risk of dangerous falls due to slipping. A risk that should be carefully evaluated in both domestic and industrial environments. The most risky indoor surfaces are, for example, bathtubs or showers as well as stairs that are dangerous surfaces both for indoor and outdoor. Our range also includes item suitable for barefoot.
Colours: black, white, transparent, warning tape.

Advantages :

Can be used indoors and outdoors on smooth, non-porous surfaces. Easy, fast, clean, cheap.

Antidérapant :

Les rubans antidérapants auto-adhésifs sont la réponse la plus efficace, simple et économique pour remédier aux surfaces glissantes, éliminant le risque de chutes dangereuses dues au glissement. Un risque qui doit être soigneusement évalué dans les environnements domestiques et industriels. Les surfaces à risque les plus fréquentes dans la maison sont, par exemple, les baignoires ou les douches. À la maison ou à l'extérieur, les surfaces potentiellement dangereuses sont des escaliers. Les modèles sont divisés par utilisation pieds nus ou chaussés.
Couleurs: noir, blanc, transparent, signalisation

Les avantages :

Peut être utilisé à l'intérieur et à l'extérieur sur des surfaces lisses et non poreuses. Facile, rapide, propre, pas cher.























Cinta Adhesiva Antideslizante :

Las cintas antideslizantes autoadhesivas son la respuesta más eficaz, simple y económica para corregir superficies resbaladizas, eliminando el riesgo de caídas peligrosas debido al deslizamiento. Un riesgo que debe evaluarse cuidadosamente sea en entornos domésticos que industriales. Las superficies de riesgo más frecuentes en el hogar son, por ejemplo, bañeras o duchas. En el hogar o al aire libre, las superficies potencialmente peligrosas son las escaleras. Los modelos se dividen por uso descalzo o calzado.
Colores: negro, blanco, transparente, señalización.

Ventajas :

Se puede usar en interiores y exteriores en superficies lisas, no porosas. Fácil, rápido, limpio y económico.





Colore - Colour	Cod.	EAN	Utilizzo - Usage	Grit	(mm)	L. (m)	Min. ord.		
 20 nero black	 089S	8013237041854	Classico - Classic	60	20	5	10		
	 089	8013237000899	Classico - Classic	60	20	18	10		
 25 nero black	 089AS	8013237041878	Classico - Classic	60	25	5	10		
	 089A 	8013237008918	Classico - Classic	60	25	18	10		
 50 nero black	090	8013237000905	Classico - Classic	60	50	18	10		
 25 bianco white									
 20 nero black									
 25 nero black									
 25 bianco white	 094A	8013237143015	Non abrasivo - Non abrasive	-	25	5	10		
	 094	8013237143008	Non abrasivo - Non abrasive	-	25	18	10		
 25 trasparente transparent	 092A	8013237142995	Non abrasivo - Non abrasive	-	25	5	10		
	 092	8013237142988	Non abrasivo - Non abrasive	-	25	18	10		
 25 50 giallo/nero yellow/black									
									

Caratteristiche:
Specifications:



ANTISDRUCCILO ARCANSAS, CARATTERISTICHE FISICO-MECCANICHE
ARCANSAS ANTI-SLIP TAPE, PHYSICAL AND MECHANICAL CHARACTERISTICS

Supporto Tape material	Spessore Thickness	Superficie Antidrucciolo Non-Slip Surface	Forza di adesione Adhesion force	Allung. alla rottura Ultimate tensile strength	Temperatura d'esercizio Service temperature	Colore Colour
PVC PVC	0,75 mm 0,75 mm	Grani di Carborundum Grains of Carborundum	5,8 N/cm 5,8 N/cm	50% 50%	-5+50°C -5+50°C	
PEVA PEVA	0,8 mm 0,8 mm	PEVA corrugato corrugated PEVA	- -	30% 30%	-5+60°C -5+60°C	
PVC PVC	0,75 mm 0,75 mm	Grani di Carborundum Grains of Carborundum	10 N/cm 10 N/cm	50% 50%	-5+50°C -5+50°C	



Giunti di dilatazione

Expansion joints/ Joints de dilatation/ Juntas de expansión

Giunti di dilatazione:

I giunti di dilatazione sono profili specificamente progettati per intervenire in maniera mirata sulle flessioni e compressioni della pavimentazione dovute principalmente alla costante pressione degli agenti atmosferici e ad escursione termica - in caso di superfici esterne - o ai continui movimenti della stessa pavimentazione che possono generare il prematuro distacco del rivestimento - anche in superfici interne.

La versatilità del profilo ne permette un'applicazione su diverse tipologie di pavimento, anche aventi diversa natura e spessore.

Si consiglia l'uso di giunti di dilatazione almeno ogni 15 Mq di superficie piastrellata.

Expansion joints:

Expansion joints are profiles specifically designed to face the needs of thermal expansion and contraction in indoor and outdoor floors that can bring about detachment or damage to the coating.

Arcansas expansion joints are very versatile and can be used in different types of floors, even with different thickness and material.

The use of expansion joints is recommended at least every 15 square meters of tiled surface.

Joints de dilatation :

Les joints de dilatation sont des profils spécifiquement conçus pour intervenir de manière ciblée sur les flexions et compressions du revêtement de sol dues principalement à la pression constante de los agents atmosphériques et à l'excursion thermique (dans le cas de surfaces externes) ou aux mouvements continus de ce même revêtement de sol qui peuvent engendrer le détachement prématuré du revêtement, même sur les surfaces internes.

La polyvalence du profilé permet de l'appliquer à différent type de revêtements de sol, ayant également une nature et une épaisseur différentes.











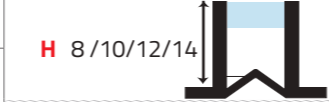

Nous recommandons l'utilisation de joints de dilatation au moins tous les 15 mètres carrés de surface carrelée.

Juntas de expansión:

Las juntas de expansión son perfiles diseñados específicamente para intervenir de manera específica en las flexiones y compresiones del suelo debido principalmente a la presión constante de los agentes atmosféricos y a la amplitud térmica - en el caso de superficies externas - o a los movimientos continuos de los mismos suelos que pueden generar despegue prematuro del revestimiento, incluso en superficies internas.

La versatilidad del perfil permite que se aplique a diferentes tipos de suelos, también con diferente naturaleza y grosor.

Recomendamos el uso de juntas de expansión al menos cada 15 metros cuadrados de superficie de baldosa.

CER	Finitura- Finish	Range di applicazione	H. (mm)	EAN	Cod.	Caratteristiche	L. (m)	Conf Carton	Min. ord.
	 fuga grigia grey joint	 H 8/10/12/14	8	8013237019570	259A 		2,00	50	10
			10	8013237019600	259B 		2,00	50	10
			12	8013237019631	259C 		2,00	50	10
			14	8013237019662	259D 		2,00	50	10
	 fuga trasparente clear joint		8	8013237019587	259A1 		2,00	50	10
			10	8013237019617	259B1 		2,00	50	10
			12	8013237019648	259C1 		2,00	50	10
			14	8013237019686	259D1		2,00	50	10

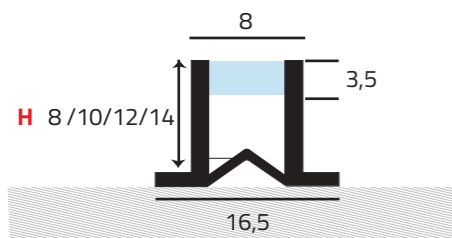



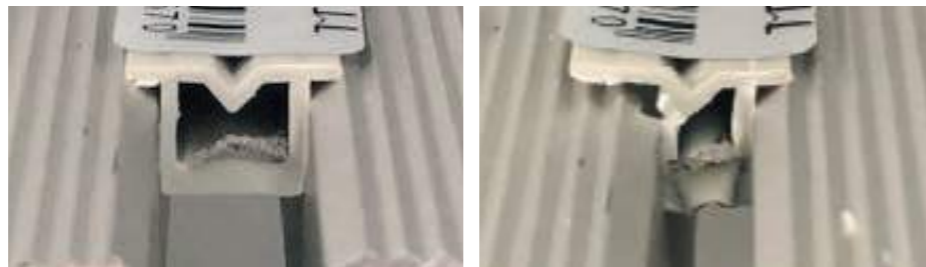

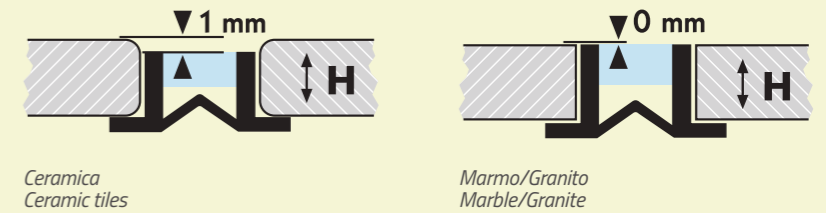

Giunto sottoposto a compressione/ Expansion joint in contraction

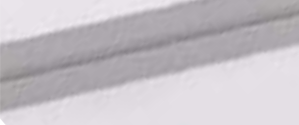

Metodo di posa/Installation method



ELASTOCER/ S ALETTE

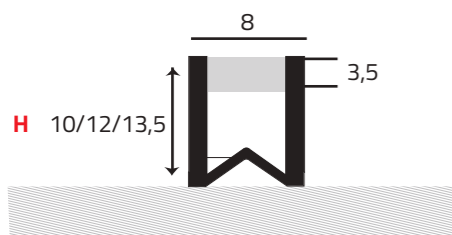

ELASTOCER/ S ALETTE	Finitura- Finish	Range di applicazione	H. (mm)	EAN	Cod.	Caratteristiche	L. (m)	Conf Carton	Min. ord.
	 fuga grigia grey joint	 H 10/12/13,5	8	8013237142018	259F 		2,00	50	10
			10	8013237071578	259E 		2,00	50	10
			12	8013237071585	259G 		2,00	50	10
			13,5	8013237133436	259L 		2,00	50	10

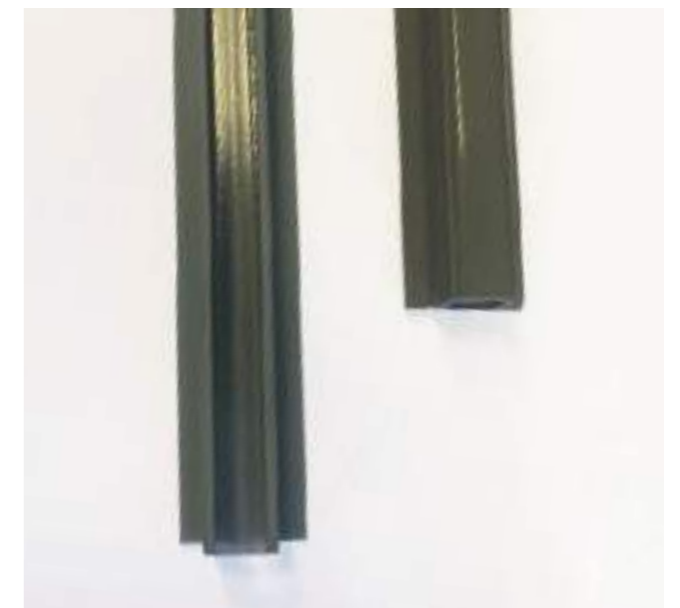
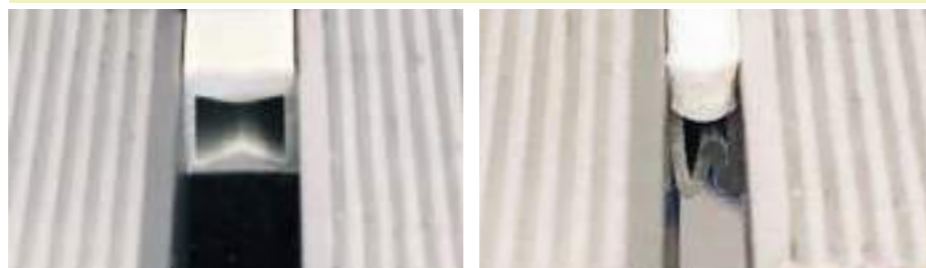

Giunto sottoposto a compressione/ Expansion joint in contraction

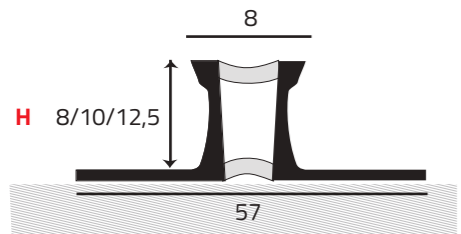

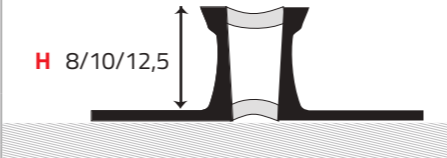

Finitura- Finish	Range di applicazione	H. (mm)	EAN	Cod.	Caratteristiche	L. (m)	Conf Carton	Min. ord.		
 fuga grigia grey joint	 H 8/10/12,5	8	8013237020484	380C (FR)		2,50	50	10		
		10	8013237003807	380D (FR)		2,50	50	10		
		12,5	8013237020545	380E (FR)		2,50	50	10		

Metodo di posa/Installation method/

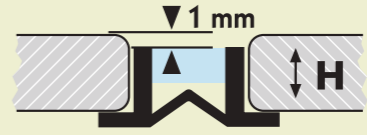

▼ 1 mm

Ceramica
Ceramic tiles

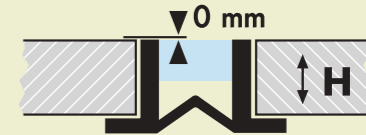

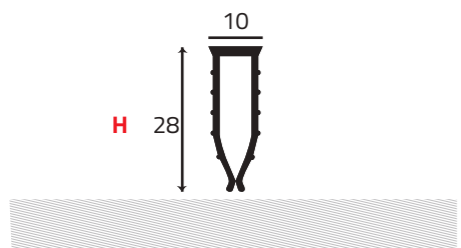

▼ 0 mm

Marmo/Granito
Marble/Granite

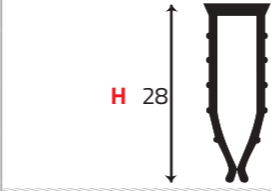

Finitura- Finish	Range di applicazione	H. (mm)	EAN	Cod.	Caratteristiche	L. (m)	Conf Carton	Min. ord.				
 grigio satinato satin grey	 H 28											

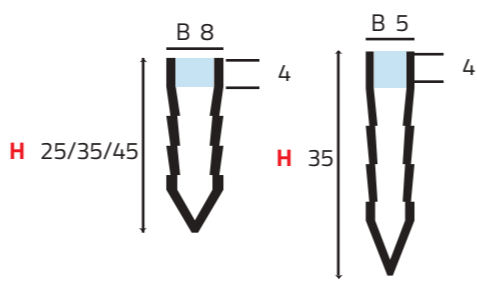

Finitura- Finish	Range di applicazione	H. (mm)	EAN	Cod.	Caratteristiche	L. (m)	Conf. Carton	Min. ord.		
 fuga grigia grey joint		25	8013237019716	260A (FR)		2,50	50	10		
		35	8013237019785	260E (FR)		2,50	50	10		
35		8013237148522	260D3 (FR)	2,50		50	10			
 fuga trasparente clear joint										

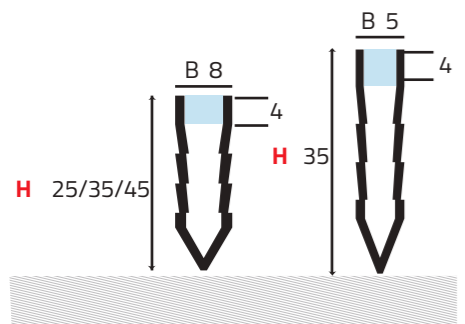

Finitura- Finish	Range di applicazione	BxH. (mm)	EAN	Cod.	Caratteristiche	L. (m)	Conf. Carton	Min. ord.		
 fuga grigia grey joint										
 fuga trasparente clear joint										
 grigio satinato satin grey										

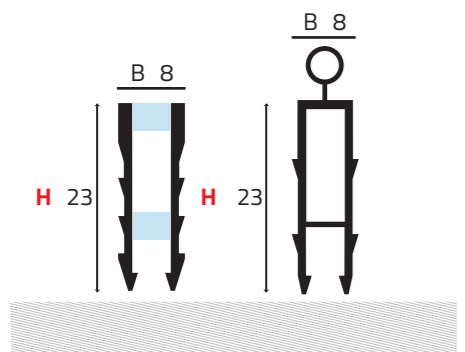



Perfect Matching

ARCANSAS ha progettato un sistema completo di profili per ambienti in parquet e laminati.

Tutte le finiture legno sono disponibili sia per batilam, che per le varie forme di profili parquet.

Catalogo Suolo/ Flooring catalogue

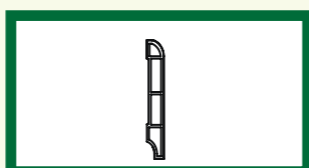
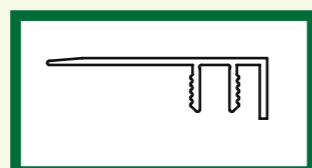
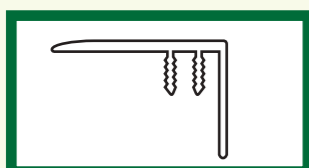
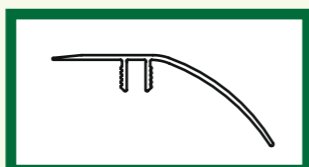
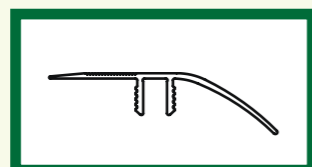
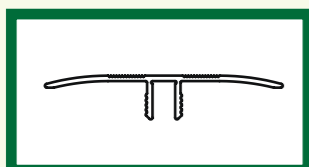
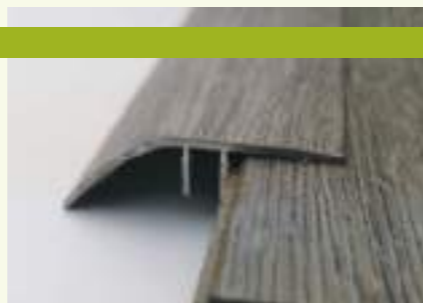

Speciale laminati e parquet

Laminates and Parquet/ Stratifiés et parquet/ Laminadas y Parquet

Sono progettati espressamente per risolvere i grandi problemi di dilatazione e rifinitura di tutti i pavimenti di parquet laminato. L'effetto legno è ottenuto mediante ricopertura a caldo del profilo di alluminio con speciale pellicola in Pvc che riproduce fotograficamente la superficie del parquet. Straordinario realismo, resistenza a i graffi, all'usura, ai detersivi, all'acqua, al colore, sono le sue insostituibili peculiarità.

Finiture disponibili: Alluminio

Vantaggi:

- Altamente decorativi
- Resistenti ai graffi
- Soluzione per problemi di dilatazione
- Facilità di applicazione
- Scarsa manutenzione
- Perfettamente abbinabili con profili dotati di pellicola color legno

Special range for laminate flooring. They are specifically designed to solve the tough issues in the expansion and finishing of all laminate parquet flooring. The wooden effect is obtained by the hot-covering of the aluminium profile with a specific PVC film, which replicates photographically the surface of the parquet flooring. The irreplaceable peculiarity of these products is not only the extraordinary realism, but also the resistance to scratches and usury, to any kind of soap, to water and colours. Available finishings: Aluminium

Strong points:

- Highly decorative
- Resistant to scratches
- Ideal to solve flooring expansion issues
- Easy to applicate
- Little maintenance is required
- Match perfectly with any other kind of wooden effect film-coated profiles from Arcansas range

Spécifiques pour les stratifiés et parquets : ils sont expressément conçus pour résoudre les grands problèmes de dilatation et de finition de tous les parquets stratifiés. L'effet bois est obtenu en recouvrant à chaud le profilé en aluminium d'un film PVC spécial qui reproduit photographiquement la surface du parquet. Un réalisme extraordinaire, une résistance aux rayures, à l'usure, aux détergents, à l'eau, à la couleur, sont ses particularités irremplaçables.

Finitions disponibles : aluminium

Avantages:

- Très décoratif
- Résistant aux rayures
- Solution pour les problèmes de dilatation
- Facilité d'application
- Faible entretien
- Parfaitement combinable avec des profilés avec un film de couleur bois

Laminados especiales y parquet: Están expresamente diseñados para solucionar los grandes problemas de dilatación y acabado de todos los suelos de parquet laminados. El efecto madera se obtiene cubriendo el perfil con una película especial de PVC bajo calor que reproduce fotográficamente la superficie del parquet. Realismo extraordinario, resistencia a los arañazos, al desgaste, a los detergentes, al agua, al color, son sus peculiaridades insustituibles.

Acabados disponibles: Aluminio

Ventajas:

- Muy decorativo
- Resistente al rayado
- Solución para problemas de dilatación
- Facilidad de aplicación
- Se necesita de poco mantenimiento
- Perfectamente combinable con perfiles con película color madera

KIT PIATTOPARC	Finitura- Finish	Range di applicazione	B.(mm)	EAN	Cod.	Caratteristiche	L. (m)	Conf.Carton	Min. ord.
	anodizzato satinato liscio argento smooth satin anodised silver		42	8013237054861	025GA2/90		0,90	30	5
	rovere rovere								
	faggio chiaro pale beech		42	8013237063115	027G6/123		0,90	30	5
	faggio beech								
	noce scuro dark walnut		42	8013237063115	027G6/123		0,90	30	5
	ciliegio cherry								
	wengè wengè								

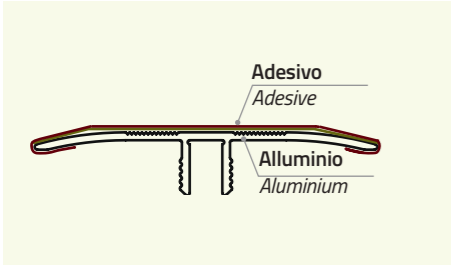

* KIT PIATTOPARC B. 40mm
forniti di base 6/10mm

* PIATTOPARC KIT Profiles supplied with 6/10mm base

Baseparc

APPLICAZIONE PROFILO ALLA BASE

Application of the profile to the base

Applicazione del profilo con viti (non incluse)

Application of the profile with screws (not included)

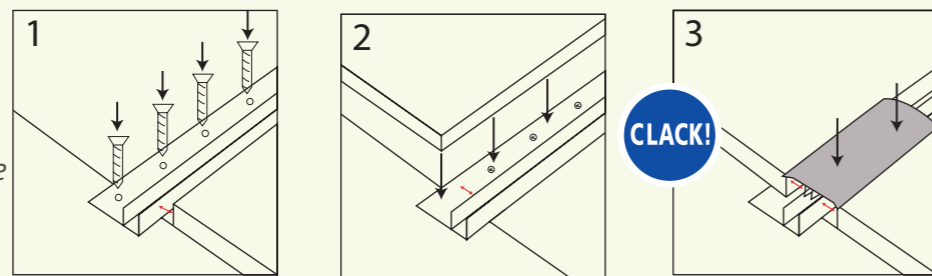

DILATAZIONE TERMICA/ Thermal expansion

Si consiglia l'applicazione del pavimento ad una distanza di 5mm dalla base, in ambedue i lati
 The flooring should be applied with a 5-mm-distance from the base in both sides
 L'application du sol est recommandée à une distance de 5 mm de la base, des deux côtés
 Se recomienda aplicar el suelo a una distancia de 5mm de la base, por ambos lados

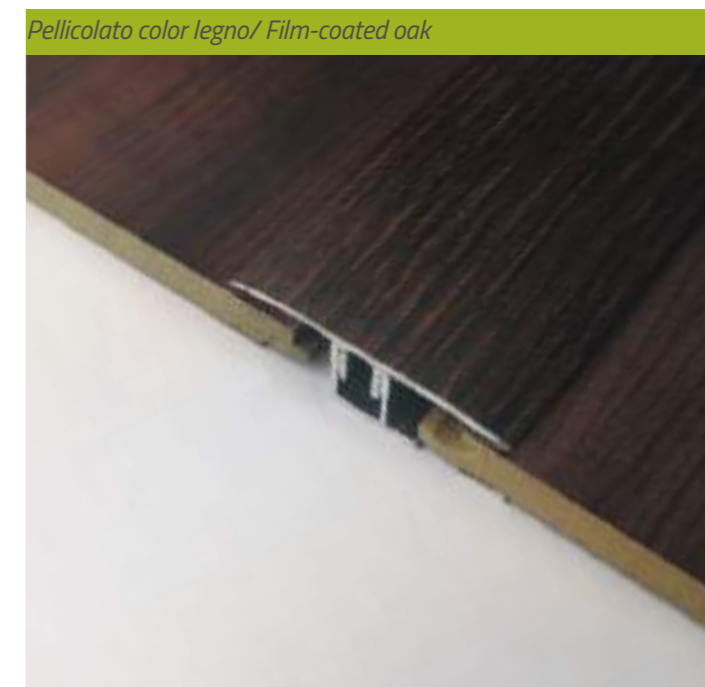
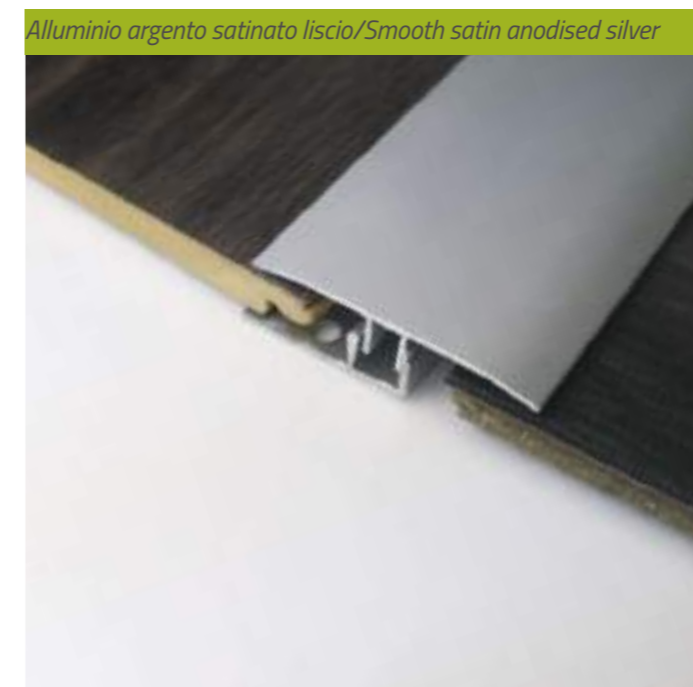
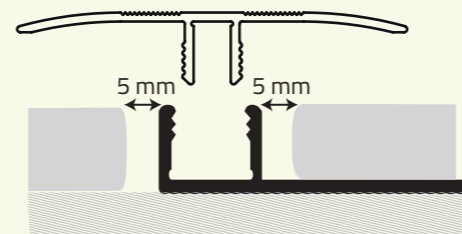

PIATTOPARC		B.(mm)	EAN	Cod.	Caratteristiche	L. (m)	Conf.Carton	Min. ord.			
	anodizzato satinato liscio argento smooth satin anodised silver	42	8013237042707	025GA/90		2,70	30	5			
	anodizzato satinato zigrinato argento knurled satin anodised	42	8013237054366	025GA1/90			0,90	30	5		
	anodizzato satinato zigrinato oro	42	8013237048587	027X/90		2,70	30	5			
	anodizzato satinato zigrinato bronzo	42	8013237056421	025G3/90		1,80	30	5			
	anodizzato satinato zigrinato bronzo	42	8013237053826	027X1/90			0,90	30	5		
	anodizzato satinato zigrinato bronzo										
	rovere moke moke oak										
	rovere rovere	42	8013237043308	027/121			2,70	30	5		
	rovere rovere	42	8013237061791	028/121			0,90	30	5		
	rovere rovere	42	8013237043322	027/123			2,70	30	5		
faggio beech											
faggio beech	42	8013237053857	028/123			0,90	30	5			
noce biondo blond walnut											
noce chiaro light walnut											

Scegli la tua base

Choose your Base
 * Baseparc pag. 180
 Profilo con base non inclusa
 Profile with base not included
 Valutare l'altezza della base, se si ha tappetino da 2/3 mm
 Evaluate the height of the base, if you have a 2/3 mm mat

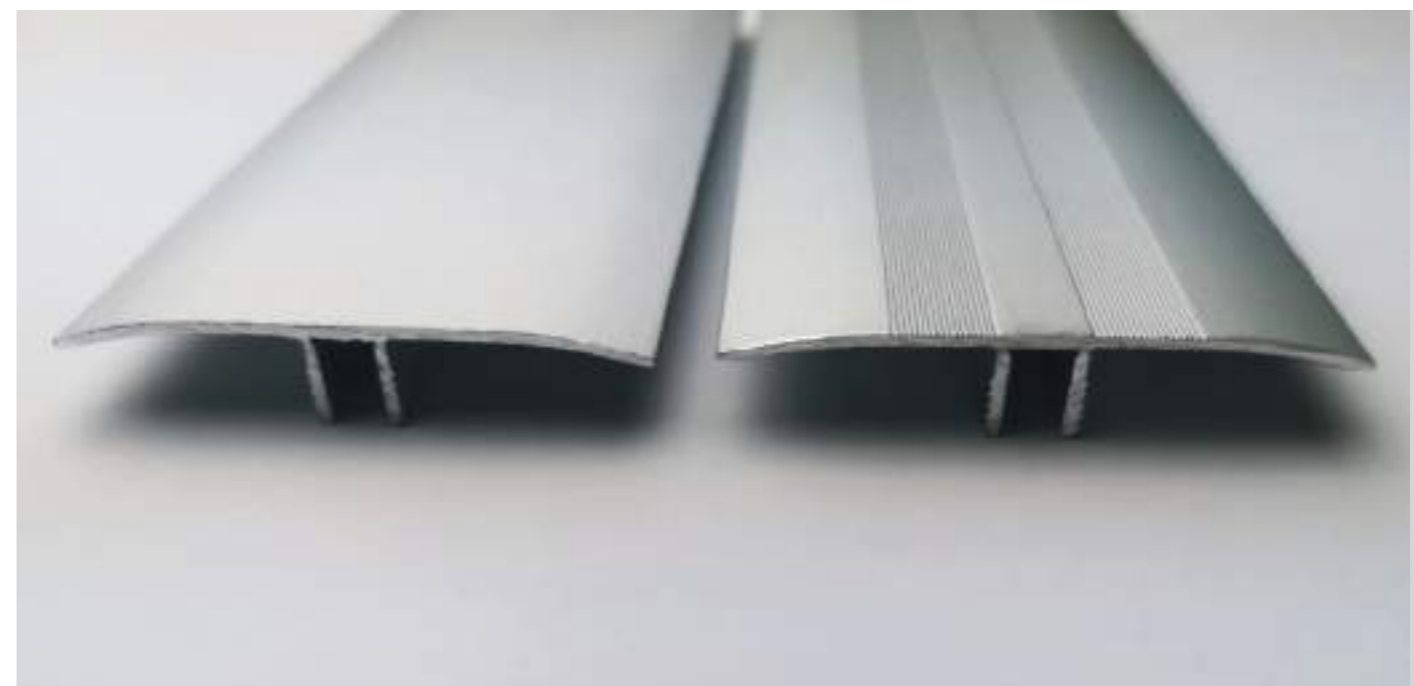
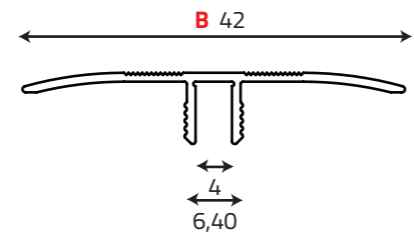

PIATTOPARC



Scegli la tua base

Choose your Base

* Baseparc pag. 180

Profilo con base non inclusa

Profile with base not included

Valutare l'altezza della base, se si ha tappetino da 2/3 mm

Evaluate the height of the base, if you have a 2/3 mm mat

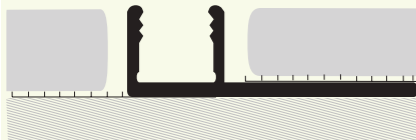

Finitura- Finish	
	ciliegio cherry
	faggio silver silver beech
	rovere sbiancato bleached oak
	noce walnut
	wengè wengè
	merbau merbau
	acero bianco pale maple
	doussiè doussiè
	noce rosso red walnut
	acero bianco Swhite maple
	grigio rovere Solbiato Solbiato oak grey

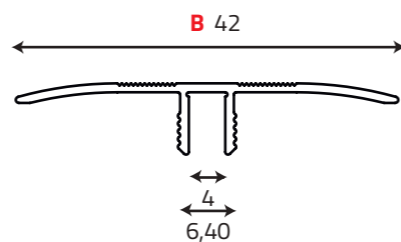

B.(mm)	EAN	Cod.	Caratteristiche	L. (m)	Conf. Carton	Min. ord.
42	8013237047634	027/129		2,70	30	5
30	8013237138233	027/143		2,70	30	5

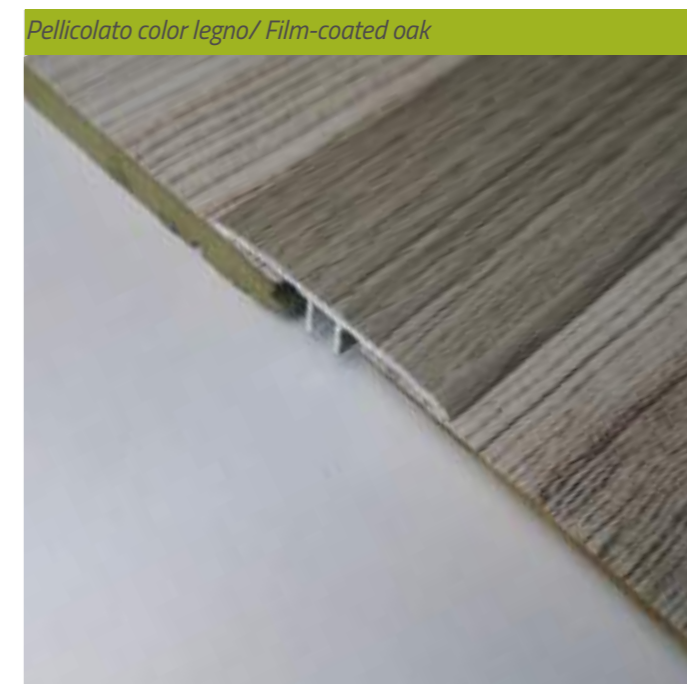
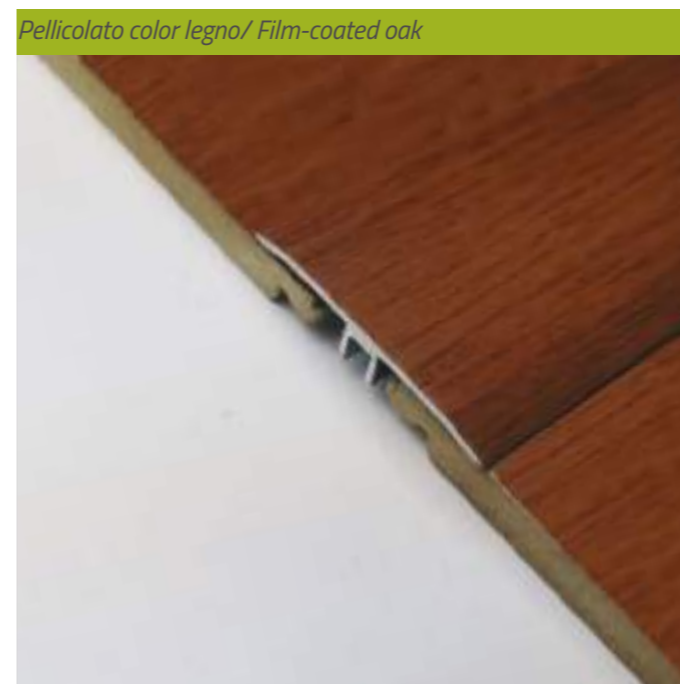
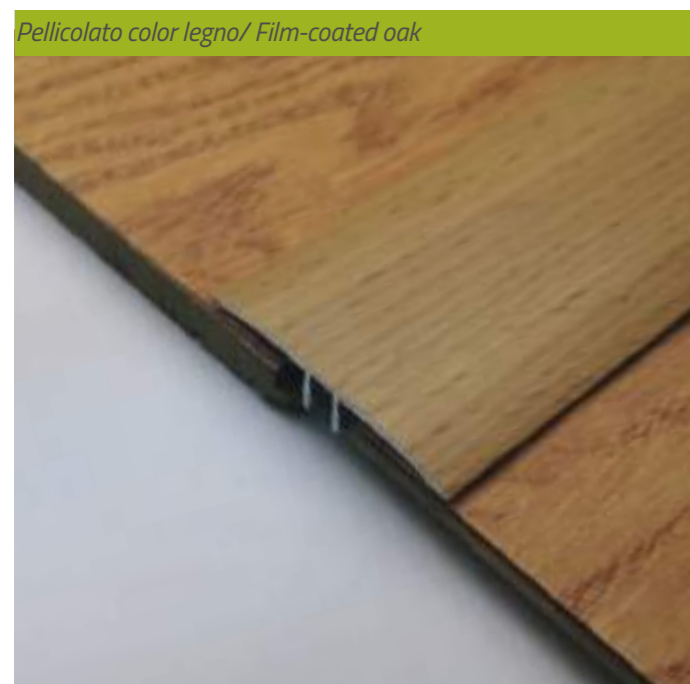

PIATTOPARC		Finitura- Finish	B. (mm)	EAN	Cod.	Caratteristiche	L. (m)	Conf. Carton	Ord.min.
	New	grigio DB2 DB2 grey	42	8013237138240	027/144		2,70	30	5
	New	faggio sbiancato bleached beech	42	8013237146085	027/145		2,70	30	5
	New	rovere chiaro light oak	42	8013237146092	027/146		2,70	30	5
	New	rovere scuro dark oak	42	8013237146252	027G6/146		0,90	30	5
	New	noce naturale natural walnut							
	New	faggio naturale natural beech	42	8013237146122	027/149		2,70	30	5
	New	bamboo sbiancato bleached bamboo	42	8013237146283	027G6/149		0,90	30	5
	New	bamboo sbiancato bleached bamboo	42	8013237146139	027/150		2,70	30	5
	New	magellan ice magellan ice	42	8013237146146	027/152		2,70	30	5
	New	magellan ice magellan ice	42	8013237146306	027G6/152		0,90	30	5
	New	rovere KY KY oak	42	8013237146153	027/153		2,70	30	5
	New	rovere KY KY oak	42	8013237146313	027G6/153		0,90	30	5
	New	acero grigio grey maple	42	8013237146597	027/154		2,70	30	5
	New	acero grigio grey maple	42	8013237149109	027G6/154		0,90	30	5
New	wodec cement wodec cement	42	8013237146603	027/155		2,70	30	5	
New	wodec cement wodec cement	42	8013237149116	027G6/155		0,90	30	5	
New	wodec turner wodec turner	42	8013237146627	027/157		2,70	30	5	
New	wodec turner wodec turner	42	8013237149123	027G6/157		0,90	30	5	

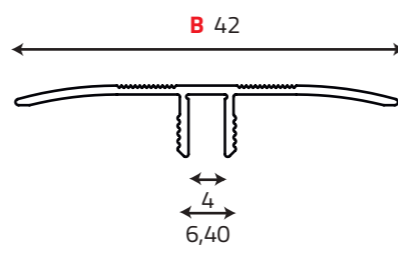

Scegli la tua base

Choose your Base

* Baseparc pag. 180

Profilo con base non inclusa

Profile with base not included

Valutare l'altezza della base, se si ha tappetino da 2/3 mm

Evaluate the height of the base, if you have a 2/3 mm mat

Evaluate the height of the base, if you have a 2/3 mm mat

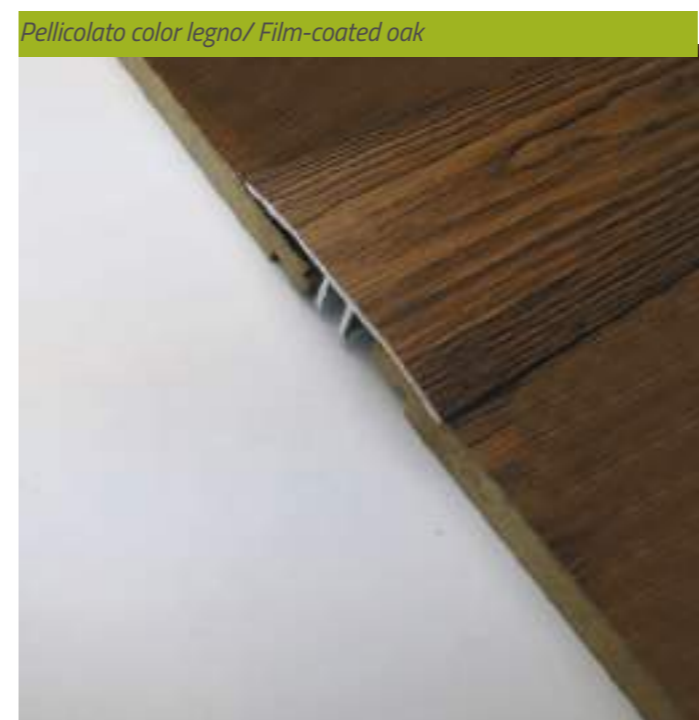
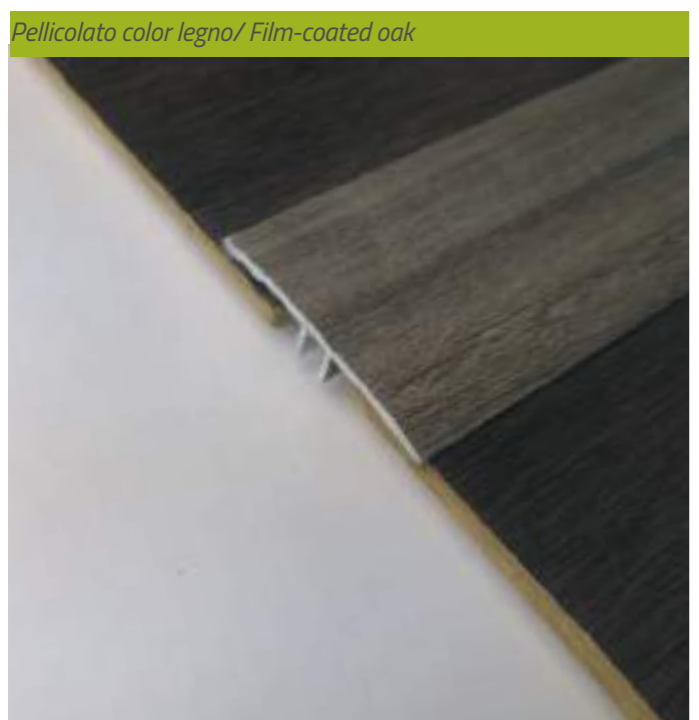
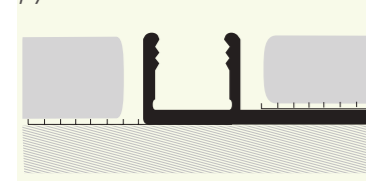



KIT SCIVOPARC











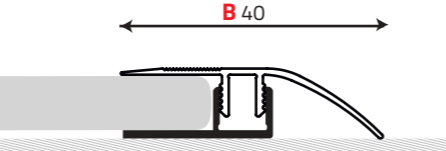



*** KIT SCIVOPARC B. 40mm
forniti di base 6/10mm**

** SCIVOPARC KIT Profiles supplied
with 6/10mm base*

*** KIT SCIVOPARC B. 52mm
forniti di base 10/16mm**

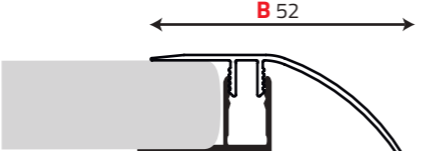
** SCIVOPARC KIT Profiles supplied with
6/10mm base*

Finitura- Finish		B.(mm)	EAN	Cod.	Caratteristiche	L (m)	Conf. Carton.	Ord.min.	
	anodizzato satinato liscio argento smooth satin anodised silver		40	8013237054823	025HA2/90 	 	0,90	30	5
	anodizzato satinato zigrinato argento knurled satin anodised		40	8013237061814	028A/121	 	0,90	30	5
	rovere superior superior rovere		40	8013237053895	028A/123	 	0,90	30	5
	faggio beech								
	faggio silver silver beech								
	wengè wengè								

Baseparc

**APPLICAZIONE PROFILO
ALLA BASE**

Application of the profile to the base

**Applicazione del profilo con viti
(non incluse)**

Application of the profile with screws (not included)

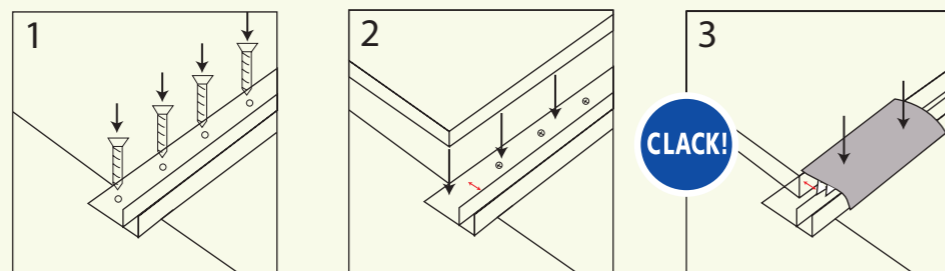

**DILATAZIONE TERMICA/
Thermal expansion**

Si consiglia l'applicazione del pavimento ad una distanza di 5mm dalla base, in ambedue i lati
The flooring should be applied with a 5-mm-distance from the base in both sides
L'application du sol est recommandée à une distance de 5 mm de la base, des deux côtés
Se recomienda aplicar el suelo a una distancia de 5mm de la base, por ambos lados

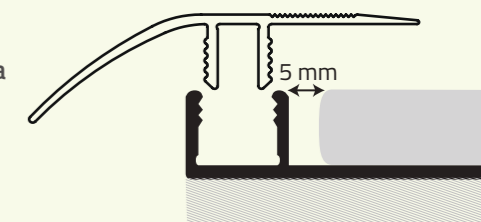



Scegli la tua base

Choose your Base

* Baseparc pag. 180

Profilo con base non inclusa

Profile with base not included

Valutare l'altezza della base, se si ha tappetino da 2/3 mm

The height of the base should be taken in count in case of 2/3 mm mat

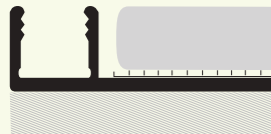

Finitura- Finish			B.(mm)	EAN	Cod.	Caratteristiche	L (m)	Conf. Carton.	Ord.min.			
	anodizzato satinato liscio argento		40	8013237047221	025HA/90		2,70	30	5			
	smooth satin anodised silver		40	8013237054335	025HA1/90			0,90	30	5		
	anodizzato satinato zigrinato argento		52	8013237047238	025LA/90			2,70	30	5		
	knurled satin anodised		52	8013237054359	025LA1/90			0,90	30	5		
	anodizzato satinato zigrinato oro		40	8013237048617	027AX/90			2,70	30	5		
	knurled satin anodised gold		40	8013237056438	025H3/90			1,80	30	5		
	rovere moke		40	8013237053871	027AX1/90			0,90	30	5		
	moke oak		52	8013237056384	025L1/90			2,70	30	5		
	rovere superior		52	8013237054342	027BX1/90			0,90	30	5		
	superior rovere		40	8013237043360	027A/121			2,70	30	5		
	faggio chiaro											
	film-coated pale beech											
	faggio											
	film-coated beech		40	8013237043384	027A/123			2,70	30	5		
					40	8013237063191	027A6/123	0,90	30	5		

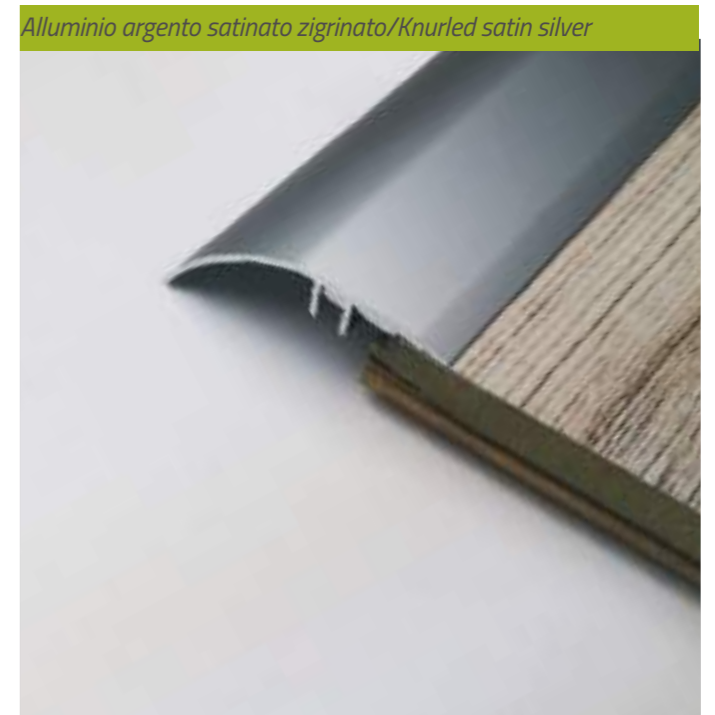
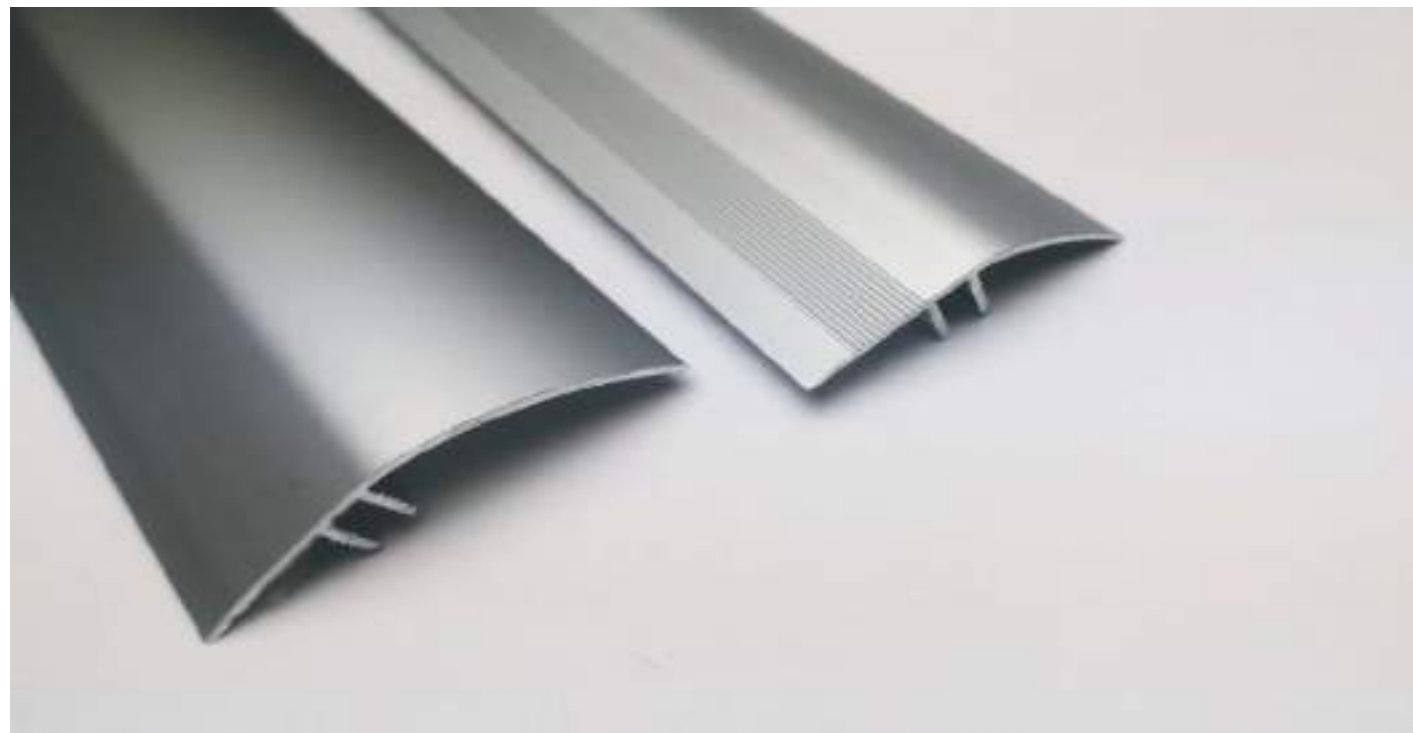



Scegli la tua base

Choose your Base

* Baseparc pag. 180

Profilo con base non inclusa

Profile with base not included

Valutare l'altezza della base, se si ha tappetino da 2/3 mm

The height of the base should be taken in count in case of 2/3 mm mat

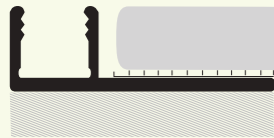

Finitura- Finish			B.(mm)	EAN	Cod.	Caratteristiche	L (m)	Conf. Carton.	Ord.min.
	noce biondo blond walnut								
	noce scuro dark walnut								
	noce chiaro light walnut								
	ciliegio cherry								
	faggio silver silver beech								

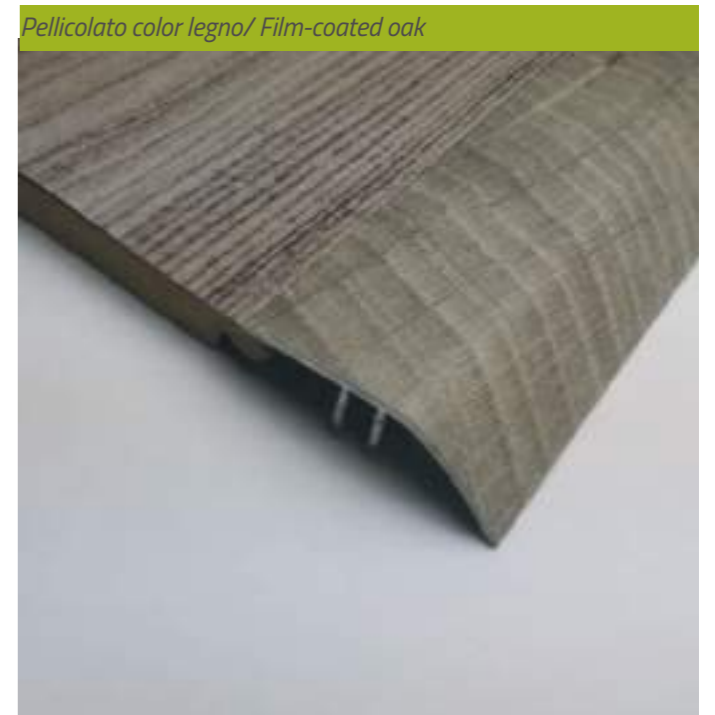
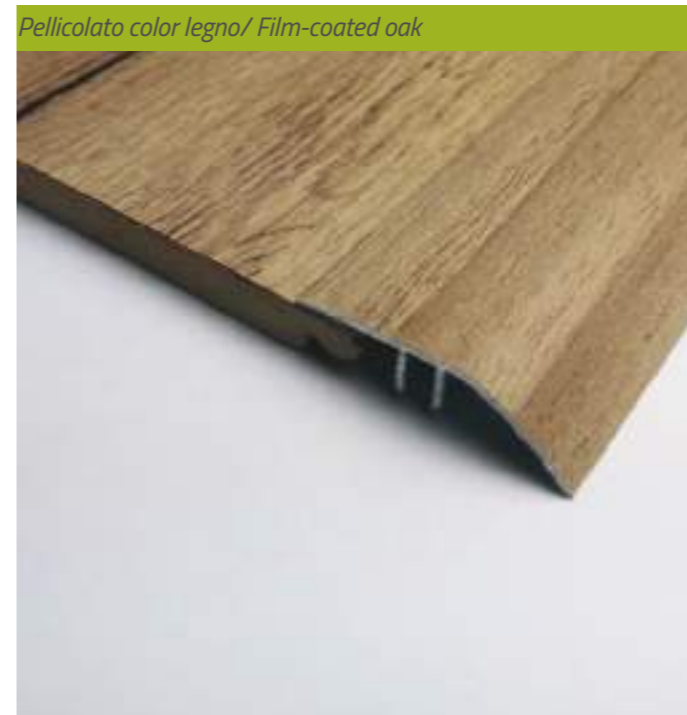
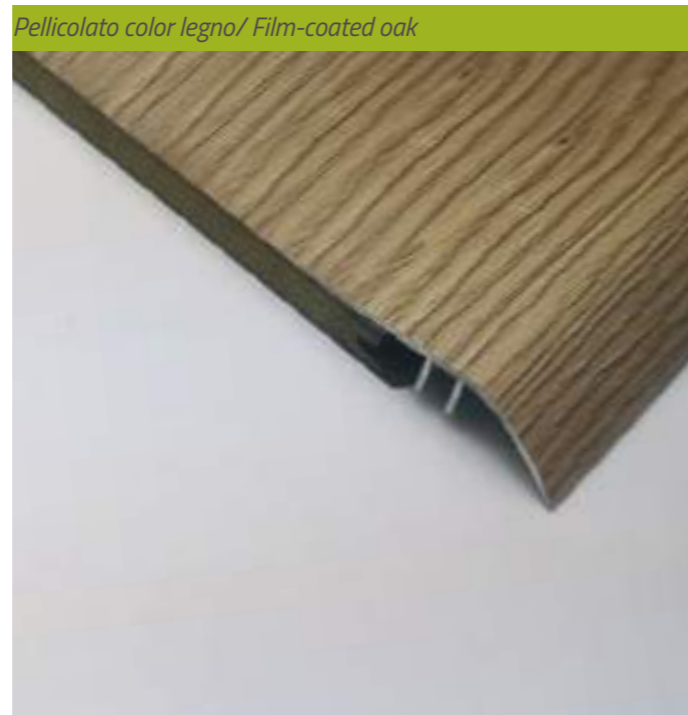

SCIVOPARC	Finitura- Finish		B.(mm)	EAN	Cod.	Caratteristiche	L (m)	Conf. Carton.	Ord.min			
	rovere sbiancato bleached oak		40	8013237047733	027A/129		2,70	30	5			
	noce walnut											
	wengè wengè											
	merbau merbau											
	acero bianco pale maple											
	doussiè doussiè											
	noce rosso red walnut											
	acero bianco Swhite maple			40	8013237049270	027A/139		2,70	30	5		
	grigio rovere Solbiate Solbiate oak grey			40	8013237138257	027A/143		2,70	30	5		

Scegli la tua base

Choose your Base

* Baseparc pag. 180

Profilo con base non inclusa

Profile with base not included

Valutare l'altezza della base, se si ha tappetino da 2/3 mm

The height of the base should be taken in count in case of 2/3 mm mat

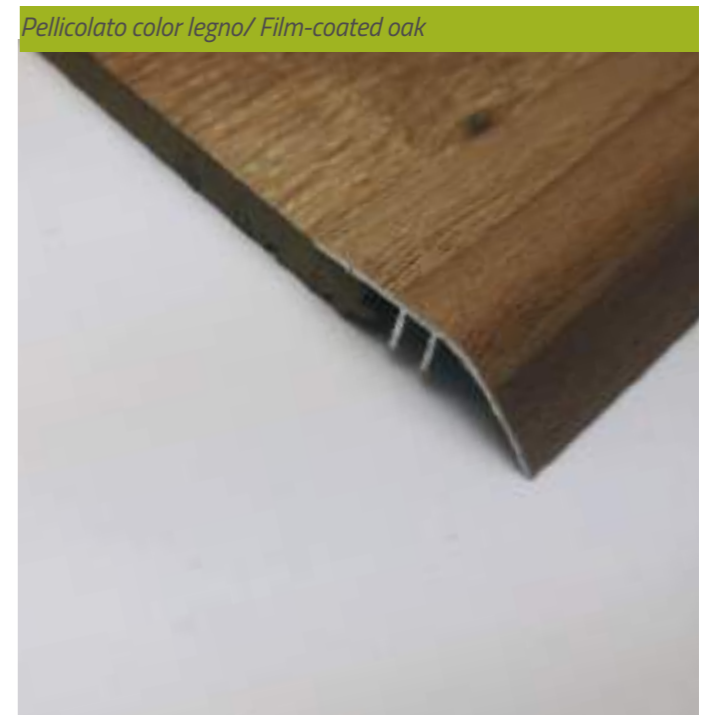
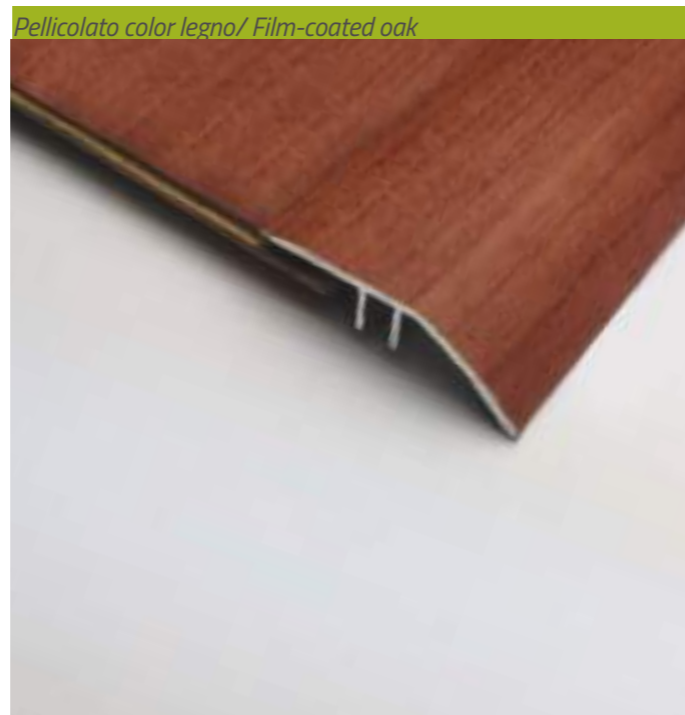
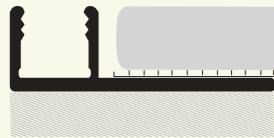



Scegli la tua base

Choose your Base

* Baseparc pag. 180

Profilo con base non inclusa

Profile with base not included





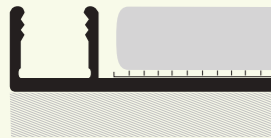



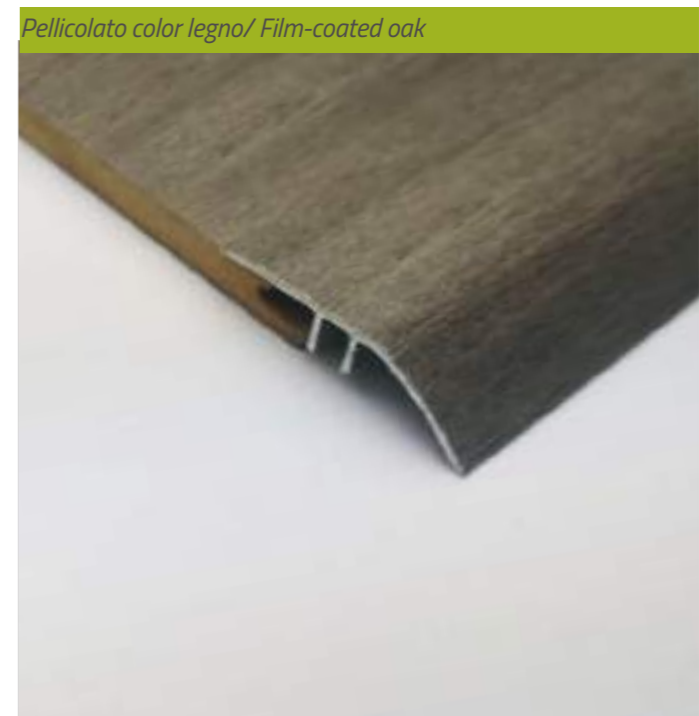
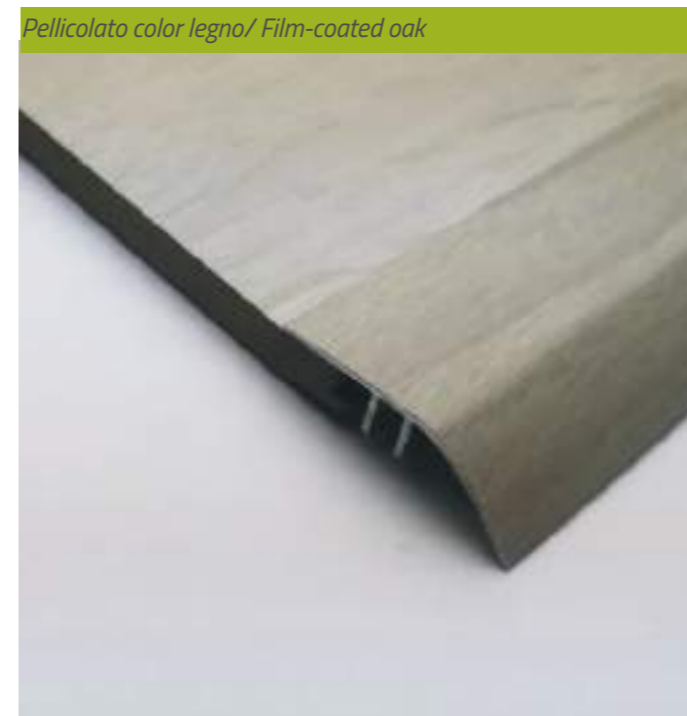
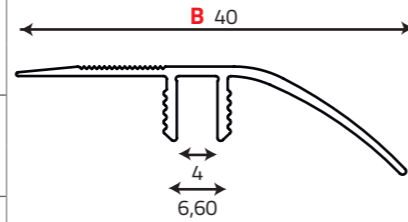



Valutare l'altezza della base, se si ha tappetino da 2/3 mm

The height of the base should be taken in count in case of 2/3 mm mat



Finitura- Finish		B.(mm)	EAN	Cod.	Caratteristiche	L (m)	Conf. Carton.	Ord.min
New	grigio DB2 DB2 grey	40	8013237138264	027A/144		2,70	30	5
		40	8013237146405	027A6/144			0,90	30
New	faggio sbiancato bleached beech							
	rovere chiaro light oak	40	8013237146177	027A/146		2,70	30	5
	rovere scuro dark oak	40	8013237146337	027A6/146			0,90	30
New	noce naturale natural walnut							
	faggio naturale natural beech	40	8013237146207	027A/149			2,70	30
New	bamboo sbiancato bleached bamboo							
	magellan ice magellan ice	40	8013237146221	027A/152			0,90	30
New	rovere KY KY oak	40	8013237146238	027A/153		2,70	30	5
	acero grigio grey maple	40	8013237146399	027A6/153			0,90	30
New	wodec cement wodec cement	40	8013237146689	027A/154		2,70	30	5
	wodec cement wodec cement	40	8013237149130	027A6/154			0,90	30
New	wodec turner wodec turner	40	8013237146696	027A/155		2,70	30	5
	wodec turner wodec turner	40	8013237149147	027A6/155			0,90	30
New	wodec turner wodec turner	40	8013237146719	027A/157		2,70	30	5
	wodec turner wodec turner	40	8013237149154	027A6/157			0,90	30

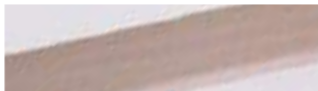

KIT TERMPARC		Finitura- Finish	B.(mm)	EAN	Cod.	Caratteristiche	L (m)	Conf. Carton.	Ord.min
 <p>* KIT TERMPARC B. 30mm forniti di base 6/10mm</p> <p><i>* TERMPARC KIT Profiles supplied with 6/10mm base</i></p>	 <p>anodizzato satinato zigrinato argento knurled satin anodised</p>	30	8013237054809	027CX2/90	     	0,90	30	5	
	 <p>rovere superior superior rovere</p>	30	8013237078447	027CB/121		0,90	30	5	
	 <p>faggio beech</p>								
	 <p>ciliegio film-coated cherry</p>								
	 <p>rovere sbiancato bleached oak</p>	30	8013237131876	027CB/129		0,90	30	5	
	 <p>noce walnut</p>								

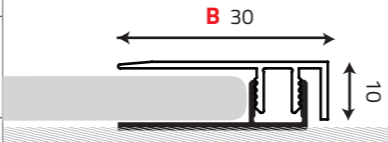

Baseparc

APPLICAZIONE PROFILO ALLA BASE

Application of the profile to the base

Applicazione del profilo con viti (non incluse)

Application of the profile with screws (not included)

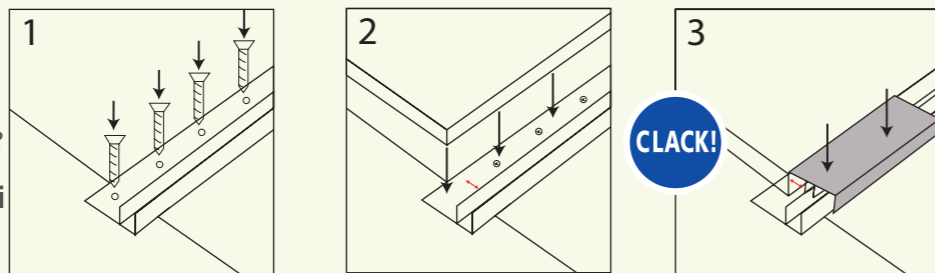

DILATAZIONE TERMICA/ Thermal expansion

Si consiglia l'applicazione del pavimento ad una distanza di 5mm dalla base, in ambedue i lati

The flooring should be applied with a 5-mm-distance from the base in both sides

L'application du sol est recommandée à une distance de 5 mm de la base, des deux côtés

Se recomienda aplicar el suelo a una distancia de 5mm de la base, por ambos lados

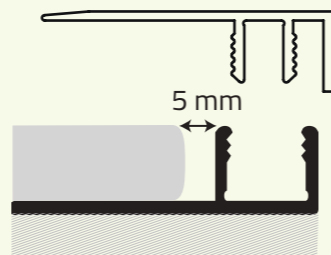



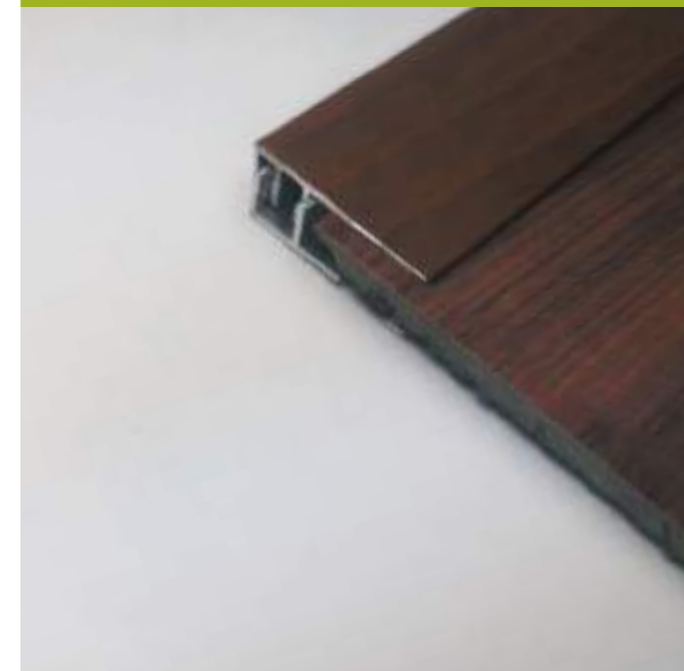





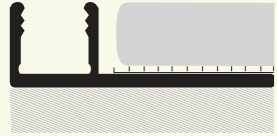













Pellicolato color legno/ Film-coated oak





Pellicolato color legno/ Film-coated oak

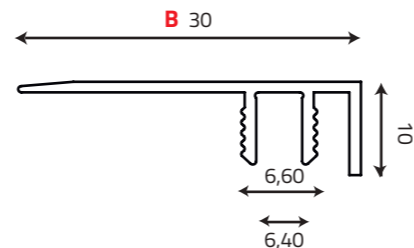

TERMPARC	Finitura- Finish	B.(mm)	EAN	Cod.	Caratteristiche	L (m)	Conf. Carton.	Ord.min	
 <p>Scegli la tua base Choose your Base</p> <p>* Baseparc pag. 180</p> <p>Profilo con base non inclusa Profile with base not included</p> <p>Valutare l'altezza della base, se si ha tappetino da 2/3 mm The height of the base should be taken in count in case of 2/3 mm mat</p> 	 <p>anodizzato satinato zigrinato argento knurled satin anodised</p>	30	8013237048679	027CX/90 		2,70	30	5	
			30	8013237056391	027C1/90		1,80	30	5
			30	8013237054328	027CX1/90 	 	0,90	30	5
		 <p>anodizzato satinato zigrinato oro knurled satin anodised gold</p>							
		 <p>bronzo bronze</p>							
		 <p>rovere moke moke oak</p>							
		 <p>rovere superior superior rovere</p>							
		 <p>faggio chiaro pale beech</p>							
		 <p>faggio beech</p>							
		 <p>noce scuro dark walnut</p>							
		 <p>noce biondo blond walnut</p>							
		 <p>noce chiaro light walnut</p>							
		 <p>ciliegio cherry</p>							
		 <p>faggio silver silver beech</p>							
		 <p>rovere sbiancato bleached oak</p>	30	8013237048051	027C/129		2,70	30	5
	 <p>noce walnut</p>								

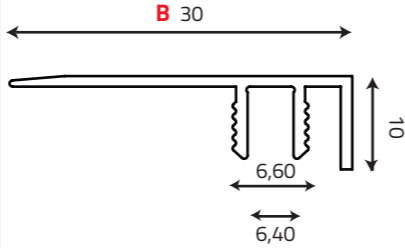

TERMPARC	Finitura- Finish	(mm)	EAN	Cod.	Caratteristiche	L (m)	Conf. Carton.	Ord.min	
	noce rosso red walnut		30	8013237138271	027C/143		2,70	30	5
	acero bianco Swhite maple								
	grigio rovere Solbiate Solbiate oak grey								
	wengè wengè								
	merbau merbau								
	acero bianco pale maple								
	doussiè doussiè								

Scegli la tua base

Choose your Base

* Baseparc pag. 180

Profilo con base non inclusa

Profile with base not included

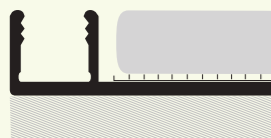

Valutare l'altezza della base, se si ha tappetino da 2/3 mm

The height of the base should be taken in count in case of 2/3 mm mat

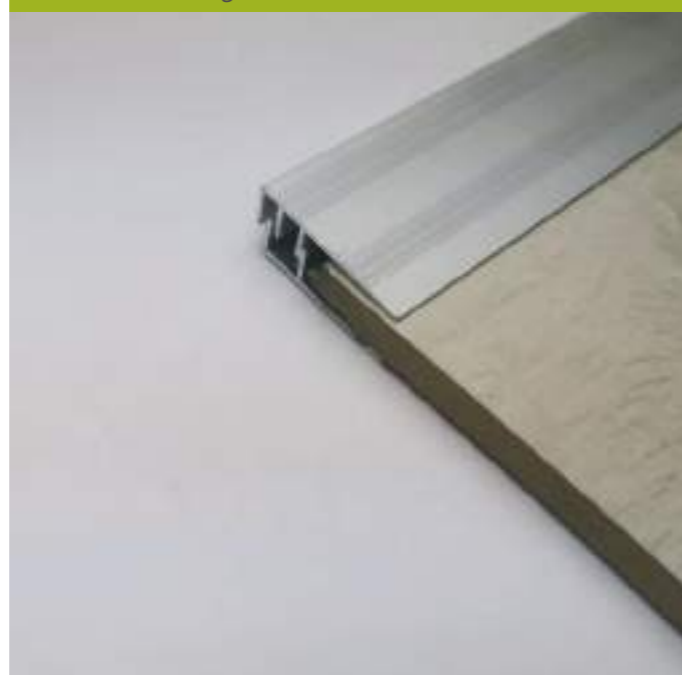

Alluminio satinato argento /Aluminium anodised silver

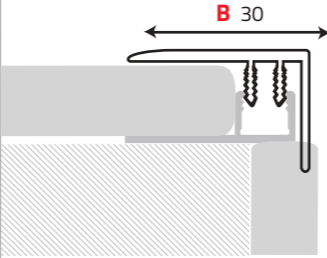

PARAPARC	Finitura- Finish		B.(mm)	EAN	Cod.	Caratteristiche	L (m)	Conf. Carton.	Ord.min								
	anodizzato satinato liscio argento smooth satin anodised silver		30	8013237054373	027DX1/90		0,90	30	5								
	anodizzato satinato zigrinato argento knurled satin anodised anodizzato satinato zigrinato oro knurles satin anodised gold																
	anodizzato satinato zigrinato bronzo knurles satin anodised bronze																
	rovere moke moke oak																
	rovere superior superior rovere																
	faggio chiaro pale beech																
	faggio beech																
	noce scuro dark walnut																

Scegli la tua base

Choose your Base

* Baseparc pag. 180

Profilo con base non inclusa
Profile with base not included

Valutare l'altezza della base,
se si ha tappetino da 2/3 mm

The height of the base should be taken
in count in case of 2/3 mm mat

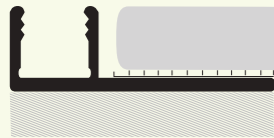

Baseparc

APPLICAZIONE PROFILO ALLA BASE

Application of the profile to the base

Applicazione del profilo con viti (non incluse)

Application of the profile with screws (not included)

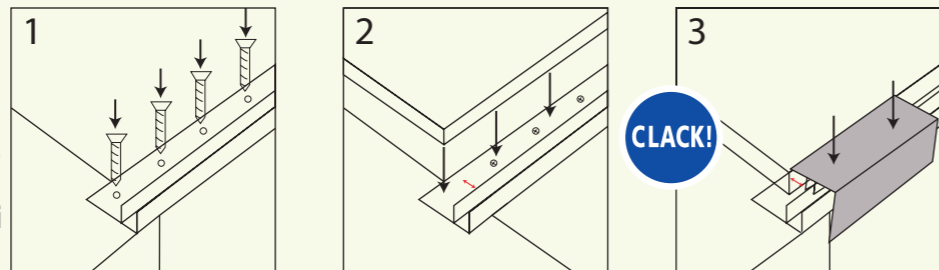

DILATAZIONE TERMICA/ Thermal expansion

Si consiglia l'applicazione del pavimento ad una distanza di 5mm dalla base, in ambedue i lati

The flooring should be applicated with a 5-mm-distance from the base in both sides

L'application du sol est recommandée à une distance de 5 mm de la base, des deux côtés

Se recomienda aplicar el suelo a una distancia de 5mm de la base, por ambos lados

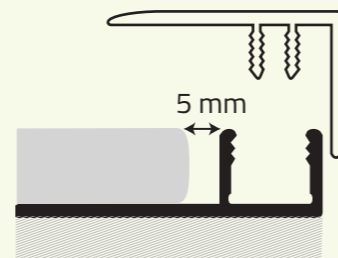









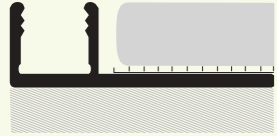

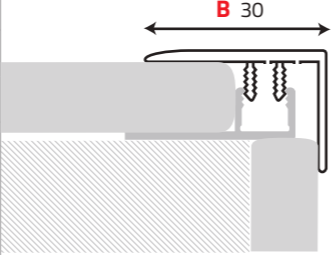
Pellicolato color legno/ Film-coated oak

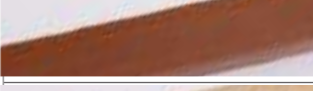

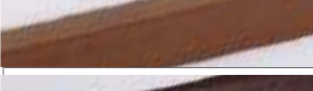
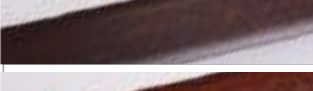



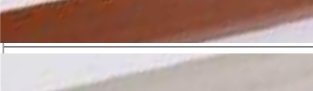
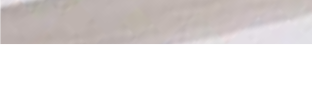

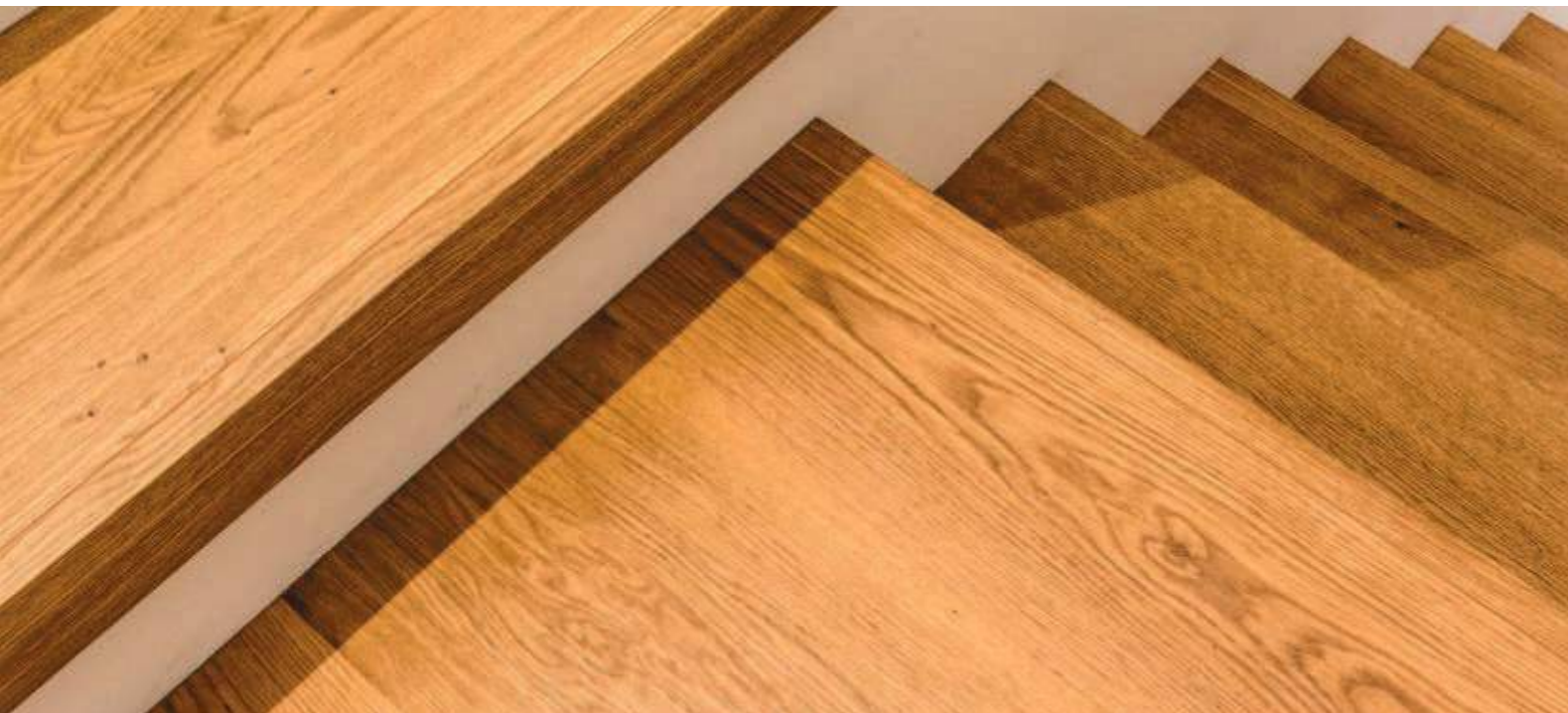







Pellicolato color legno/ Film-coated oak

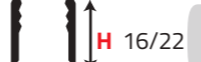

PARAPARC	Finitura- Finish		B.(mm)	EAN	Cod.	Caratteristiche	L (m)	Conf. Carton.	Ord.min
 <p>Scegli la tua base Choose your Base</p> <p>* Baseparc pag. 180</p> <p>Profilo con base non inclusa Profile with base not included</p> <p>Valutare l'altezza della base, se si ha tappetino da 2/3 mm The height of the base should be taken in count in case of 2/3 mm mat</p> 	 noce biondo blond walnut								
	 noce chiaro light walnut								
	 ciliegio cherry								
	 faggio silver silver beech								
	 rovere sbiancato bleached oak								
	 noce walnut								
	 wengè wengè								
	 merbau merbau								
	 acero bianco pale maple								
	 doussiè doussiè								
	 noce rosso red walnut								
	 acero bianco Swhite maple								



BASEPARC	Finitura- Finish	Range di applicazione	H. (mm)	(mm)	EAN	Cod.	Caratteristiche	L. (m)	Conf. Carton.	Ord.min.		
	baseparc		6/10	27	8013237025830	026A 	 	2,70	30	5		
			6/10	27	8013237044923	026A1 		0,90	30	5		
baseparc alta	naturale natural		10/16	27	8013237025847	026B 	 	2,70	30	5		
			10/16	27	8013237054380	026B2 		0,90	30	5		
baseparc altissima			16/22	27	8013237054779	026B3	 	0,90	30	5		
			16/22	27	8013237056759	026C			2,70	30	5	

Fissaggio della base al massetto con colla o viti (non incluse)

Fixing the base to the screed with glue or screws (not included)

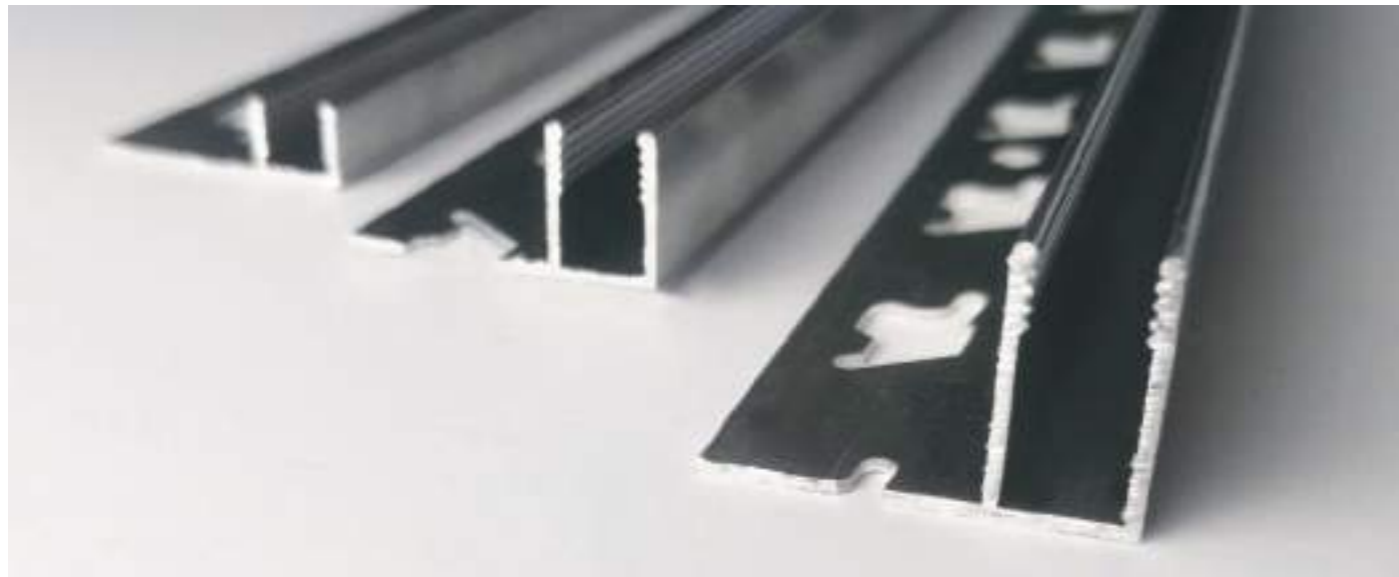
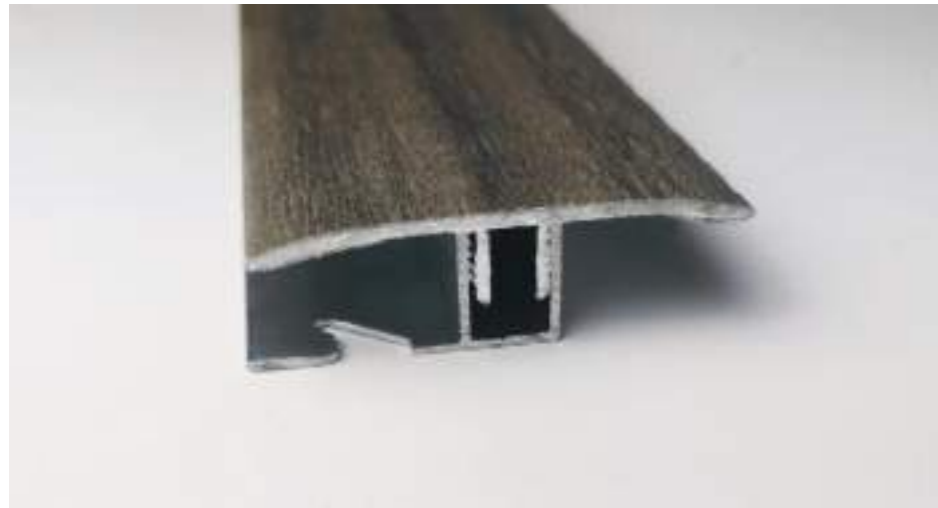

Kit Baseparc

* KIT PIATTOPARC B. 40mm forniti di base 6/10

* PIATTOPARC KIT Profiles supplied with 6/10mm base

* KIT SCIVOPARC B. 40mm forniti di base 6/10mm

* SCIVOPARC KIT Profiles supplied with 6/10mm base









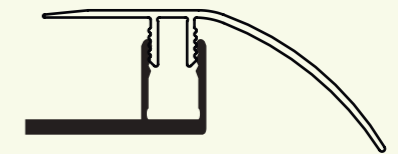
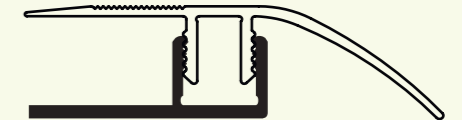
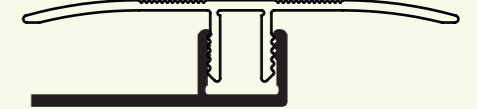

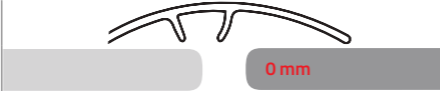







* KIT SCIVOPARC B. 52mm forniti di base 10/16mm

* SCIVOPARC KIT Profiles supplied with 10/16 mm base

* KIT TERMARC B. 30 mm forniti di base 6/10 mm

* TERMPARC KIT supplied with 6/10 mm base

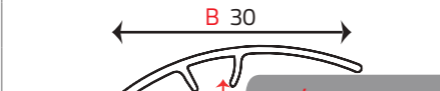
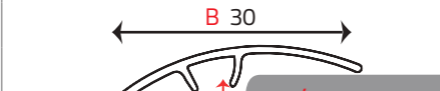
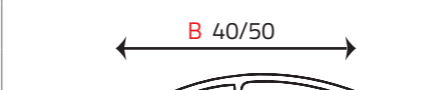
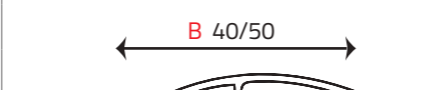
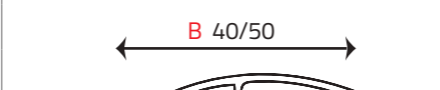

PIATTOLAM	Finitura- Finish	Range di applicazione		EAN	Cod.	Caratteristiche	L. (m)	Conf. - Carton	Min. ord.			
	argento anodizzato satinato satin anodised gold	 0 mm	30	8013237134907	027G8B/90 (FR)	                	0,90	30	5			
			40	8013237134228	024D3/90 (FR)		0,90	30	5			
			50	8013237134204	024D2/90 (FR)		0,90	30	5			
			30	8013237134792	027G8/90		1,80	30	5			
			40	8013237134808	027G9/90		1,80	30	5			
			50	8013237134815	027G9A/90		1,80	30	5			
	oro anodizzato satinato satin anodised gold	 max 4 mm	40	8013237134273	024D3/91 (FR)		0,90	30	5			
			30	8013237134846	027G8A/91		0,90	30	5			
			 B 30									
			 B 40/50									
			 max 5 mm									
			 max 5 mm									

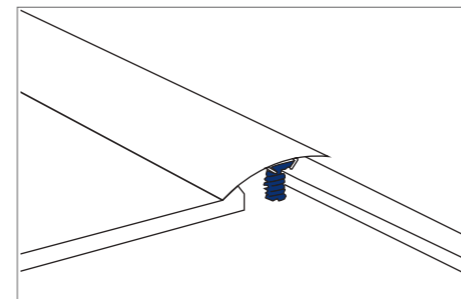
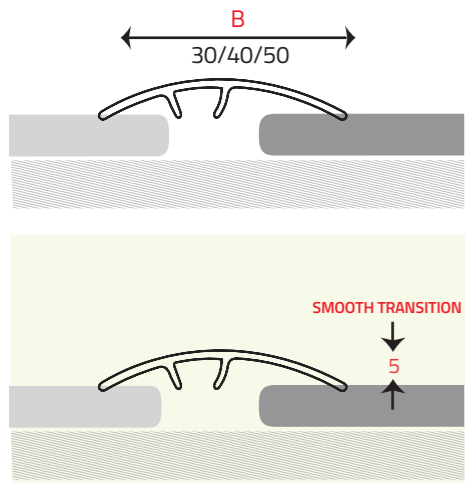

Sistema di montaggio con viti nascoste, incluse nell'articolo
 Installation system with hidden screws (included)
 Système de montage avec vis cachées, inclus dans l'article
 Sistema de montaje con tornillos ocultos, incluido en el artículo

Punti di forza Strengths

Adatto per risolvere i grandi problemi di dilatazione termica
 Suitable to solve tough thermal expansion issues
 Convient pour résoudre les problèmes importants de dilatation thermique
 Adecuado para resolver grandes problemas de dilatación térmica

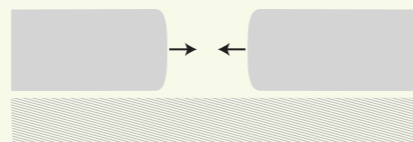

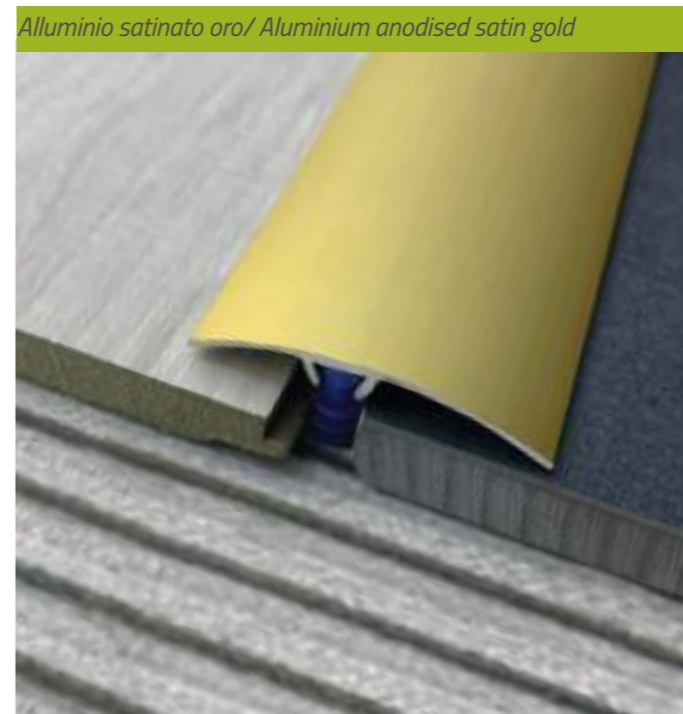
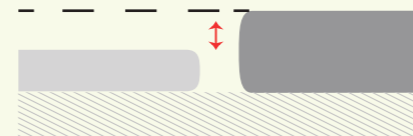

Adatto per risolvere problema di alti dislivelli
 Suitable to fix issues in floorings altitude differences
 Convient pour résoudre les problèmes de dénivèlement important
 Indicado para resolver problemas de desniveles en el piso

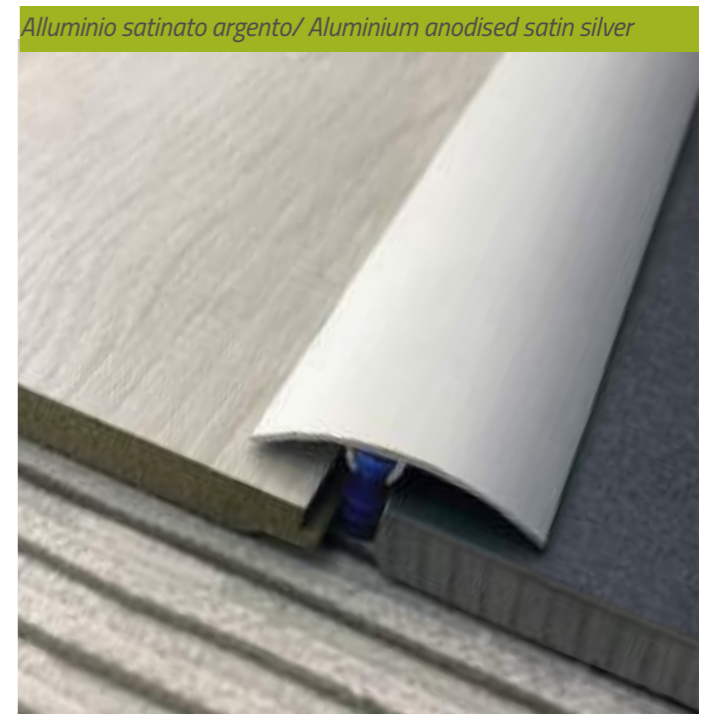

Alluminio satinato oro/ Aluminium anodised satin gold



Alluminio satinato argento/ Aluminium anodised satin silver

PIATTOLAM	Finitura- Finish	Range di applicazione	B.(mm)	EAN	Cod.	Caratteristiche	L (m)	Conf. Carton.	Ord.min		
	 ciliegio cherry		30	8013237134822	027G8A/134		0,90	30	5		
	 noce walnut		30	8013237134839	027G8A/136		0,90	30	5		
	 faggio beech		30	8013237134150	024B5/123		0,90	30	5		

Fissaggio e installazione

Infilare nelle apposite guide le viti nascoste fornite in dotazione.
Thread the hidden screws (included) in the appropriate drivings.

Forare il sottofondo corrispondenza delle viti inserite ed inserire un collante idoneo.
Drill the sub-base in correspondence with the applicated screws and applicate a proper glue.

Premere il profilo in modo da fissarlo al sottofondo e non lasciare spazio tra il profilo ed il rivestimento.
Gently press the profile to fix it to the sub-base and do not leave spaces between the profiles and the flooring.

Pulire accuratamente mediante spugna morbida e acqua l'eventuale collante eccedente, entro 10 minuti dall'applicazione.
Clean the excess of glue carefully with a soft sponge and water within 10 minutes from the application.

Rimuovere, ove presente, la pellicola protettiva per la salvaguardia della nitura del prodotto.
If present, remove the remaining protective film for the preservation of the product nish.

Pellicolato color legno/ Film-coated oak

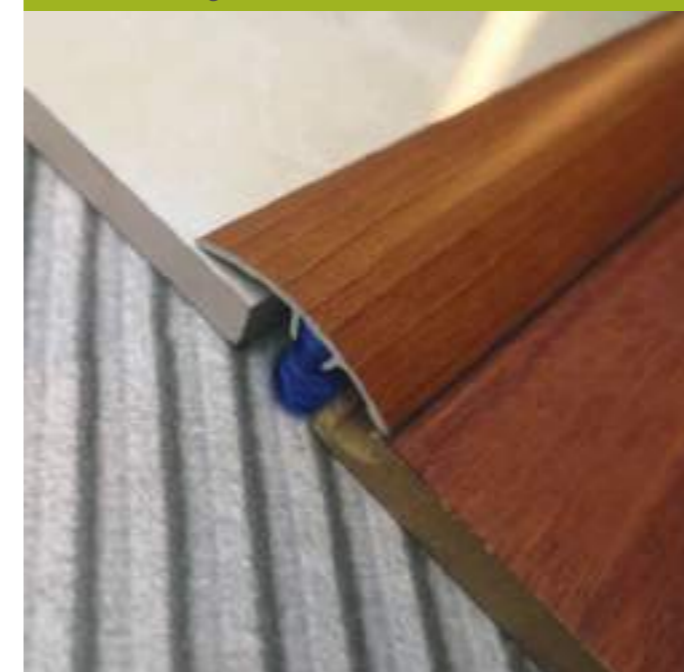

Pellicolato color legno/ Film-coated oak

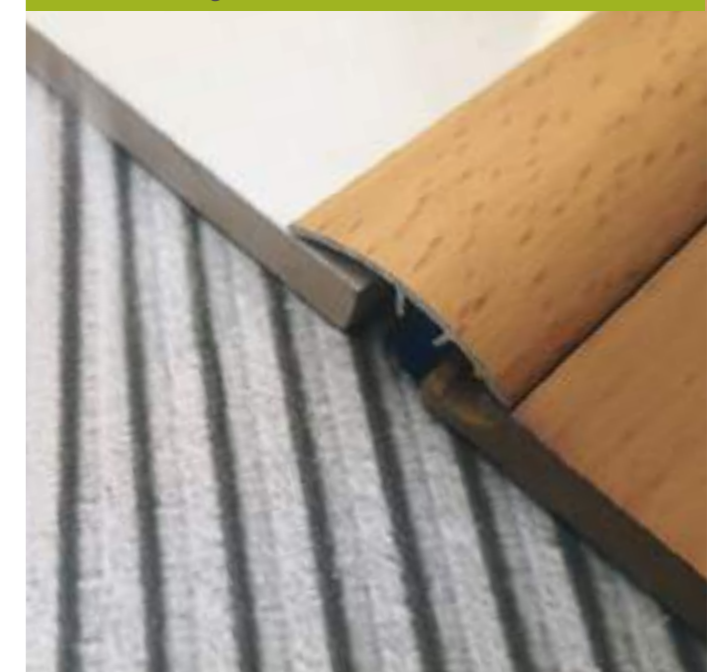

TERMLAM	Finitura- Finish	Range di applicazione	B. (mm)	EAN	Cod.	Caratteristiche	L. (m)	Conf. - Carton	Min. ord.
	argento anodizzato satinato anodised satin silver		30	8013237135621	027EX1/90		1,00	30	5
	oro anodizzato satinato anodised gold satin		30	8013237134280	027EX1/91		1,00	30	5

SOTTOPOSA - UNDERTILE

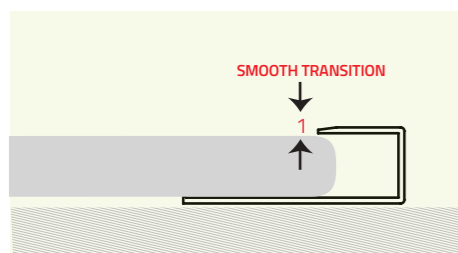
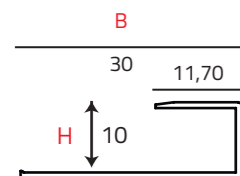

Profilo con pellicola protettiva
Profile with film



Profilo forato con viti incluse
Drilled profile with screws included



Profilo blisterato
Profile with blister

Alluminio argento satinato/ Anodised satin silver



Alluminio oro satinato/ Anodised satin gold

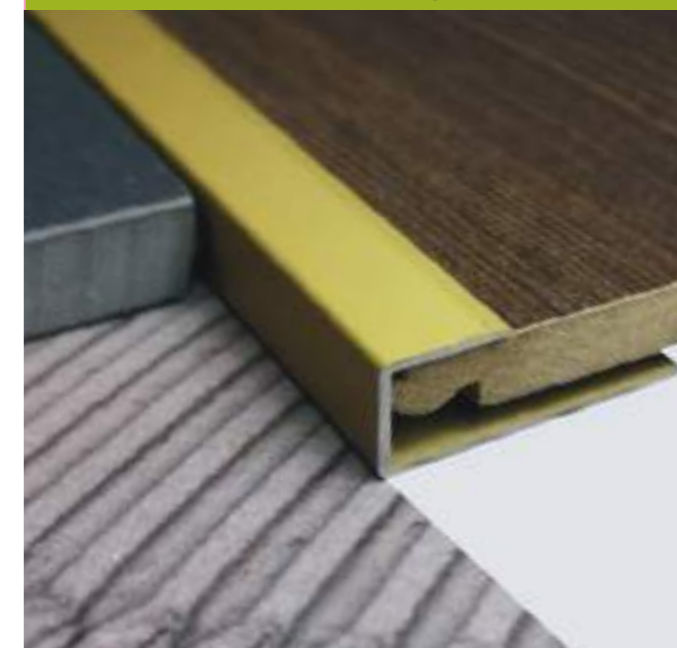

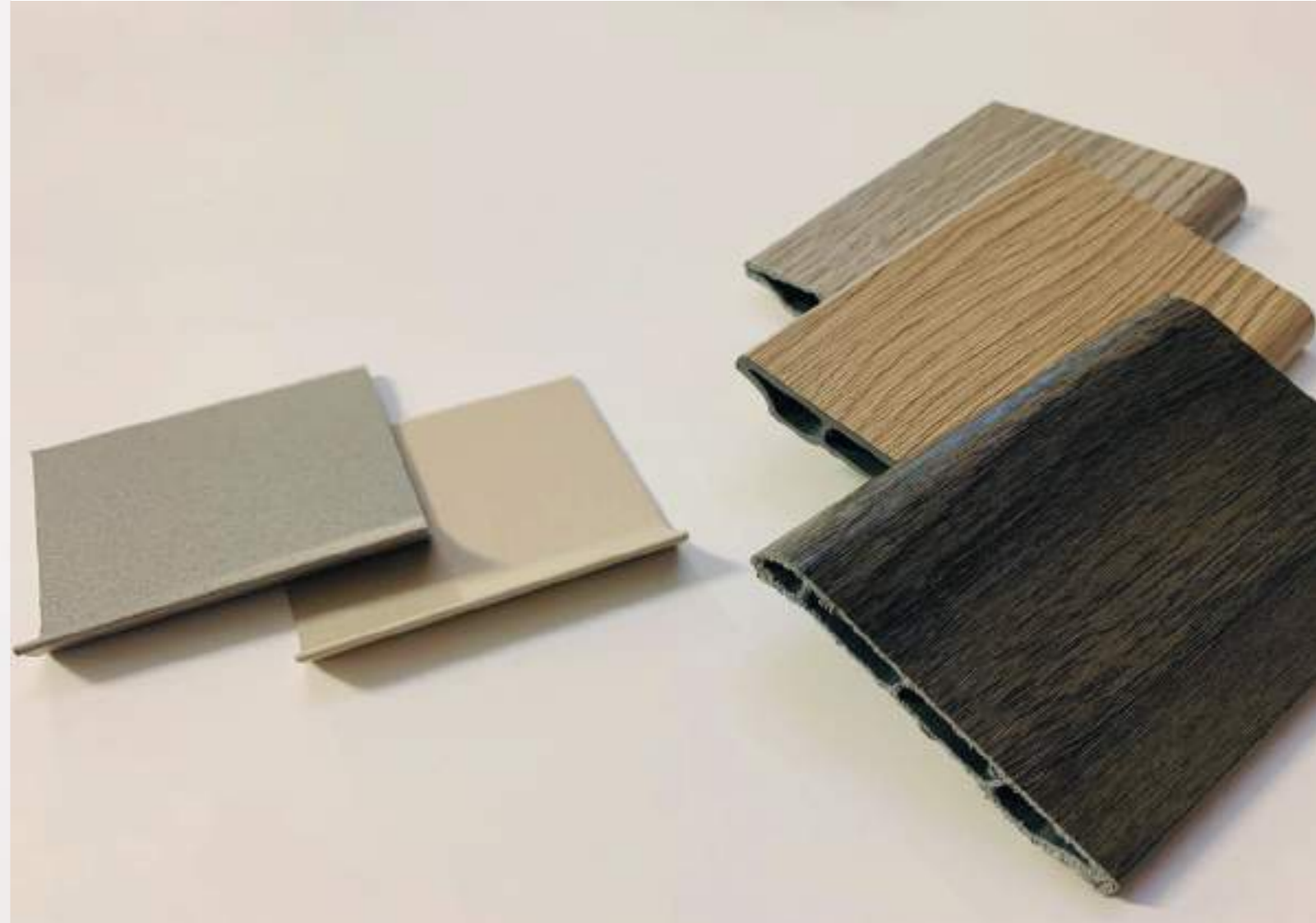

Battiscopa

Skirtings/ Plinthe/Rodapié

Realizzati e progettati per una facile "posa fai da te", i battiscopa arcansas sono flessibili e resistenti, impermeabili e antimuffa. Disponibili anche nella versione adesiva.

Vantaggi:

- Altamente decorativi
- Facilità di applicazione con adesivo o silicone
- Perfettamente abbinabili con profili per laminati e parquet e profili per rivestimento/fai da te in alluminio effetto pietra
- Funzione di protezione per la parete
- Scarsa manutenzione

Designed and produced for an easy DIY application, Arcansas' skirting board are flexible and resistant, waterproof and anti-mold. The adhesive version of these products is available.

Strong points:

- Highly decorative
- Easy to applicate with adhesive or silicon
- Match perfectly with profiles for laminate floorings and parquet, stone-effect covering profiles and DIY profiles
- Protect the wall
- Little maintenance is required

Fabriquéés et conçues pour une installation facile à faire soi-même, les plinthes Arcansas sont souples et résistantes, étanches et anti-moisissures. Egalement disponible en version adhésive.

Avantages:

- Très décoratives
- Application facile avec adhésif ou silicone
- Parfaitement combinable avec des profilés pour stratifié et parquet et des profilés de revêtement/bricolage en aluminium effet pierre
- Fonction de protection murale
- Faible entretien

Fabricados y diseñados para una fácil instalación "hágalo usted mismo", los rodapiés arcansas son flexibles y resistentes, impermeables y antimoho. También disponible en versión adhesiva.

Ventajas:

- Altamente decorativo
- Fácil aplicación con adhesivo o silicona.
- Perfectamente combinable con perfiles para laminados y parquet y perfiles para revestimiento/bricolaje en aluminio con efecto piedra
- Función de protección de la pared
- Se necesita de poco mantenimiento

BATILAM



Finitura- Finish		H. (mm)	EAN	Cod.	Caratteristiche	L (m)	Conf. Carton.	Ord.min
New	bianco tinta unita solid color white	70	8013237145941	1702/01		2,50	10	10
New	colore legno grigio DB2 color wood DB2 grey	70	8013237146061	1702/144		2,50	10	10
New	colore legno faggio sbiancato color wood bleached beech	70	8013237145965	1702/145		2,50	10	10
New	colore legno rovere chiaro color wood light oak	70	8013237145989	1702/146		2,50	10	10
New	colore legno rovere scuro color wood dark oak	70	8013237145972	1702/147		2,50	10	10
New	colore legno noce naturale color wood natural walnut	70	8013237145958	1702/148		2,50	10	10
New	colore legno faggio naturale color wood natural beech	70	8013237145996	1702/149		2,50	10	10
New	colore legno bamboo sbiancato color wood bleached bamboo	70	8013237146054	1702/150		2,50	10	10

Perfect Matching

ARCANSAS ha progettato un sistema completo di profili per ambienti in parquet e laminati.
 Arcansas has designed a complete system of profiles for settings where the laminate flooring and parquet are present.

Tutte le finiture legno sono disponibili sia per batilam, che per le varie forme di profili parquet.
 All wooden finishing are available either for "batilam", either for any other shape of parquet profiles.

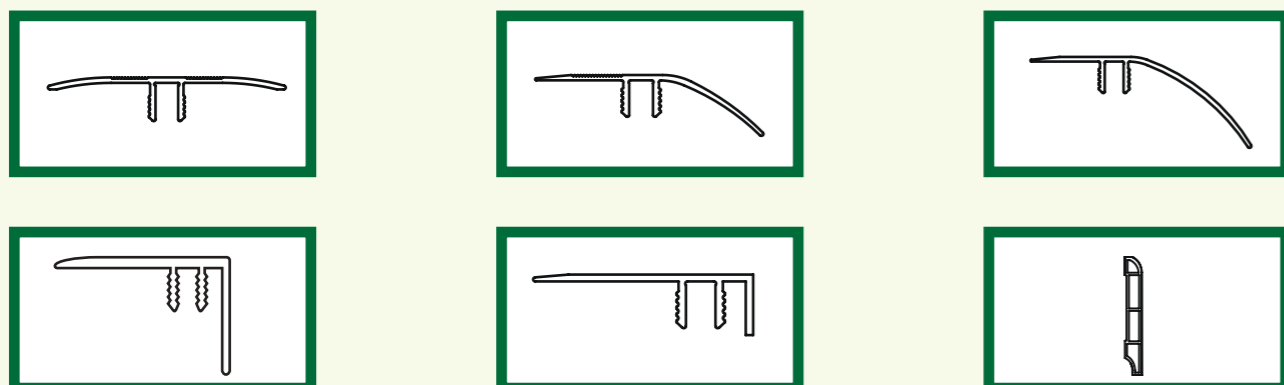



BATILAM



Finitura- Finish	
New	colore legno magellan ice color wood magellan ice
New	colore legno rovere KY color wood KY oak
New	colore legno acero color wood maple
New	colore legno woodec cement color wood woodec cement
New	colore legno alkorcell kain white color wood alkorcell kain white
New	colore legno woodec turner color wood woodec turner

H. (mm)	EAN	Cod.	L (m)	Caratteristiche	Conf. Carton.	Ord.min
70	8013237146016	1702/152	2,50		10	10
70	8013237146078	1702/153	2,50		10	10
70	8013237146009	1702/154	2,50		10	10
70	8013237146023	1702/155	2,50		10	10
70	8013237146030	1702/156	2,50		10	10
70	8013237146047	1702/157	2,50		10	10

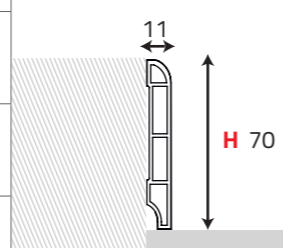

Punti di forza
Strengths

Non si gonfia a contatto con l'acqua

Does not expand in case of water contact.

Il ne gonfle pas au contact de l'eau.

No se hincha en contacto con el agua.

Articolo disponibile, su richiesta, anche nei seguenti colori:

The item is also available, on request, in the following colours:

Article également disponible, sur demande, dans les couleurs suivantes:

Artículo también disponible, bajo petición, en los siguientes colores:



Pellicolato color legno/ Film-coated oak



Pellicolato color legno/ Film-coated oak

BATIAL	Finitura- Finish		H.(mm)	EAN	Cod.	Caratteristiche	L (m)	Conf. Carton.	Ord.min		
	anodizzato satinato argento satin anodised silver		60	8013237005405	046C10/90		2,00	10	5		*
			60	8013237005559	046C7/90		2,00	10	5		

* Kit batial pag. 194
 * Kit Batial pag. 194

Perfect Matching



KIT BATIAL



046C11/90



046C11/90
Angolo interno
internal corner



046C12/90

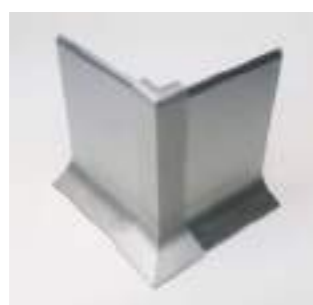

046C12/90
Angolo esterno
External corner



046C14/90



046C14/90
Giunto di raccordo
Connection joint







046C19/90
Terminale sx
Terminal left

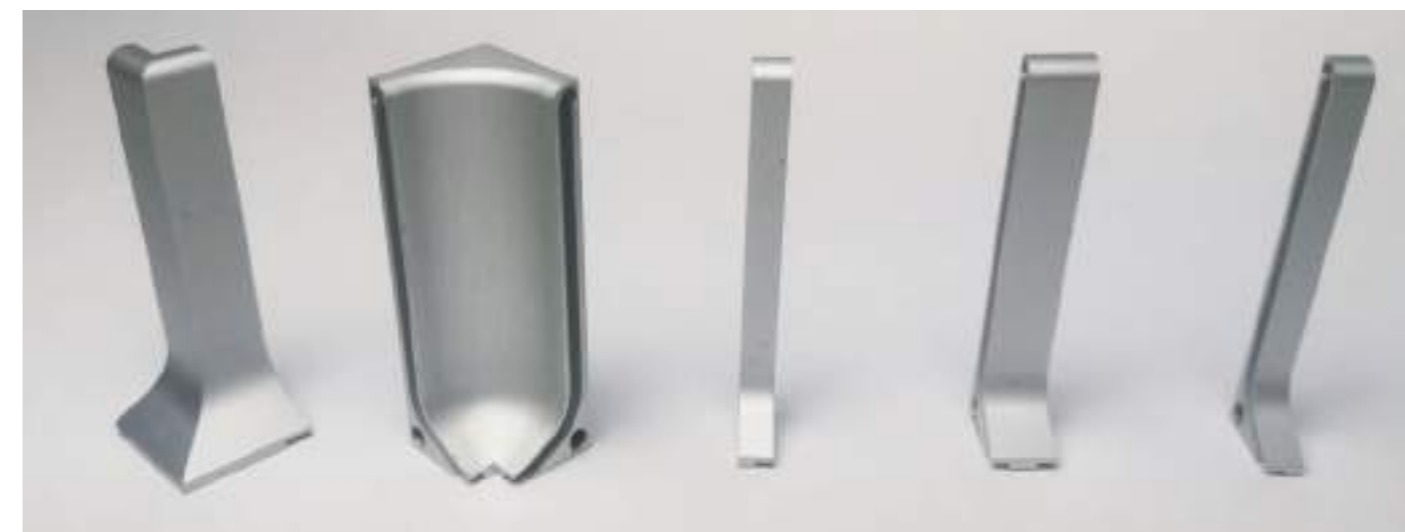
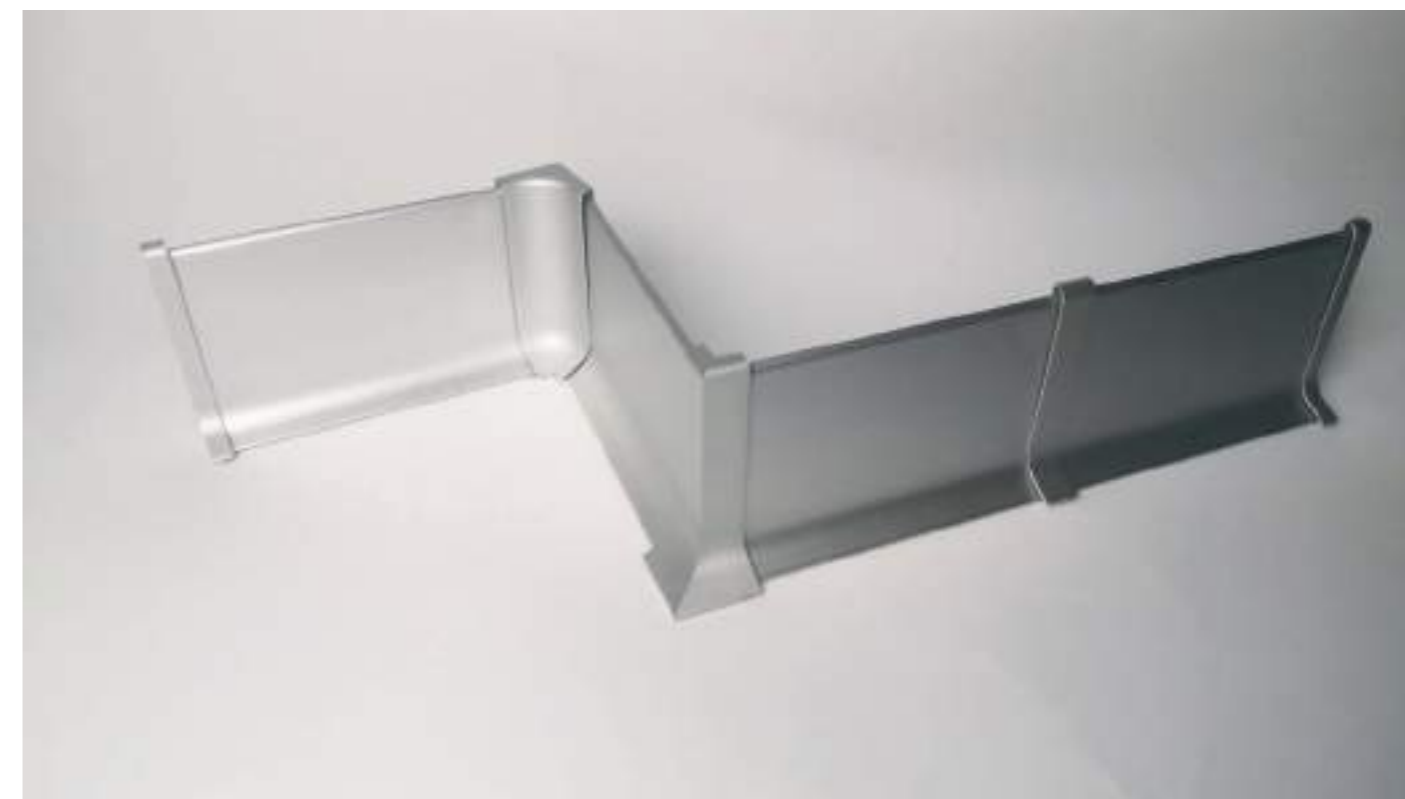

046C18/90
Terminale dx
Terminal right

	H.(mm)	EAN	Cod.	Pz/Blister	Ord.min
anodizzato satinato argento					
satin anodised silver					

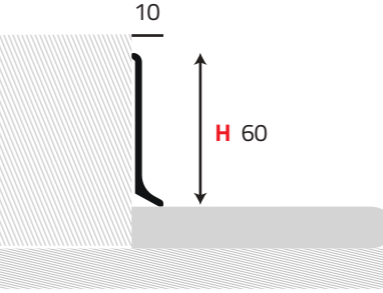

BATIAL			H. (mm)	EAN	Cod.	Caratteristiche	L (m)	Conf. Carton.	Ord.min		
 <p>* Kit batial pag. 198-200-202-204 206</p> <p>* Batial Kit pag. 198-200-202-204 206</p>	New	verniciato effetto pietra ruggine stone finishing painting rust	62	8013237145378	046C10/100			2,00	10	5	
	New	verniciato effetto pietra beige stone finishing painting beige	62	8013237145385	046C10/101			2,00	10	5	
	New	verniciato effetto pietra sabbia stone finishing painting sand									
	New	verniciato effetto pietra cemento stone finishing painting concrete	62	8013237145408	046C10/103			2,00	10	5	
	New	verniciato effetto pietra fumo di Londra stone finishing painting London	62	8013237145415	046C10/104			2,00	10	5	
	New	verniciato effetto pietra antracite stone finishing painting anthracite	62	8013237145422	046C10/105			2,00	10	5	

Perfect Matching

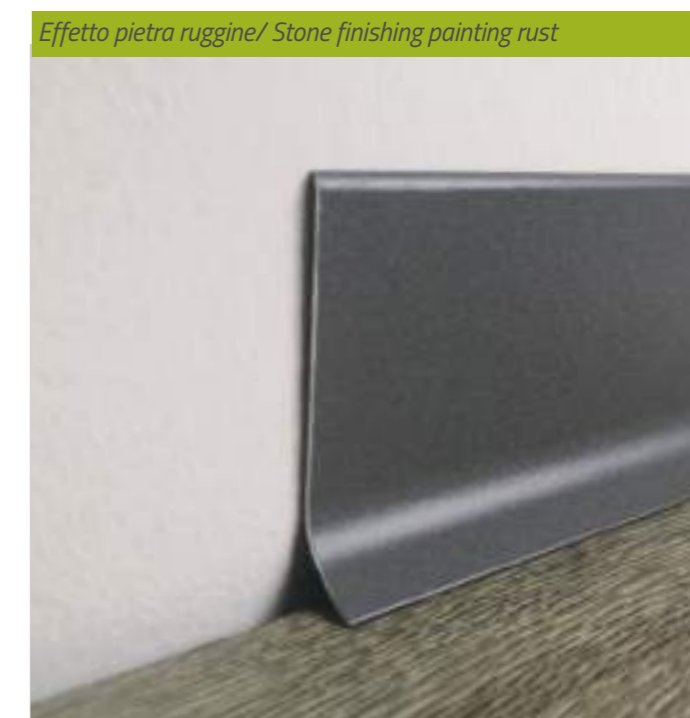
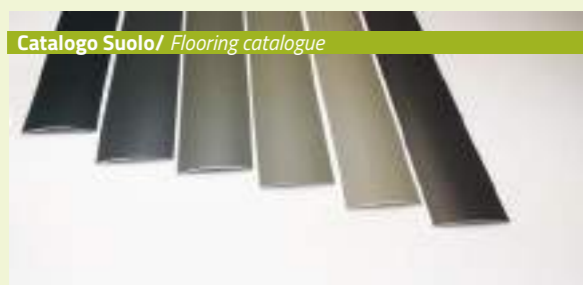

KIT BATIAL



046C11/101

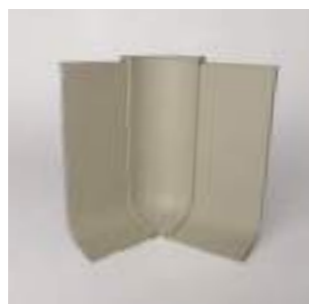

046C11/101
Angolo interno
Internal corner



046C12/101



046C12/101
Angolo esterno
External corner



046C14/101



046C14/101
Giunto di raccordo
Connection joint



046C19/101
046C18/90



046C19/90
Terminale sx
Terminal left



046C18/90
Terminale dx
Terminal right

	H.(mm)	EAN	Cod.	Pz/Blister	Ord.min
 verniciato effetto pietra beige stone finishing painting beige					



KIT BATIAL



046C11/102



046C11/102
Angolo interno
Internal corner



046C12/102



046C12/102
Angolo esterno
External corner



046C14/102



046C14/102
Giunto di raccordo
Connection joint



046C19/102
046C18/102



046C19/102
Terminale sx
Terminal left



046C18/102
Terminale dx
Terminal right

	H.(mm)	EAN	Cod.	Pz/Blister	Ord.min
 verniciato effetto pietra sabbia stone finishing painting sand					



KIT BATIAL



046C11/103

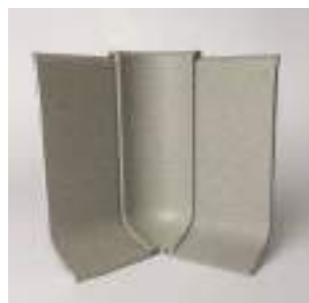

046C11/103
Angolo interno
Internal corner



046C12/103



046C12/103
Angolo esterno
External corner



046C14/103



046C14/103
Giunto di raccordo
Connection joint



046C19/103
046C18/103



046C19/103
Terminale sx
Terminal left



046C18/103
Terminale dx
Terminal right

	H.(mm)	EAN	Cod.	Pz/Blister	Ord.min
 verniciato effetto pietra cemento stone finishing painting concrete					

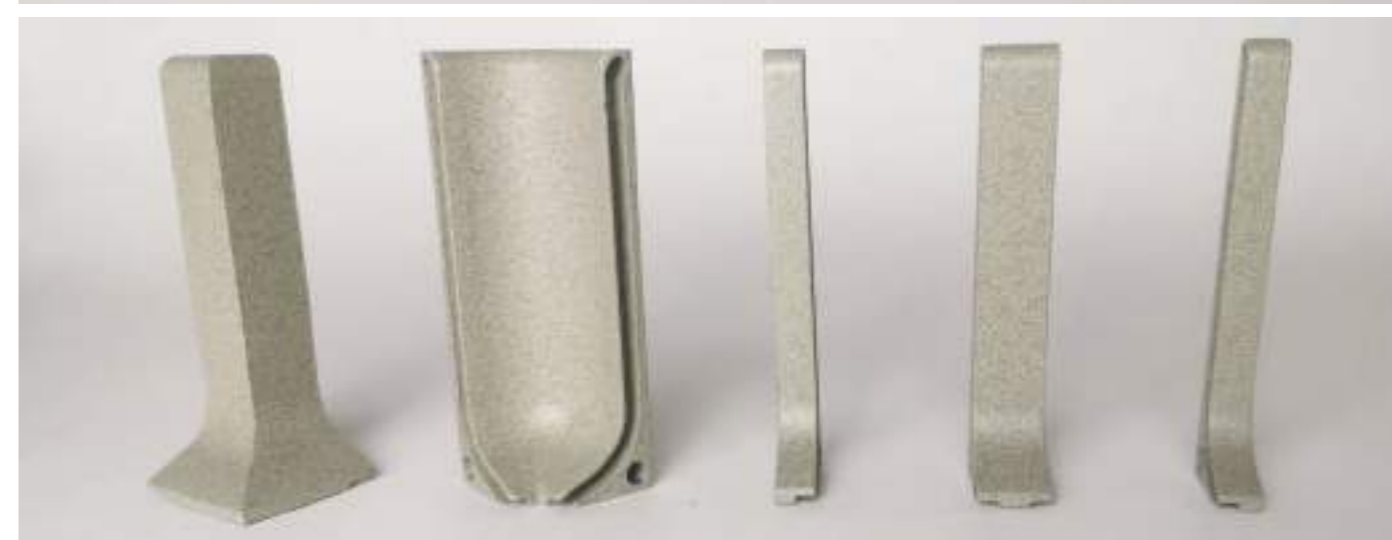
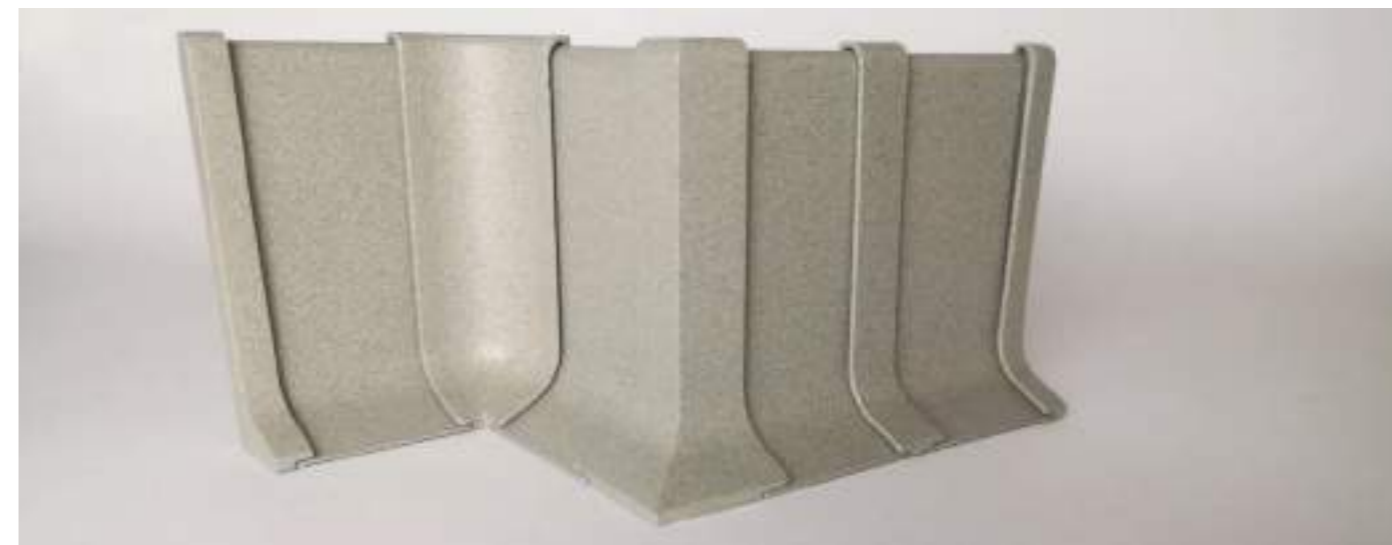

KIT BATIAL



046C11/104



046C11/104
Angolo interno
Internal corner



046C12/104



046C12/104
Angolo esterno
External corner



046C14/104

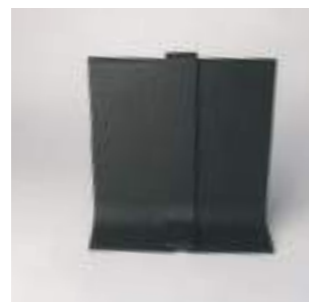

046C14/104
Giunto di raccordo
Connection joint



046C19/104
046C18/104



046C19/104
Terminale sx
Terminal left



046C18/104
Terminale dx
Terminal right

	H.(mm)	EAN	Cod.	Pz/Blister	Ord.min
New verniciato effetto pietra fumo di Londra stone finishing painting London					

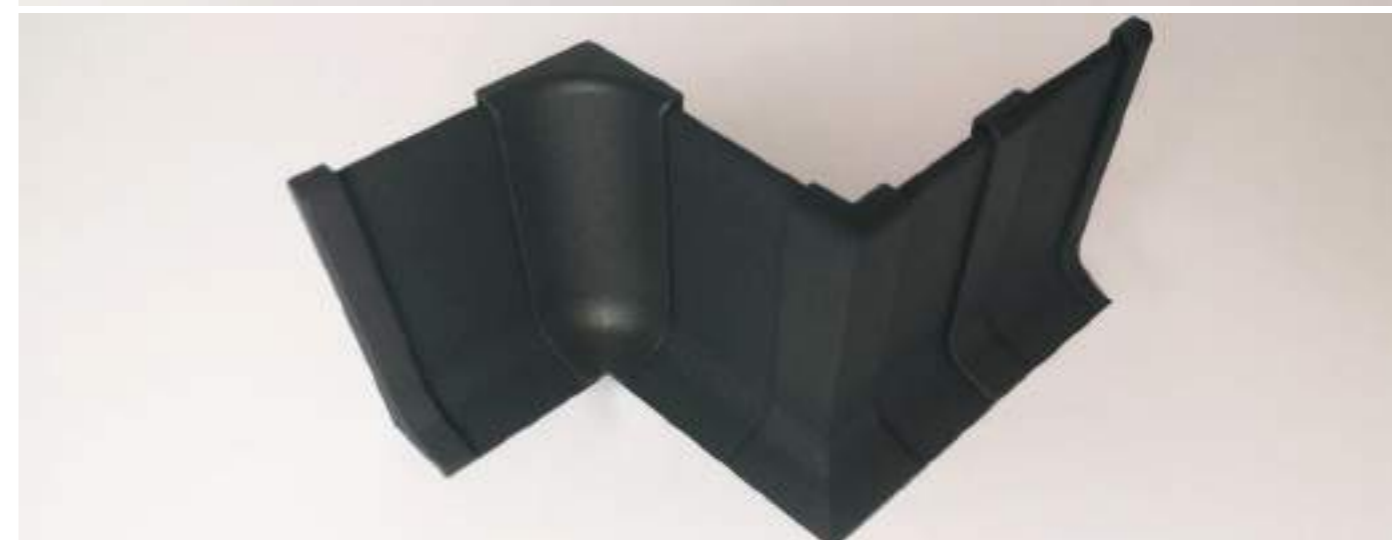
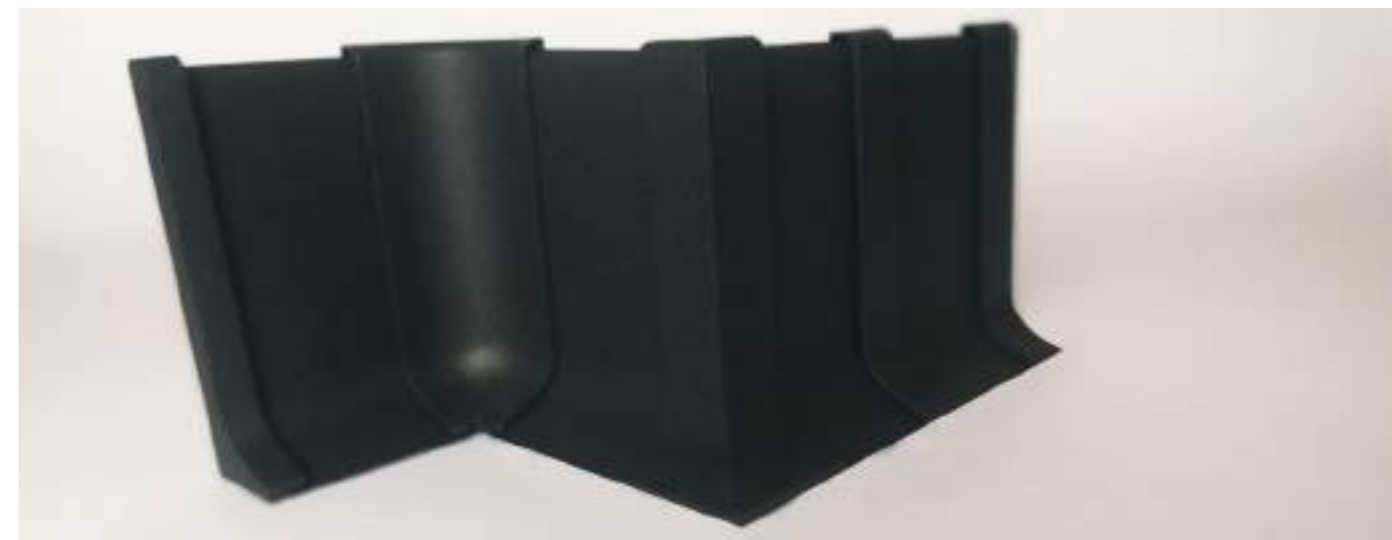

KIT BATIAL



046C11/105

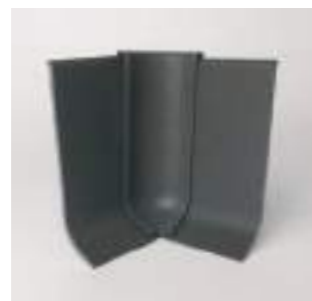

046C11/105
Angolo interno
Internal corner



046C12/105

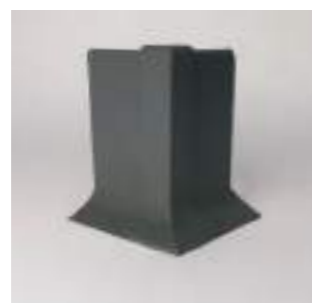

046C12/105
Angolo esterno
External corner



046C14/105



046C14/105
Giunto di raccordo
Connection joint



046C19/105
046C18/105



046C19/105
Terminale sx
Terminal left



046C18/105
Terminale dx
Terminal right

	H.(mm)	EAN	Cod.	Pz/Blister	Ord.min
 verniciato effetto pietra antracite stone finishing painting anthracite					

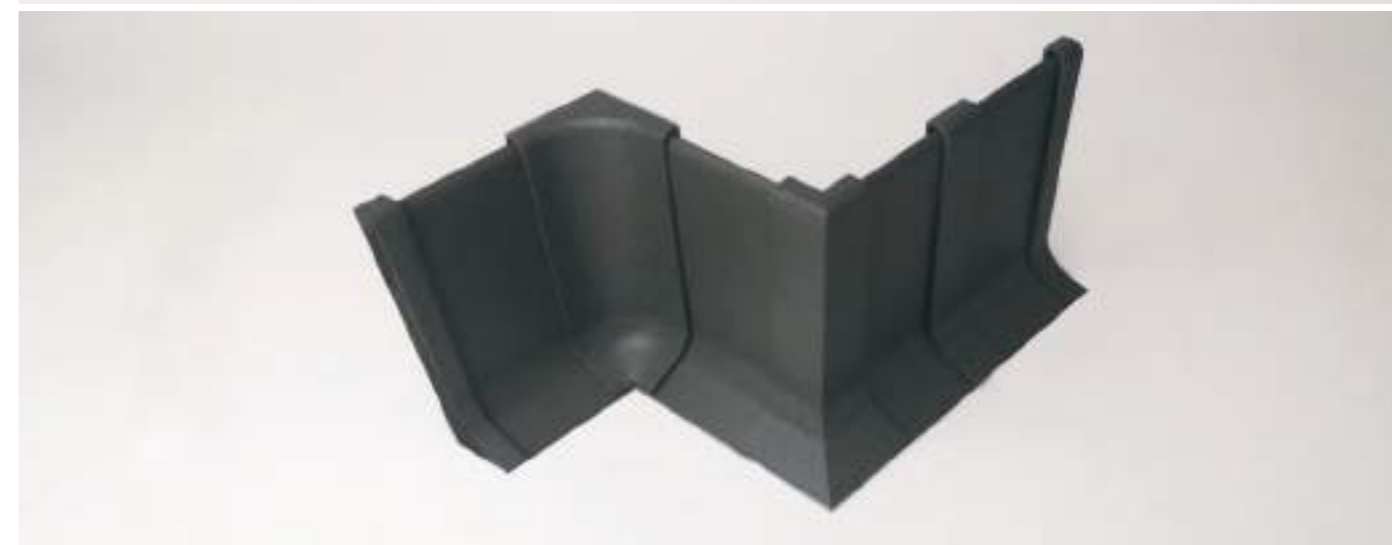
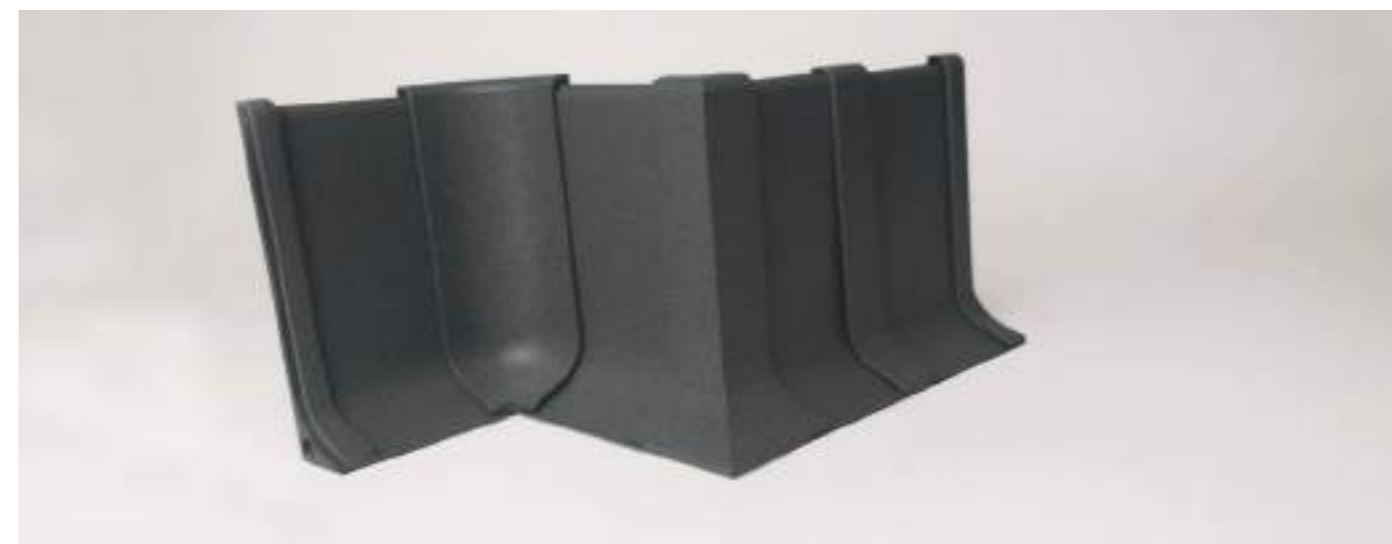

KIT BATIAL



046C11/100



046C11/100
Angolo interno
Internal corner



046C12/100

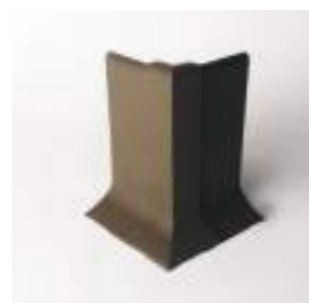

046C12/100
Angolo esterno
External corner



046C14/100



046C14/100
Giunto di raccordo
Connection joint



046C19/100
046C18/100



046C19/100
Terminale sx
Terminal left



046C18/100
Terminale dx
Terminal right

	H.(mm)	EAN	Cod.	Pz/Blister	Ord.min
New verniciato effetto pietra sabbia stone finishing painting sand					

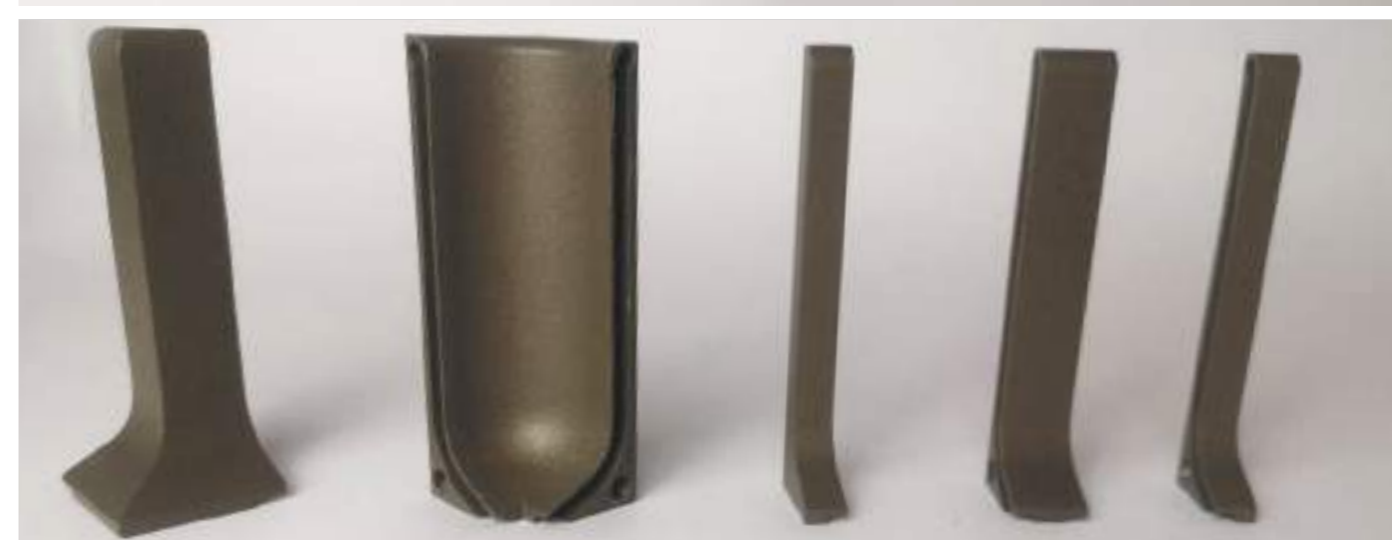
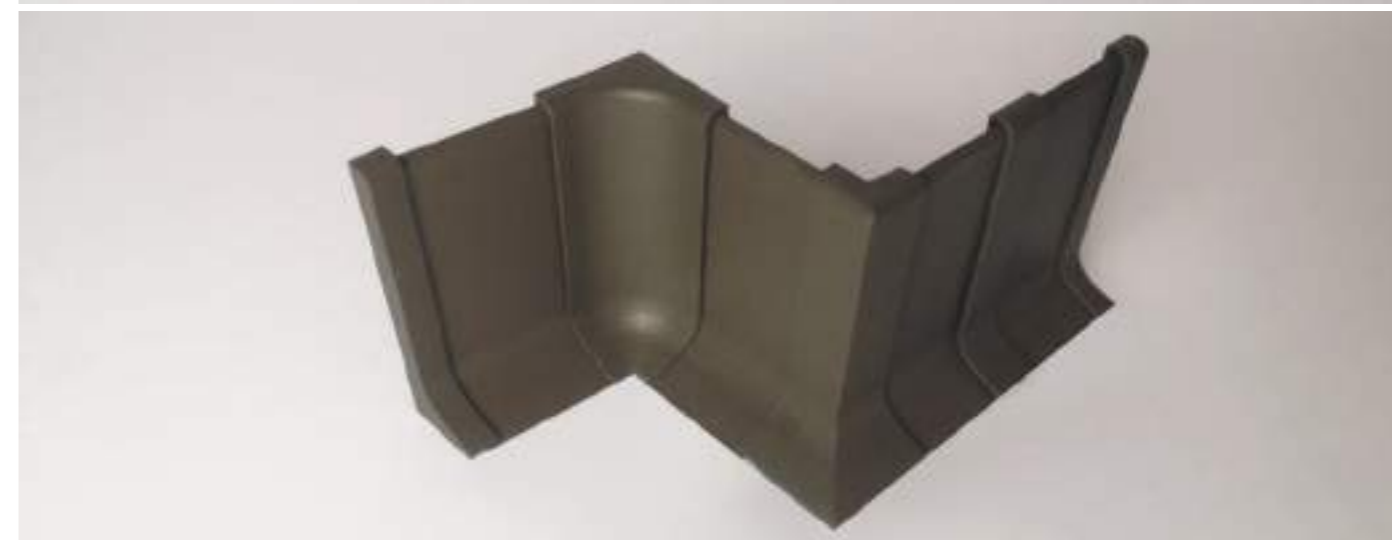
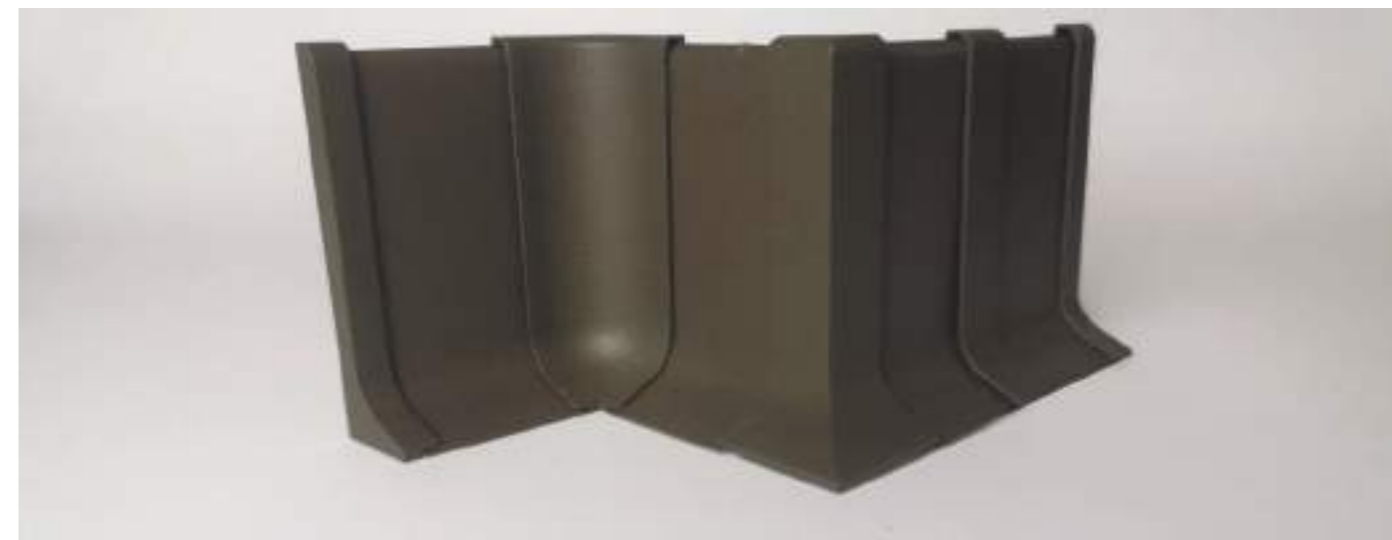









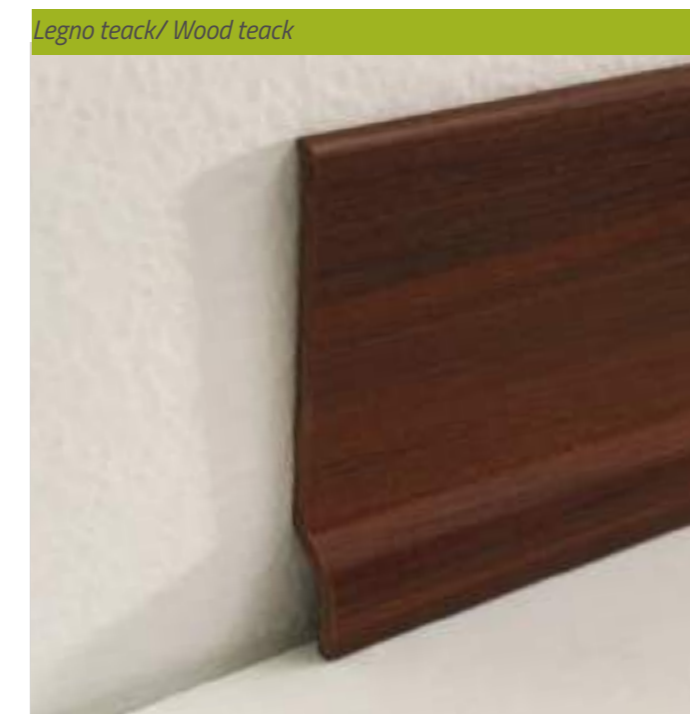
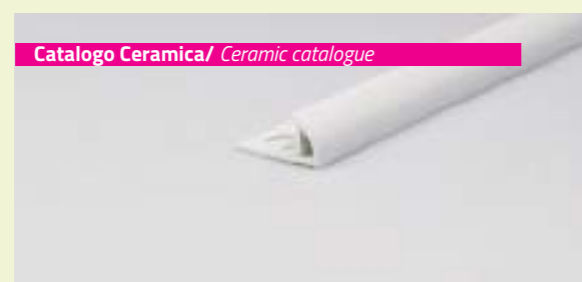

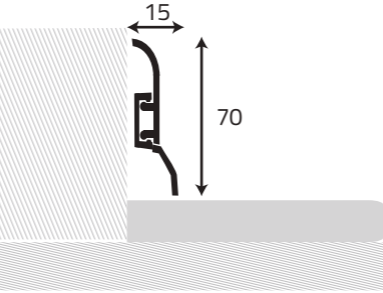

BATIPLAST

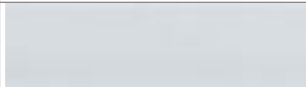







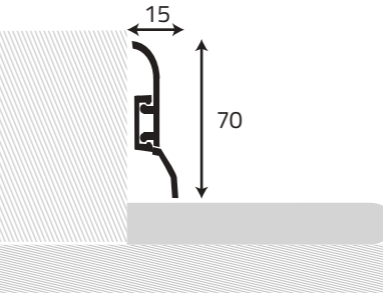

Finitura- Finish			H. (mm)	EAN	Cod.	Caratteristiche	L (m)	Conf. Carton.	Ord.min
	bianco tinta unita solid color white		65	8013237017019	1701/01		2,00	20	10
	grigio chiaro tinta unita solid color pale grey		65	8013237017002	1700/01		2,00	20	10
	grigio scuro tinta unita solid color dark grey		65	8013237017132	1701/03		2,00	20	10
	nero tinta unita solid color black		65	8013237170035	1700/03		2,00	20	10
	colore legno noce chiaro color wood light walnut		65	8013237170141	1701/04		2,00	20	10
	colore legno mogano color wood mahogany		65	8013237017217	1701/15		2,00	20	10
	colore legno noce scuro color wood dark walnut		65	8013237017200	1701/40		2,00	20	10
	colore legno teack color wood teack		65	8013237017194	1701/41		2,00	20	10
			65	8013237017149	1701/42		2,00	20	10
			65	8013237015893	1700/42		2,00	20	10
			65	8013237031435	1701/43		2,00	20	10

Perfect Matching

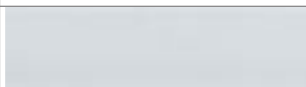

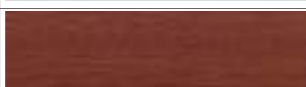
PIWOODPASS		Finitura- Finish		BxH. (mm)	EAN	Cod.	Caratteristiche	L (m)	Conf. Carton.	Ord.min				
		laminato legno grigio wood laminate grey												
		laminato legno nero wood laminate black												
		laminato bianco venato wood laminate veined white												
		laminato ciliegio wood laminate cherry												
		laminato noce wood laminate walnut												
		laminato noce scuro wood laminate dark walnut												

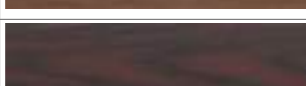
EXTERNAL CORNERS		Finitura- Finish		BxH. (mm)	EAN	Cod.	Caratteristiche	L (m)	Conf. Carton.	Ord.min				
		laminato legno grigio wood laminate grey												
		laminato legno nero wood laminate black												
		laminato bianco venato wood laminate veined white												
		laminato ciliegio wood laminate cherry												
		laminato noce wood laminate walnut												
		laminato noce scuro wood laminate dark walnut												

INTERNAL CORNERS



Finitura- Finish			BxH. (mm)	EAN	Cod.	Caratteristiche	L (m)	Conf. Carton.	Ord.min		
	laminato legno grigio wood laminate grey										
	laminato legno nero wood laminate black										
	laminato bianco venato wood laminate veined white										
	laminato ciliegio wood laminate cherry										
	laminato noce wood laminate walnut										
	laminato noce scuro wood laminate dark walnut										

R END CAP



Finitura- Finish			BxH. (mm)	EAN	Cod.	Caratteristiche	L (m)	Conf. Carton.	Ord.min		
	laminato legno grigio wood laminate grey										
	laminato legno nero wood laminate black										
	laminato bianco venato wood laminate veined white										
	laminato ciliegio wood laminate cherry										
	laminato noce wood laminate walnut										
	laminato noce scuro wood laminate dark walnut										

TERMINALE SX



Finitura- Finish			BxH. (mm)	EAN	Cod.	Caratteristiche	L (m)	Conf. Carton.	Ord.min		
	laminato legno grigio wood laminate grey										
	laminato legno nero wood laminate black										
	laminato bianco venato wood laminate veined white										
	laminato ciliegio wood laminate cherry										
	laminato noce wood laminate walnut										
	laminato noce scuro wood laminate dark walnut										

PIATTOCANAL

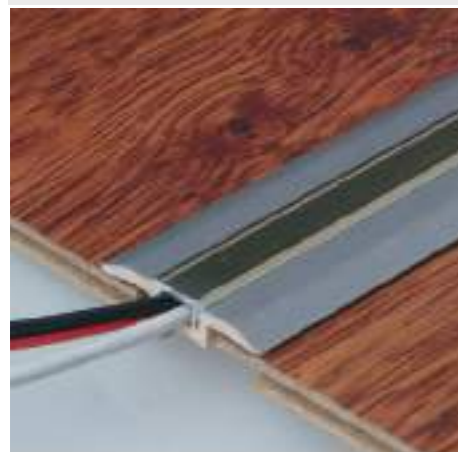

SOLO PER CAVI DI RETE E LOW VOLTAGE

For Network And Low Voltage Cables Only

Finitura- Finish			(mm)	EAN	Cod.	Caratteristiche	L (m)	Conf. Carton.	Ord.min	€/m	€/pz
	PVC con inserto alluminio anodizzato oro perlato faggio PVC with pearly gold aluminium insert beech										
	PVC con inserto alluminio anodizzato oro perlato rovere PVC with pearly gold aluminium insert oak										
	PVC con inserto alluminio anodizzato oro perlato ciliegio PVC with pearly gold aluminium insert cherry										
	PVC con inserto alluminio anodizzato oro perlato alluminio PVC with pearly gold aluminium insert aluminium										

products / **product**

the character is recognized by its profile

4 BUSINESS AREAS

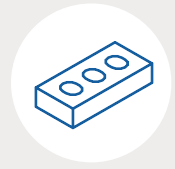

building dealers
revendeurs bâtiment
revendedores de materiales
de construcción



hardware
quincaillerie
ferretería



ceramic dealers
revendeurs carrelage
revendedores de cerámicas



large retail chains
GDO
GDO

The profiles are not simple metal rods for us, but a starting point of a **tailor-made project for each customer**, that we accompany passionately along the full sales process. Placed in our **display systems** they become the do-it-yourself winning solution.

We offer profiles in most different materials and finishings, to ensure that the customer chooses the most suitable for his needs. From ceramics to sanitary, floor and do-it-yourself. A **wide choice of colours** is repeated in all the collections to offer **depth and range synergy**.

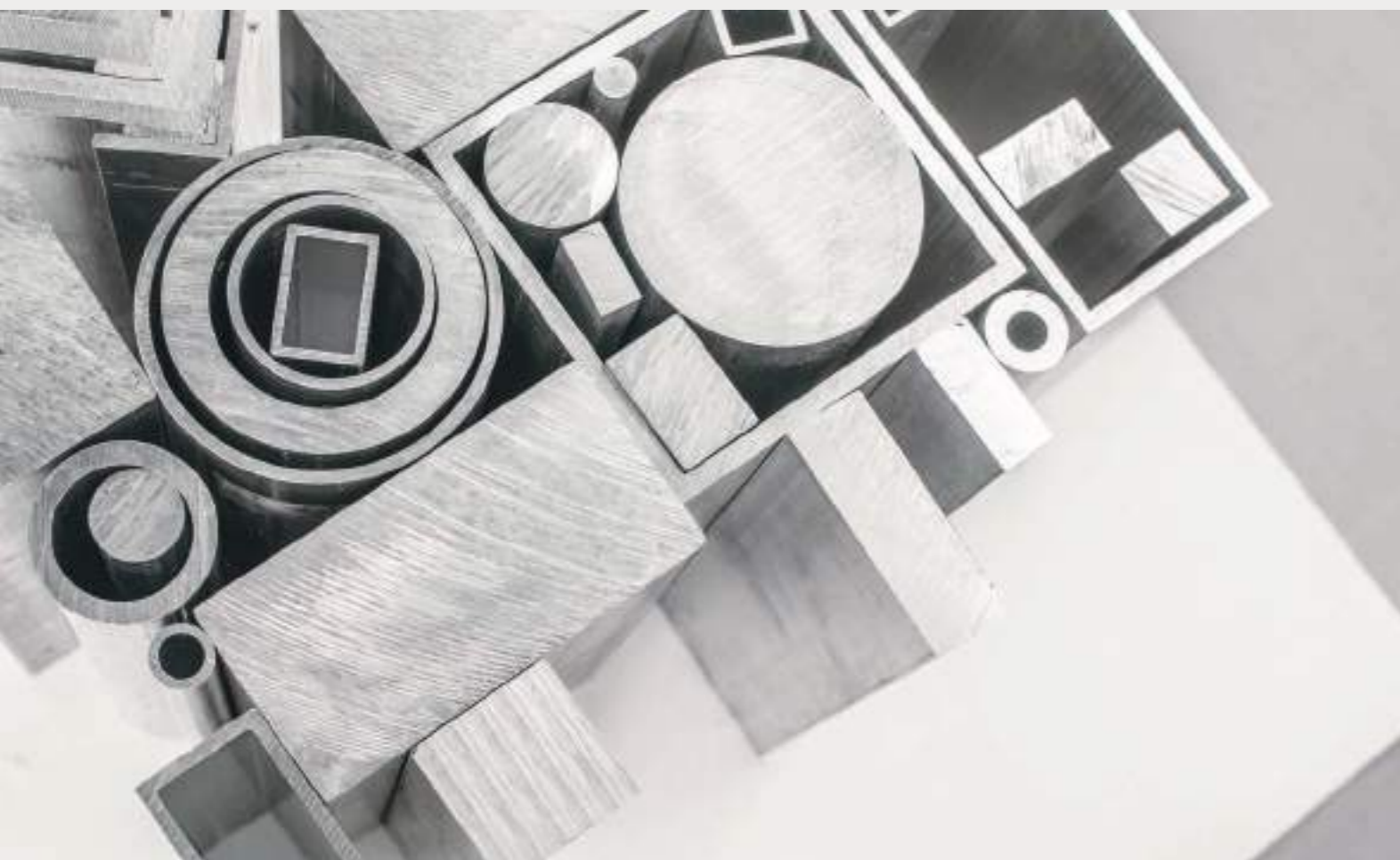

Profiles for tiling

For this product range ask for other Arcansas catalogues

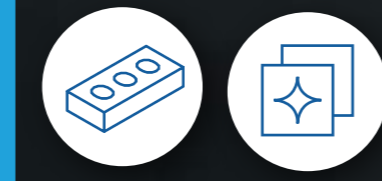

Hygienic cove profiles

For this product range ask for other Arcansas catalogues



Flooring profiles

For this product range ask for other Arcansas catalogues

PRODUCT RANGE IN THIS CATALOGUE





Profiles for hardware/diy



Profiles for tiling



-  **Facilitate** the installation and increase life time of the tile

-  **Hide** the rough outer edge of the tile

-  **Make safe and finish** the external edges of columns, niches and shelves

-  Ideal for **wall** and **floor**

-  Available in **stainless steel, aluminum** and **PVC** to meet the needs of any project



Flooring profiles

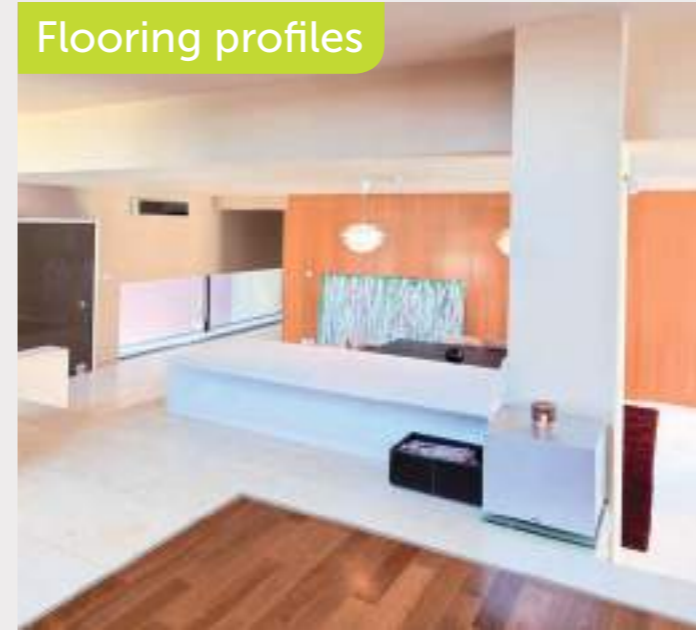

-  **They join and harmonize** coplanar floors or with level differences

-  **Non-slip knurled surface**

-  Adhesive fixing for a **do-it-yourself, quick and simple installation**

-  **Fixing with rails** suitable for wooden floors

-  **Safe fixing** for high stability in civil and high traffic environments

-  **Fixing screws included** of the same colour of the matched profile





Hygienic cove profiles



-  **Prevent water and mold from infiltrating** through the wall edge of the shower, tub and sink

-  **Conceal the sealant** that deteriorates over time

-  Concave shape **prevents the deposit of dirt and bacteria**, facilitating the cleaning

-  **White gloss finish** with a **porcelain effect** that does not yellow

-  **Immediate application** in the self-adhesive version





Profiles for hardware/diy



-  **Lightweight, handy** to transport

-  **Variety of cross-sections** for do-it-yourself projects

-  **Easy to drill, cut, weld and paint**

-  Exclusive colour ranges: **we are the only one to offer glossy finish PVC and mat black aluminium**

-  **Color fixed by anodic bath** that does not deteriorate



clients / **project**
the character is recognized by its profile



34

countries with partner distributors

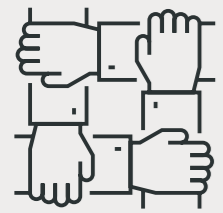

110

agents for the sales network (Italian and foreign market)



AN INTERNATIONAL NETWORK

Not only Italy: we are present on the international market with distribution centers in South America, France and Belgium. By means of a capillary network of agents and merchandisers we constantly support each of our customer, anywhere in the world.

To choose us means to start a path of shared growth. We **work together** with our customers to understand which products and display units suit best to their business and the most effective approach to get the **best performance on the market together with high profitability.**

We care and want to solve the multiple needs of our customers. Each one represents a unique and exclusive reality. We dedicate them our constant attention and care for the details. We support them with passion and continuity, establishing one **real partnership to guarantee medium and long-term results.**



I design every day functional solutions targeted for each customer. My sales manual? **listen** and relate myself with each one of them, to **understand specific needs and targets.**

Lorenzo Tinti, marketing department

● **Arcansas locations Italy / Europe**

ITALY (Piagge) | headquarters (production, stock, logistics)

ITALY (Mondavio) | branch 1 (production)

FRANCE (Diemoz) | warehouse and sales office 1

SPAIN (Barcelona) | sales office 2

GERMANY (Dresden) | sales office 3

UNITED KINGDOM (Bedford) | sales office 4

POLAND (Wroclaw) | sales office 5

● **Arcansas agents in Europe and worldwide**

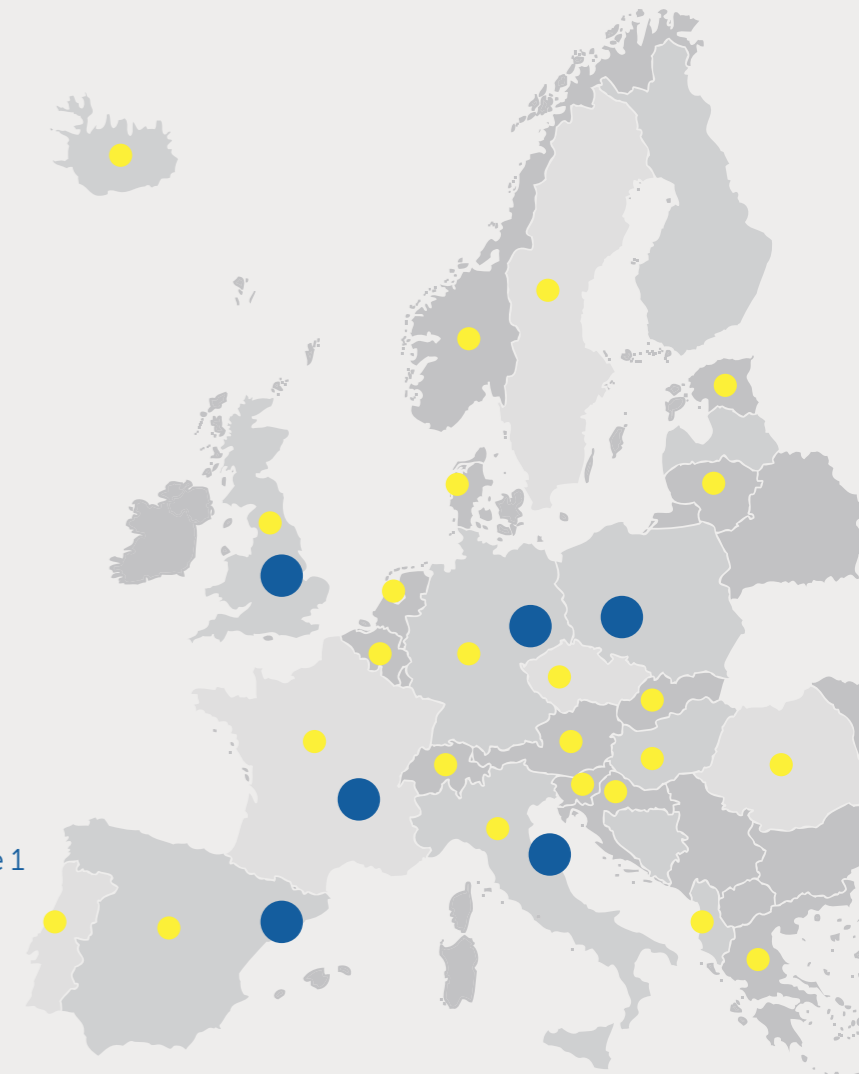

We organise **training courses for sales people and sector heads**, in co-operation with important partners in the large retail chains. The courses develop

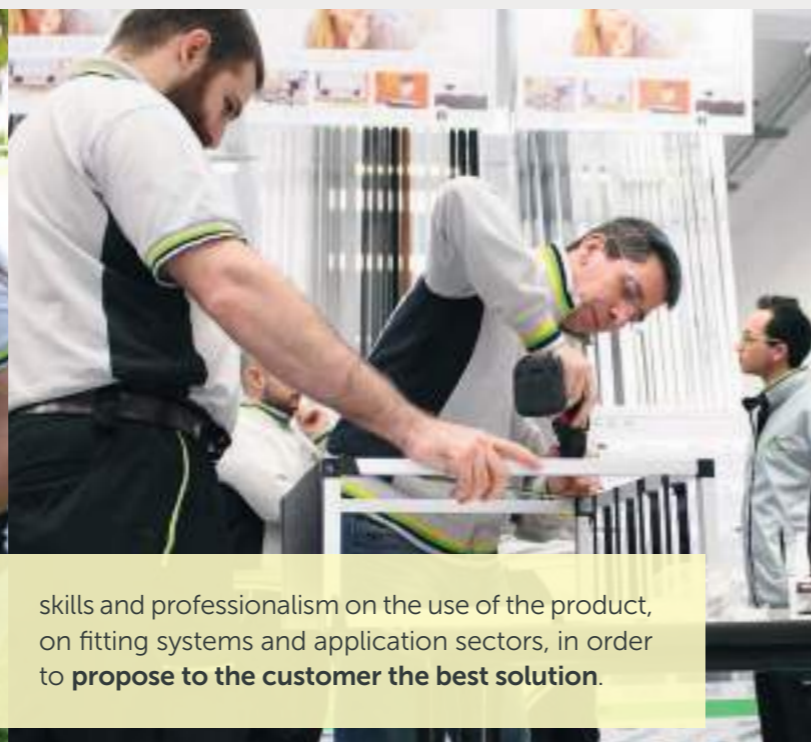

skills and professionalism on the use of the product, on fitting systems and application sectors, in order to **propose to the customer the best solution.**

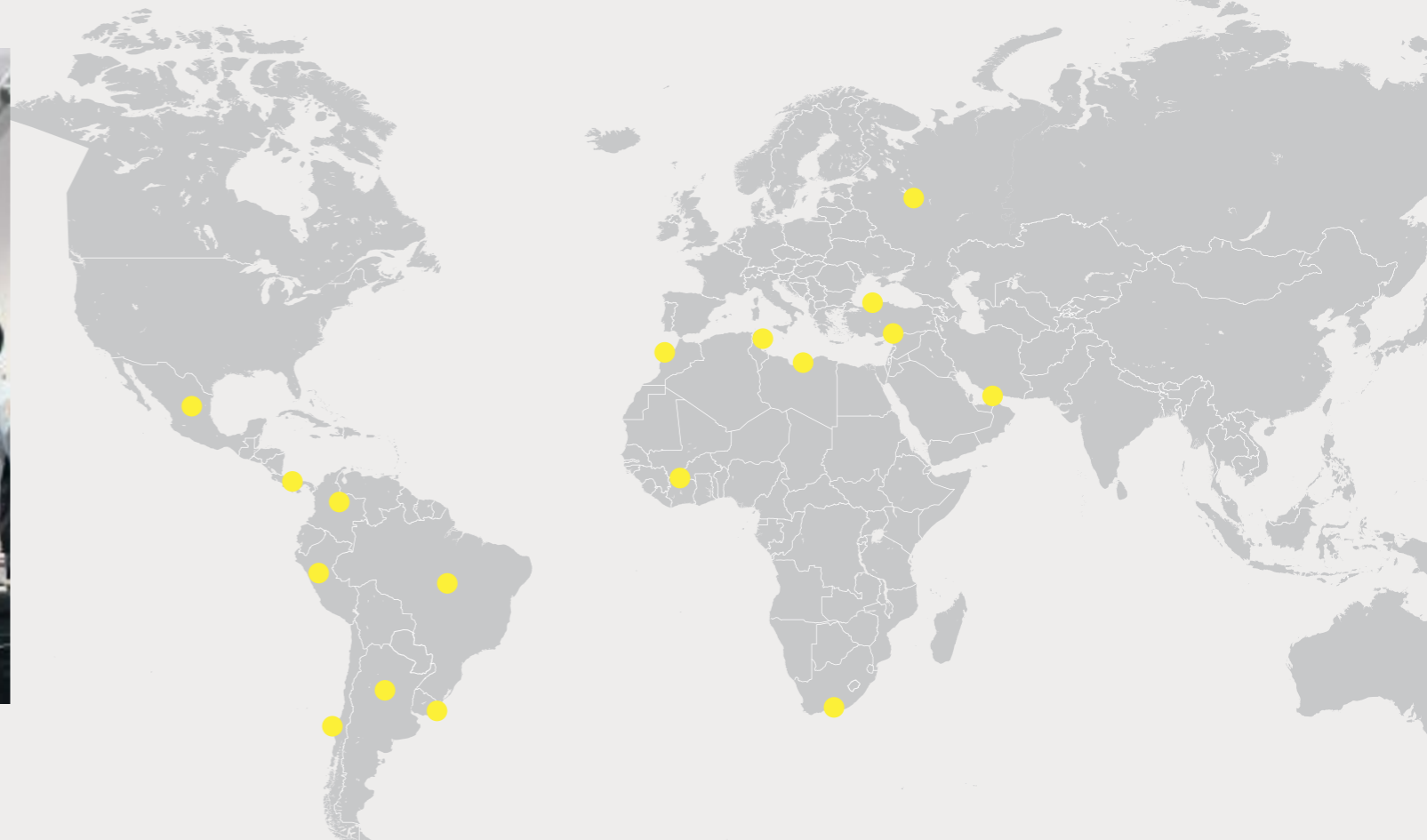

ICONE PERSONALIZZATE
CUSTOMIZED LABELS



Fliesenprofile
6mm Profile Für Fliesenstärke 4-5mm
8mm Profile Für Fliesenstärke 6-7mm



Fliesenprofile
10mm Profile Für Fliesenstärke 8-9mm



DIDATTICA SU ESPOSITORE
DISPLAY POS





Soluzioni espositive
Displays
Présentoirs
Expositores

EDDY cod. 3017/9003



LIVELLO 1 LEVEL 1	Larghezza	Altezza min. soffitto Min. height	Profondità pcs -	Capienza max. Max pcs
BARRE LUNGHE LONG LENGTHS	0,56 m	H. 3,00 m	0,47 m	12

	Larghezza width	Profondità Depth
MISURE GANCIO HOOK SIZES	5 cm	12 cm

EDDYBIG cod. 3018/9003 - 3018C/9003 - 3018B/9003



LIVELLO 1 LEVEL 1	Larghezza	Altezza min. soffitto Min. height	Profondità pcs -	Capienza max. Max pcs
BARRE LUNGHE LONG LENGTHS	0,95 - 1,20 - 1,30 m	H. 3,00 m	0,47 m	22 - 30 - 33

	Larghezza width	Profondità Depth
MISURE GANCIO HOOK SIZES	5 cm	12 cm

EDDY BLISTER cod. 3003AL/9003/PANN



LIVELLO 1 LEVEL 1	Larghezza	Altezza min. soffitto Min. height	Profondità pcs -	Capienza max. Max pcs
BARRE CORTE SHORT LENGTHS	0,56 m	H. 2,80 m	0,47 m	20

	Larghezza width	Profondità Depth
MISURE GANCIO HOOK SIZES	5 cm	12 cm

EDDYBIG BLISTER cod. 3018A/9003



LIVELLO 1 LEVEL 1	Larghezza	Altezza min. soffitto Min. height	Profondità pcs -	Capienza max. Max pcs
BARRE LUNGHE LONG LENGTHS	0,95 m	H. 2,80 m	0,47 m	12
LEVEL 2				Max items
BARRE CORTE SHORT LENGTHS	0,95 m	H. 2,80 m	0,47 m	12

	Larghezza width	Profondità Depth
MISURE GANCIO HOOK SIZES	3 cm	15 cm

3 LIVELLI SUOLO (per soffitto basso) cod. 3020/9003 - 3022/9003



LEVEL 1	width	Min. roof height	Depth	Max items
BARRE LUNGHE LONG LENGTHS	0,56 - 0,95 m	H. 3,90 m	0,55 m	12 - 24
LEVEL 2				Max items
BARRE CORTE SHORT LENGTHS				12 - 24
LEVEL 3				Max items
BARRE CORTE SHORT LENGTHS				12 - 24

CASSETTI QUICKTECH (su richiesta)
QUICKTECH BOXES (on request)
cod. 3014/9003

REFERENZE CONTENUTE ITEMS CONTAINED	
Connessioni o antisdrucciolo Connections or no-slipery tape	6

3 LIVELLI SUOLO cod. 3021/9003 - 3019/9003



LEVEL 1	width	Min. roof height	Depth	Max items
BARRE LUNGHE O CORTE LONG OR SHORT LENGTHS	0,56 - 0,95 m	H. 4,10 m	0,55 m	12 - 24
LEVEL 2				Max items
BARRE CORTE SHORT LENGTHS				12 - 24
LEVEL 3				Max items
BARRE CORTE SHORT LENGTHS				12 - 24

CASSETTI QUICKTECH (su richiesta)
QUICKTECH BOXES (on request)
cod. 3014/9003

REFERENZE CONTENUTE ITEMS CONTAINED	
Connessioni o antisdrucciolo Connections or no-slipery tape	6

display units /

profit

the character is recognized by its profile

We create **extremely modular and customized display units** for every need, thanks to our thirty years experience in the retail management sector.

Our display units guarantee **high sales performances**, maximizing the profitability of the spaces. Their original and extremely communicative design has very direct objectives: to encourage the customer to stop, inform him and create a product culture, simplify and **make easy the buying process**.



+30%

sales increase

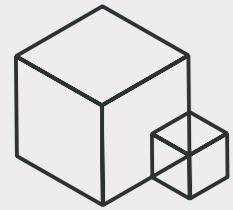

+25%

increase in profitability per linear meter



+20%
increased visibility with dedicated graphics



HIGH PROFITABLE SPACE

Through a dedicated software, we study the **minimum job quantity**, ideal to guarantee the **maximum display capacity** and **ease of extraction of the product**



INFOGRAPHIC AND VIDEO TUTORIAL

to **support the un-assisted sales** with instructions and **suggestions for product use**



GRAPHICS AND DEDICATED COMMUNICATION

for an **increase of visibility** up to 20%



HIGH QUALITY CERTIFIED MATERIALS

maximum guaranteed load of 300 kg for each display level and **ease of assembly**



POCKETS FOR METAL SHEETS

our display units are the only ones to have **pockets for metal sheets included** in the structure



CONTINUOUS SUPPORT

so that the system always works to the best of its ability (remodeling), according to market trends



logistics / **promptness**

the character is recognized by its profile

Our customers can dedicate themselves only to the important phases of their business: we take care of logistics. **We're the only contact** from transport to storage, to distribution.

We have technologically advanced systems for the management and monitoring of the activities related to distribution, storage and transport. Specific softwares plan accurately the routes and stretch, to ensure the **maximum precision and punctuality in the distribution of the goods.**



100%

total traceability for each order up to the client



48h

average time for order execution in Italy

logistics /

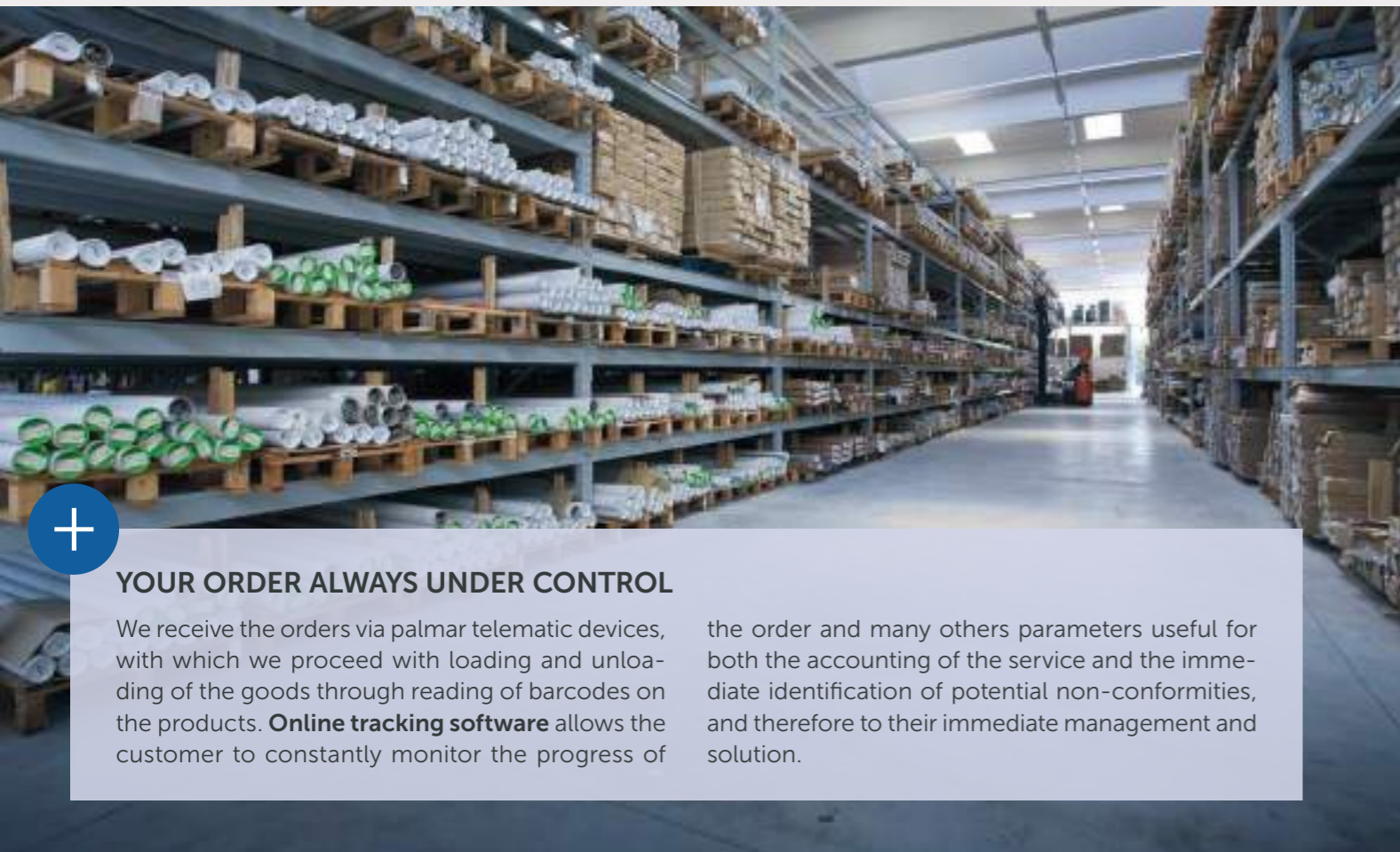
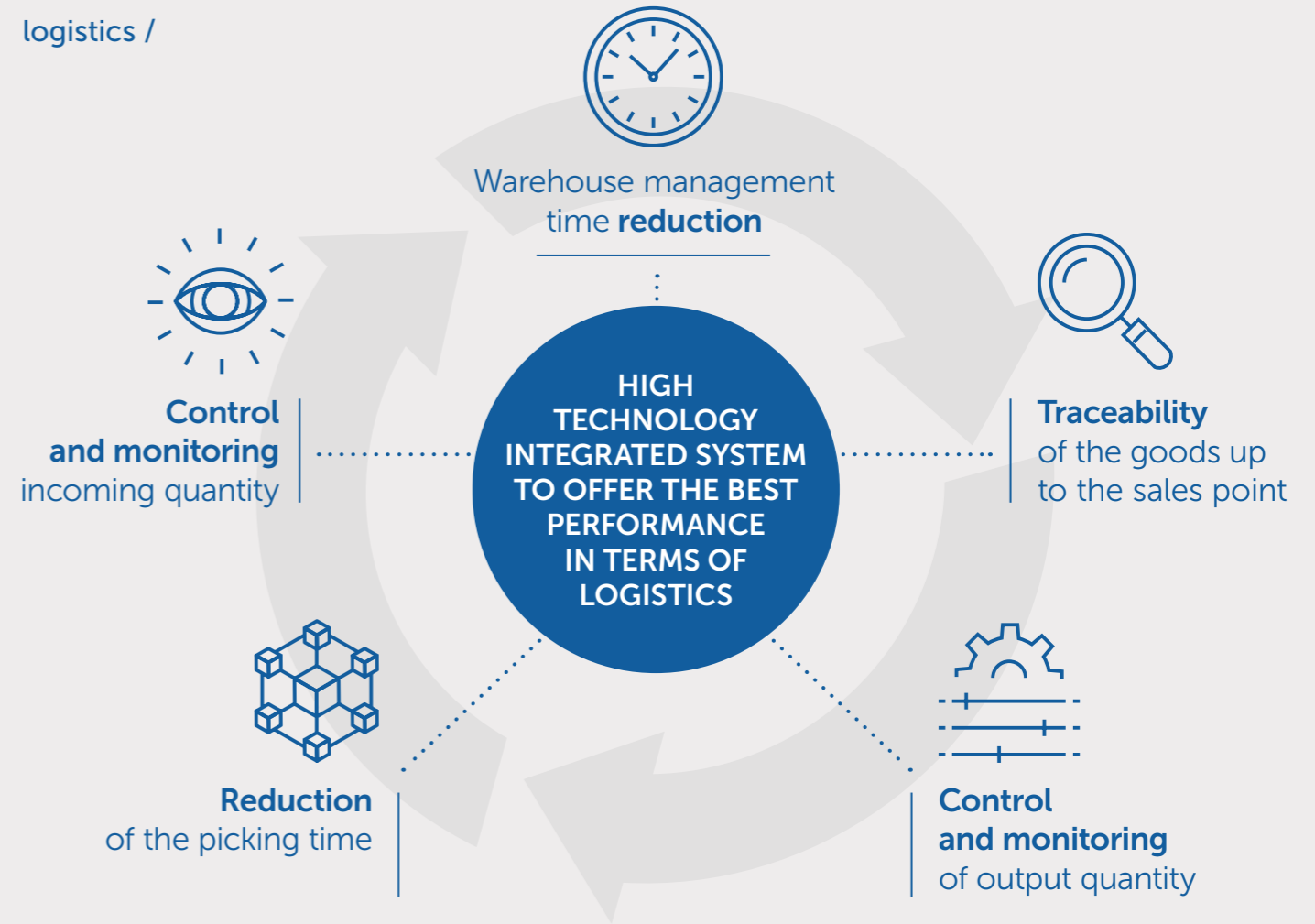

YOUR ORDER ALWAYS UNDER CONTROL

We receive the orders via palmar telematic devices, with which we proceed with loading and unloading of the goods through reading of barcodes on the products. **Online tracking software** allows the customer to constantly monitor the progress of

the order and many others parameters useful for both the accounting of the service and the immediate identification of potential non-conformities, and therefore to their immediate management and solution.



packaging / **pro**tection

the character is recognized by its profile

Choose the solution that best fits your needs. We offer our customers a range of **packaging solutions made purposely for every need:** carton pallets, carton boxes, customized pallets, tubes.

We make your orders special: we do not just think about the delivery, but also about the organisation inside the pallet, placing the materials in a safe way and identifying them with appropriate labels.

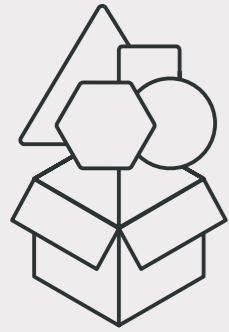

10

types of dedicated different packagings

packaging /



WORLDWIDE IN COMPLETE SECURITY

With our packagings and packages, it is possible to make shipments all over the world in total safety, keeping intact the quality of the goods transported.

The occupied space is optimized to a minimum: our packagings, in fact, can be overlapped thanks to the internal steel brackets.



Cod.	Cod. EAN	Page
052B2	8013237006105	23
003D	8013237001957	81
003D1	8013237001964	81
003D2	8013237028473	81
003D5	8013237057787	81
003D6	8013237057794	81
003D8	8013237057800	81
003E	8013237000356	81
003E6	8013237003562	81
003F	8013237000387	83
003F1	8013237002046	83
003F2	8013237002053	83
003F3	8013237003630	85
003F4	8013237003647	85
003F5	8013237002084	85
003F7	8013237003678	85
003F8	8013237002114	85
003G	8013237000370	83
003G1	8013237003715	83
003G2	8013237003722	83
003L	8013237002367	45
003M	8013237003111	45
003N	8013237025571	45
004	8013237002442	43
004C	8013237002466	43
005	8013237000059	43
005A	8013237000516	43
005B	8013237000523	43
006	8013237000066	43
006A	8013237000615	39
006A1	8013237002596	39
006A10	8013237057749	39
006A11	8013237057756	39
006A12	8013237057763	39
006A13	8013237057770	39
006A14	8013237060725	39
006A3	8013237006136	39
006A5	8013237002633	39
006A6	8013237057701	39
006A7	8013237057718	39
006A8	8013237057725	39
006A9	8013237057732	39
006B	8013237002640	39
006C	8013237000639	39
006C/GA	8013237145231	39
006H	8013237000684	41
006H1	8013237002763	41
006H2	8013237057473	41
006H3	8013237057480	41
006K	8013237006112	41
006K1	8013237006211	41
006K2	8013237061128	41
006K3	8013237057497	41
006K4	8013237057503	41
006K5	8013237057510	41
006K6	8013237057527	41
006K7	8013237057534	41
007A	8013237000714	79
007B	8013237000721	79
007C	8013237000738	79
009A1	8013237009113	79
009A2	8013237009120	79
009A3	8013237009137	79
009F7	8013237009670	71
009F8	8013237009687	71
009F9	8013237003098	71
009G3	8013237009731	67
009G3B	8013237003135	67
009G7	8013237003173	67

009G7B	8013237097721	67
009M1/70	8013237003241	131
009M2/70	8013237003258	131
009M22/70	8013237074821	131
009M3/70	8013237003296	131
009M5/70	8013237040031	131
009M6/70	8013237003302	131
009M6A/70	8013237060350	131
009M7/70	8013237003326	131
009M8/73	8013237133986	131
015	8013237000158	25
015A	8013237003494	25
016	8013237000165	25
016A	8013237001612	25
017	8013237003586	25
017B	8013237003609	25
017D	8013237001742	25
017D/GA	8013237145293	25
018	8013237000189	25
018A	8013237001810	25
018A/GA	8013237145286	25
019	8013237003746	25
019A	8013237001919	25
019C	8013237001933	25
020	8013237000202	25
020A	8013237002015	25
020A/GA	8013237145248	25
023C/63	8013237073282	55
023C/90	8013237003890	51
023C/91	8013237003906	51
023C/92	8013237003913	51
023C/96	8013237073268	55
023C/99S	8013237073275	55
023C1/63	8013237081461	55
023C1/90	8013237060732	51
023C1/93	8013237081416	53
023C1/96	8013237081454	55
023C1/99S	8013237081478	55
023D/63	8013237070878	55
023D/90	8013237234904	51
023D/91	8013237002329	51
023D/92	8013237002398	51
023D/96	8013237070854	55
023D/99S	8013237070861	55
023E/93	8013237026530	53
023E/94	8013237026547	53
023F/93	8013237223939	53
023F/94	8013237223946	53
024/90	8013237025564	51
024/91	8013237025557	51
024/92	8013237025540	51
024/93	8013237142223	53
024A/100	8013237150846	57
024A/101	8013237150853	57
024A/102	8013237150860	57
024A/103	8013237150884	57
024A/104	8013237150891	57
024A/105	8013237150877	57
024A/121	8013237054250	59
024A/127	8013237054267	59
024A/130	8013237054274	59
024A/63	8013237072292	55
024A/90	8013237003968	51
024A/91	8013237003975	51
024A/92	8013237003982	51
024A/96	8013237072209	55
024A/99S	8013237073138	55
024A1/121	8013237055363	59
024A1/127	8013237055370	59
024A1/130	8013237055387	59
024A1/63	8013237081430	55
024A1/90	8013237058210	51

024A1/96	8013237081423	55
024A1/99S	8013237081447	55
024A2/121	8013237059538	59
024A2/127	8013237059545	59
024A2/130	8013237059552	59
024A3/90	8013237059606	51
024A4	8013237134181	51
024A4/90	8013237059729	51
024A5	8013237134198	51
024A5/90	8013237059736	51
024A6/90	8013237059774	51
024B/100	8013237149185	57
024B/101	8013237149192	57
024B/102	8013237149208	57
024B/103	8013237149215	57
024B/104	8013237149222	57
024B/105	8013237149239	57
024B/63	8013237070847	55
024B/90	8013237002428	51
024B/91	8013237024215	51
024B/92	8013237024222	51
024B/96	8013237070823	55
024B/99S	8013237070830	55
024B1A/121	8013237055356	59
024B1A/127	8013237055332	59
024B1A/130	8013237055349	59
024B2/121	8013237059637	59
024B2/127	8013237059613	59
024B2/130	8013237059620	59
024B3/121	8013237059781	59
024B3/127	8013237059798	59
024B3/130	8013237059804	59
024B4/121	8013237059811	59
024B4/127	8013237059828	59
024B4/130	8013237059835	59
024B5/123	8013237134150	185
024C/93	8013237025854	53
024C/94	8013237025861	53
024C1/93	8013237054298	53
024D/93	8013237024437	53
024D/94	8013237024444	53
024D2/90	8013237134204	183
024D3/90	8013237134228	183
024D3/91	8013237134273	183
025A/83	8013237042363	221
025A/84	8013237042356	221
025A/85	8013237042332	221
025A/87	8013237042349	221
025G3/90	8013237056421	153
025GA/90	8013237042707	153
025GA1/90	8013237054366	153
025GA2/90	8013237054861	151
025GA3/90	8013237060138	151
025GA4/90	8013237060145	151
025GA5/90	8013237060152	151
025GA6/90	8013237060169	151
025H1/90	8013237045074	161
025H3/90	8013237056438	163
025HA/90	8013237047221	163
025HA1/90	8013237054335	163
025HA2/90	8013237054823	161
025L1/90	8013237056384	163
025LA/90	8013237047238	163
025LA1/90	8013237054359	163
026A	8013237025830	181
026A1	8013237044923	181
026B	8013237025847	181
026B2	8013237054380	181
026B3	8013237054779	181
026C	8013237056759	181
027/120	8013237043292	153
027/121	8013237043308	153

027/122	8013237043315	151
027/123	8013237043322	153
027/124	8013237043339	151
027/125	8013237047597	153
027/126	8013237047603	153
027/127	8013237047610	155
027/128	8013237047627	155
027/129	8013237047634	155
027/130	8013237047641	155
027/131	8013237047658	155
027/132	8013237047665	155
027/133	8013237047672	155
027/134	8013237047689	155
027/136	8013237049195	155
027/139	8013237049225	155
027/143	8013237138233	155
027/144	8013237138240	157
027/145	8013237146085	157
027/146	8013237146092	157
027/147	8013237146108	157
027/148	8013237146115	157
027/149	8013237146122	157
027/150	8013237146139	157
027/152	8013237146146	157
027/153	8013237146153	157
027/154	8013237146597	157
027/155	8013237146603	157
027/157	8013237146627	157
027A/120	8013237043353	163
027A/121	8013237043360	163
027A/122	8013237043377	163
027A/123	8013237043384	163
027A/124	8013237043391	165
027A/125	8013237047696	165
027A/126	8013237047702	165
027A/127	8013237047719	165
027A/128	8013237047726	165
027A/129	8013237047733	167
027A/130	8013237047740	167
027A/131	8013237047757	167
027A/132	8013237047764	167
027A/133	8013237047771	167
027A/134	8013237047788	167
027A/136	8013237049249	167
027A/139	8013237049270	167
027A/143	8013237138257	167
027A/144	8013237138264	169
027A/145	8013237146160	169
027A/146	8013237146177	169
027A/147	8013237146184	169
027A/148	8013237146191	169
027A/149	8013237146207	169
027A/150	8013237146214	169
027A/152	8013237146221	169
027A/153	8013237146238	169
027A/154	8013237146689	169
027A/155	8013237146696	169
027A/157	8013237146719	169
027A6/121	8013237060695	163
027A6/123	8013237063191	163
027A6/125	8013237077495	165
027A6/130	8013237077501	167
027A6/133	8013237077518	167
027A6/136	8013237077525	167
027A6/144	8013237146405	169
027A6/145	8013237146320	169
027A6/146	8013237146337	169
027A6/147	8013237146344	169
027A6/148	8013237146351	169
027A6/149	8013237146368	169
027A6/150	8013237146375	169
027A6/152	8013237146382	169

027A6/153	8013237146399	169
027A6/154	8013237149130	169
027A6/155	8013237149147	169
027A6/157	8013237149154	169
027AX/90	8013237048617	163
027AX/91	8013237048624	163
027AX1/90	8013237053871	163
027B/120	8013237047818	163
027B/121	8013237047825	163
027B/122	8013237047832	163
027B/123	8013237047849	163
027B/124	8013237047856	165
027B/125	8013237047863	165
027B/126	8013237047870	165
027B/127	8013237047887	165
027B/128	8013237047894	165
027B/129	8013237047900	167
027B/130	8013237047917	167
027B/131	8013237047924	167
027B/132	8013237047931	167
027B/133	8013237047948	167
027B/134	8013237047955	167
027B/139	8013237049324	167
027B2/121	8013237060022	161
027B2/123	8013237060015	161
027B3/121	8013237060046	161
027B3/123	8013237060039	161
027B4/121	8013237060053	161
027B4/123	8013237060060	161
027B5/121	8013237060077	161
027B5/123	8013237060084	161
027BX/90	8013237048648	163
027BX/91	8013237048655	163
027BX1/90	8013237054342	163
027C/120	8013237047962	173
027C/121	8013237047979	173
027C/122	8013237047986	173
027C/123	8013237047993	173
027C/124	8013237048006	173
027C/125	8013237048013	173
027C/126	8013237048020	173
027C/127	8013237048037	173
027C/128	8013237048044	173
027C/129	8013237048051	173
027C/130	8013237048068	173
027C/131	8013237048075	175
027C/132	8013237048082	175
027C/133	8013237048099	175
027C/134	8013237048105	175
027C/136	8013237052225	175
027C/139	8013237054205	175
027C/143	8013237138271	175
027C1/90	8013237056391	173
027CB/121	8013237078447	171
027CB/123	8013237078454	171
027CB/127	8013237078461	171
027CB/129	8013237131876	171
027CB/130	8013237131869	171
027CB/131	8013237078478	175
027CB/132	8013237133412	175
027CX/90	8013237048679	173
027CX/91	8013237048686	173
027CX/92	8013237048693	173
027CX1/90	8013237054328	173
027CX2/90	8013237054809	171
027D/120	8013237048112	177
027D/121	8013237048129	177
027D/122	8013237048136	177
027D/123	8013237048143	177
027D/124	8013237048150	177
027D/125	8013237048167	179
027D/126	8013237048174	179

027D/127	8013237048181	179
027D/128	8013237048198	179
027D/129	8013237048204	179
027D/130	8013237048211	179
027D/131	8013237048228	179
027D/132	8013237048235	179
027D/133	8013237048242	179
027D/134	8013237048259	179
027D/136	8013237054212	179
027D/139	8013237054229	179
027D/90	8013237141516	177
027DX/90	8013237048709	177
027DX/91	8013237048716	177
027DX/92	8013237048723	177
027DX1/90	8013237054373	177
027EX1/90	8013237135621	187
027EX1/91	8013237134280	187
027G/121	8013237059576	153
027G/123	8013237059569	153
027G1/121	8013237059651	151
027G1/123	8013237059644	151
027G2/121	8013237059668	151
027G2/123	8013237060114	151
027G3/121	8013237059842	151
027G3/123	8013237060121	151
027G6/121	8013237060688	151
027G6/123	8013237063115	151
027G6/125	8013237077532	153
027G6/130	8013237064235	155
027G6/133	8013237063184	155
027G6/136	8013237063160	155
027G6/144	8013237138189	157
027G6/145	8013237146245	157
027G6/146	8013237146252	157
027G6/147	8013237146269	157
027G6/148	8013237146276	157
027G6/149	8013237146283	157
027G6/150	8013237146290	157
027G6/152	8013237146306	157
027G6/153	8013237146313	157
027G6/154	8013237149109	157
027G6/155	8013237149116	157
027G6/157	8013237149123	157
027G8/90	8013237134792	183
027G8A/134	8013237134822	185
027G8A/136	8013237134839	185
027G8A/91	8013237134846	183
027G8B/90	8013237134907	183
027G9/90	8013237134808	183
027G9A/90	8013237134815	183
027H/121	8013237059583	161
027H/123	8013237059590	161
027H1/121	8013237059699	161
027H1/123	8013237059705	161
027H2/121	8013237059866	161
027H2/123	8013237059873	161
027H3/121	8013237059880	161
027H3/123	8013237059897	161
027X/90	8013237048587	153
027X/91	8013237048594	153
027X/92	8013237048600	153
027X1/90	8013237053826	153
028/121	8013237061791	153
028/123	8013237053857	153
028/127	8013237053840	151
028/128	8013237133962	155
028/131	8013237075828	151
028A/121	8013237061814	161
028A/123	8013237053895	161
028A/127	8013237053918	161
028A/128	8013237133979	165
028A/131	8013237078423	161

028G/90	8013237004149	89
028G/91	8013237004156	89
028G1/90	8013237004170	89
028G1/91	8013237004187	89
028H/90	8013237004231	89
028H/91	8013237002862	89
028H1/90	8013237028817	89
028H1/91	8013237028619	89
028H2/90	8013237028893	89
028H2/91	8013237028824	89
028H3/90	8013237028848	89
028H3/91	8013237028831	89
028H4/90	8013237056506	89
028H4/91	8013237056513	89
030/25	8013237134136	61
030/26	8013237134211	61
031/25	8013237134242	61
031/26	8013237134174	61
032K/90	8013237004484	87
032K/91	8013237004491	87
032K/92	8013237004507	87
032K1/90	8013237054304	87
032K2/90	8013237059934	87
032K3/90	8013237059989	87
032K4/90	8013237059996	87
032K5/90	8013237060008	87
032L/90	8013237032104	87
032L/91	8013237003289	87
032L/92	8013237532109	87
032M/90	8013237032135	87
032M/91	8013237032418	87
032M/92	8013237003210	87
032N/90	8013237004590	87
032N/91	8013237004606	87
032N/92	8013237004613	87
032P/90	8013237090005	87
032P/91	8013237090012	87
032P2/90	8013237062248	87
032P3/90	8013237134860	87
032R/90	8013237036539	87
032R/91	8013237036546	87
032R1/90	8013237134853	87
032S/90	8013237037802	87
032S/91	8013237037796	87
045A/90	8013237004941	129
045A/91	8013237024871	129
045A/92	8013237041762	129
045A1/90	8013237059941	129
045D/90	8013237005054	129
045D/91	8013237025137	129
045D/92	8013237041779	129
045D1/90	8013237052164	129
045D3/90	8013237060770	129
045E1/90	8013237071509	129
045E1/91	8013237071516	129
045E1/92	8013237041755	129
045G/90	8013237053482	129
045G/91	8013237053512	129
045G/92	8013237041793	129
045M	8013237035419	125
045M/90	8013237035426	125
045M2/90	8013237085391	125
045M3/90	8013237133696	125
045N	8013237048792	123
045N/90	8013237048808	123
045N/92	8013237048822	123
045P	8013237048839	121
045P/90	8013237048846	121
045P/91	8013237048853	121
045P/92	8013237048860	121
045P1/90	8013237080631	121
045S/90	8013237053086	121

045T/90	8013237052331	121
045T2/90	8013237138462	121
046C10/100	8013237145378	201
046C10/101	8013237145385	201
046C10/102	8013237145392	201
046C10/103	8013237145408	201
046C10/104	8013237145415	201
046C10/105	8013237145422	201
046C10/90	8013237005405	197
046C11/100	8013237148775	213
046C11/101	8013237148782	203
046C11/103	8013237148805	207
046C11/104	8013237148812	209
046C11/105	8013237148829	211
046C11/90	8013237082123	199
046C12/100	8013237148713	213
046C12/101	8013237148720	203
046C12/103	8013237148744	207
046C12/104	8013237148751	209
046C12/105	8013237148768	211
046C12/90	8013237082130	199
046C13/90	8013237463137	127
046C13/91	8013237463410	127
046C13/92	8013237463427	127
046C14/100	8013237148843	213
046C14/100/2PZ	8013237150648	213
046C14/101	8013237148850	203
046C14/101/2PZ	8013237150662	203
046C14/103	8013237148874	207
046C14/103/2PZ	8013237150709	207
046C14/104	8013237148881	209
046C14/104/2PZ	8013237150723	209
046C14/105	8013237148898	211
046C14/105/2PZ	8013237150747	211
046C14/90	8013237148836	199
046C14/90/2PZ	8013237980696	199
046C17/90	8013237081034	127
046C18/100	8013237148911	213
046C18/101	8013237148928	203
046C18/103	8013237148942	207
046C18/104	8013237148959	209
046C18/105	8013237148966	211
046C18/90	8013237148904	199
046C19/100	8013237148980	213
046C19/101	8013237148997	203
046C19/103	8013237149017	207
046C19/104	8013237149024	209
046C19/105	8013237149031	211
046C19/90	8013237148973	199
046C5/90	8013237005481	127
046C5/91	8013237005498	127
046C51/90	8013237054311	127
046C5A/90	8013237005511	127
046C5A/91	8013237005528	127
046C5A/92	8013237005535	127
046C7/100	8013237145798	201
046C7/101	8013237145804	201
046C7/102	8013237145811	201

046M1/96	8013237081485	29
046M1/99S	8013237081508	29
046M2/90	8013237059712	27
046M3/90	8013237059743	27
046M4/90	8013237059750	27
046M5/90	8013237059767	27
046N/63	8013237070908	29
046N/90	8013237046149	27
046N/91	8013237046125	27
046N/92	8013237004682	27
046N/93	8013237077488	27
046N/96	8013237070885	29
046N/99S	8013237070892	29
046P/63	8013237073367	29
046P/90	8013237005658	27
046P/91	8013237005672	27
046P/92	8013237005689	27
046P/93	8013237145934	27
046P/96	8013237073350	29
046P/99S	8013237073381	29
046P1/90	8013237060749	27
046Q/63	8013237070939	29
046Q/90	8013237500498	27
046Q/91	8013237046811	27
046Q/92	8013237046194	27
046Q/96	8013237070915	29
046Q/99S	8013237070922	29
047	8013237005849	73
048	8013237000486	73
049	8013237000493	73
050	8013237005900	35
050A	8013237005917	35
051	8013237500511	35
051B	8013237005948	33
051B/SL	8013237062958	33
051B1	8013237049157	33
051B1/GA	8013237145224	33
051B10	8013237057664	33
051B11	8013237057671	33
051B12	8013237057688	33
051B13	8013237057695	33
051B14	8013237058227	33
051B15	8013237060718	33
051B1S	8013237138660	33
051B2	8013237048891	33
051B2/GA	8013237145217	33
051B4	8013237057022	33
051B5	8013237057046	33
051B6	8013237057626	33
051B7	8013237057633	33
051B8	8013237057640	33
051B9	8013237057657	33
051B5	8013237147150	33
051C	8013237005139	35
051D	8013237005962	23
051F	8013237005160	23
051G	8013237005986	23
051GA1	8013237138646	23
051L	8013237006013	31
051M	8013237053505	31
051NL	8013237051266	31
052	8013237500528	35
052A	8013237006037	23
052A1	8013237057541	23
052A2	8013237057558	23
052A3	8013237057565	23
052A4	8013237057572	23
052A5	8013237057589	23
052A6	8013237057596	23
052A7	8013237057602	23
052A8	8013237057619	23
052B	8013237052201	23

052B1	8013237052218	23
052B1/GA	8013237145309	23
052B11	8013237522117	23
052B11/GA	8013237145279	23
052B14	8013237081393	23
052B15	8013237081409	23
052B4	8013237052249	23
052B5	8013237006198	23
052B5A	8013237079376	23
052B8	8013237006266	23
052C	8013237006280	75
052C3	8013237029111	75
052C4	8013237029791	75
052D	8013237005245	75
052D1	8013237052416	75
052D1/GA	8013237145255	75
052D3	8013237057817	75
052D4	8013237057824	75
052D5	8013237057831	75
052D6	8013237057848	75
052E	8013237006341	23
052E1	8013237052515	23
052E2	8013237052522	23
052E4	8013237006396	65
052E4B	8013237052928	65
052E4B5B	8013237006402	65
052E5	8013237028992	65
052F3/430	8013237145620	77
052F3/430/G	8013237147112	77
052H/90	8013237148638	69
052L/90	8013237083816	69
052L1/90	8013237085384	69
052L2/90	8013237133702	69
052L3/90	8013237138486	69
053	8013237000530	111
053/2	8013237006525	111
053A	8013237006563	111
053AC	8013237006587	111
053B	8013237005320	111
053D	8013237026172	107
053D1	8013237028879	107
053D2	8013237053420	107
053D3	8013237029753	107
054	8013237000547	109
054A	8013237005412	109
054A3	8013237006662	109
054B	8013237006686	107
054B1	8013237041939	107
054B2	8013237042158	107
054D	8013237006693	109
057	8013237000578	119
057A	8013237006792	119
057H	8013237005795	119
058	8013237006976	113
062	8013237000622	113
063	8013237500634	95
063A/100	8013237149246	101
063A/101	8013237149253	101
063A/102	8013237149260	101
063A/103	8013237149277	101
063A/104	8013237149284	101
063A/105	8013237149291	101
063A1/93	8013237026165	99
063A10/93	8013237058630	99
063A2	8013237028800	95
063A2/90	8013237085124	99
063A2/93	8013237046675	99
063A3/93	8013237058609	99
063A4/63	8013237070960	99
063A4/93	8013237053499	99
063A4/96	8013237070946	99
063A4/99S	8013237070953	99

063A5/100	8013237150273	101
063A5/101	8013237150280	101
063A5/102	8013237150297	101
063A5/103	8013237150303	101
063A5/104	8013237150310	101
063A5/105	8013237150266	101
063A5/63	8013237072971	99
063A5/90	8013237036362	99
063A5/96	8013237072988	99
063A5/99S	8013237072995	99
063A51/90	8013237074401	99
063A6/90	8013237053475	99
063A8/93	8013237058616	99
063A9/93	8013237058623	99
063B	8013237009595	95
063B1	8013237071202	95
063C	8013237009601	95
063G/90	8013237090029	103
063G/91	8013237090036	103
063G3/90	8013237131685	103
063G5/90	8013237134020	103
063G6/90	8013237144111	105
063G6/93	8013237144128	105
063G7/90	8013237149178	105
063H	8013237053963	93
063H1	8013237055066	93
063H2	8013237057855	93
063H3	8013237057862	93
063H4	8013237057879	93
063H5	8013237057886	93
064	8013237000646	95
064A	8013237006419	97
064A2	8013237064129	95
064B	8013237009649	97
064C	8013237006433	97
064T/C	8013237134006	97
065	8013237009694	47
066	8013237000660	47
069	8013237000691	25
069B	8013237002923	25
069E	8013237006952	25
071	8013237011895	117
071E	8013237012236	117
071F	8013237007164	117
071L1	8013237133993	117
089	8013237000899	138
089A	8013237008918	138
089AS	8013237041878	138
089AS1	8013237041885	138
089S	8013237041854	138
089S1	8013237041861	138
090	8013237000905	138
091	8013237000912	138
092	8013237142988	138
092A	8013237142995	138
094	8013237143008	138
094A	8013237143015	138
095	8013237143022	138
095A	8013237143039	138
1083	8013237010836	133
1083/94	8013237510831	134
1103/93	8013237511036	135
137	8013237001377	132
137A	8013237013714	133
137AC	8013237043544	133
137B	8013237013721	133
137C	8013237013738	133
138	8013237014322	132
138A	8013237013813	133
138B	8013237013820	133
146	8013237014384	132
147	8013237014476	132

147A	8013237014483	132
147B	8013237029197	134
147B/C	8013237029531	135
148	8013237014490	132
148A	8013237014506	132
150	8013237014773	133
151	8013237014780	133
153	8013237014889	132
154	8013237014995	132
154B2/91	8013237154226	134
154B2/94	8013237154240	134
154B3/94	8013237036256	134
154B5/94	8013237154547	134
154B7/93	8013237031671	135
154B8/93	8013237029449	135
154B9/93	8013237031282	135
154D	8013237015114	133
154D/C	8013237031398	135
1700/01	8013237017002	215
1700/03	8013237170035	215
1700/04	8013237017057	215
1700/15	8013237017040	215
1700/40	8013237017026	215
1700/41	8013237170059	215
1700/42	8013237015893	215
1700/43	8013237031916	215
1701/01	8013237017019	215
1701/03	8013237017132	215
1701/04	8013237170141	215
1701/15	8013237017217	215
1701/40	8013237017200	215
1701/41	8013237017194	215
1701/42	8013237017149	215
1701/43	8013237031916	215
1702/01	8013237145941	189
1702/144	8013237146061	189
1702/145	8013237145965	189
1702/146	8013237145989	189
1702/147	8013237145972	189
1702/148	8013237145958	189
1702/149	8013237145996	189
1702/150	8013237146054	189
1702/152	8013237146016	195
1702/153	8013237146078	195
1702/154	8013237146009	195
1702/155	8013237146023	195
1702/156	8013237146030	195
1702/157	8013237146047	195
1706/03	8013237043964	217
1706/15	8013237043971	217
1706/80	8013237042370	217
1706/85	8013237801328	217
1706/86	8013237042387	217
1706/88	8013237042394	217
1707/03	8013237043988	217
1707/15	8013237043995	217
1707/80	8013237042875	217
1707/85	8013237042882	217
1707/86	8013237042899	217
1707/88	8013237042905	217
1708/03	8013237044008	219
1708/15	8013237044015	219
1708/80	8013237042912	219
1708/85	8013237042929	219
1708/86	8013237042936	219
1708/88	8013237042943	219
1709/03	8013237044022	219
1709/15	8013237044039	219
1709/80	8013237042950	219
1709/85	8013237042967	219
1709/86	8013237042974	219
1709/88	8013237042981	219

CODICE ARKANSAS/ PRODUCT CODE

1710/03	8013237044046	221
1710/15	8013237044053	221
1710/80	8013237042998	221
1710/85	8013237043001	221
1710/86	8013237043018	221
1710/88	8013237043025	221
259A	8013237019570	143
259A1	8013237019587	143
259A12	8013237066680	143
259B	8013237019600	143
259B1	8013237019617	143
259B12	8013237066697	143
259C	8013237019631	143
259C1	8013237019648	143
259D	8013237019662	143
259D1	8013237019686	143
259E	8013237071578	143
259F	8013237142018	143
259G	8013237071585	143
259L	8013237133436	143
260	8013237019709	147
260A	8013237019716	147
260D	8013237019761	147
260D3	8013237148522	147
260E	8013237019785	147
260L	8013237019815	147
260M	8013237019822	147
270A	8013237019891	145
270D	8013237019914	147
270D1	8013237019921	147
270D2	8013237980306	147
270F	8013237019945	147
270M	8013237019976	147
380C	8013237020484	145
380D	8013237003807	145
380E	8013237020545	145

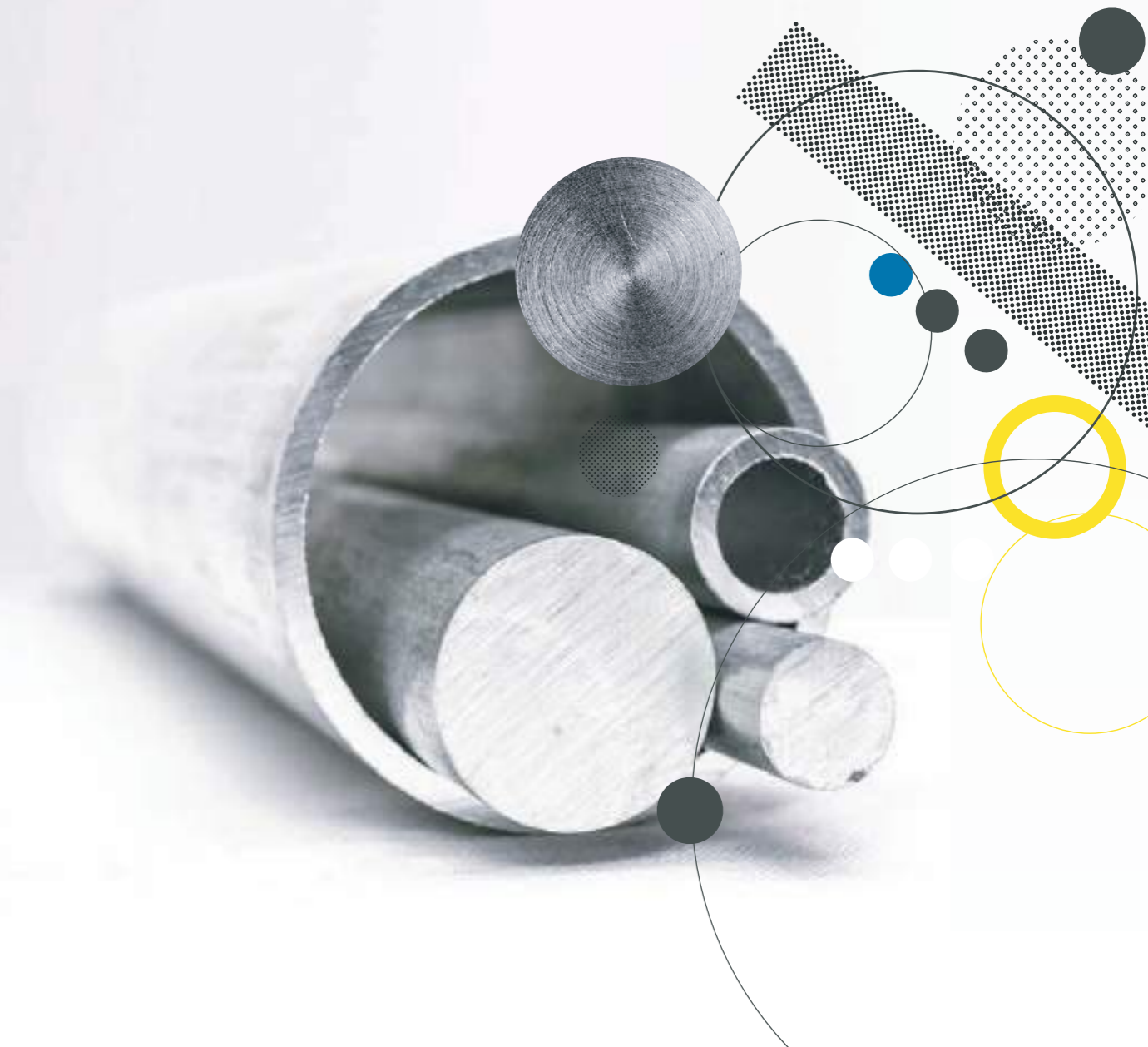

CONDIZIONI COMMERCIALI

Ordini, pagamenti e consegne:

1. Se non diversamente indicato, tutte le quantità sugli ordini vengono arrotondate alla quantità per convenzione del presente listino, altrimenti sarà applicato un incremento del prezzo di listino pari al 10%. La maggiorazione sarà del 20% nel caso in cui le quantità richieste siano inferiori a 10 pezzi. (Esempio di arrotondamento: da 11 a 14 arrotondamento a 10, da 15 a 19 arrotondamento a 20)
2. Pagamenti: prima fornitura, contrassegno.
3. Non saranno evase forniture con importi inferiori a €100,00 netto sconti.
4. Tutti gli ordini ricevuti entro le ore 11.00 verranno evasi entro le 24 ore.
5. Per consegne su appuntamento verificare con ufficio ordini fattibilità e sovrapprezzo.
6. Per spese di trasporto consultare l'ufficio commerciale di riferimento.

Spese varie:

1. Porto Franco per importi fattura superiori a € 250,00.
 2. Per importi Fattura inferiori a € 250,00 verranno addebitati € 15,00 per spese amministrative.
- Rischi nel trasporto: La merce viaggia a rischio e pericolo dell'acquirente, anche se in porto Franco.

CONDIZIONI GENERALI

Disegni e documenti descrittivi:

Tutte le Fotografie, i disegni e i dati tecnici dei prodotti a catalogo hanno carattere informativo ed esemplificativo, quindi non impegnativo.

Modifiche:

Arcansas Profili s.r.l si riserva il diritto di apportare modifiche ai propri prodotti, imballi e quant'altro senza obbligo di preavviso.

Reclami:

I reclami per vizi o difetti apparenti (es. mancanza o danneggiamento) vanno presentati al corriere direttamente all'atto del ricevimento della merce e tempestivamente anche ad Arcansas Profili s.r.l, a mezzo riserva scritta sulla bolla di consegna specificando il tipo di anomalia, pena la decadenza di qualunque diritto di garanzia e del diritto di risarcimento. I reclami per vizi o difetti non individuabili con un diligente controllo al momento del ricevimento della merce (vizi o difetti occulti), dovranno essere notificati, a pena di decadenza, ad Arcansas Profili s.r.l mediante lettera raccomandata A.R. entro sette giorni dalla scoperta del vizio o difetto e comunque non oltre 12 mesi dalla consegna. Eventuali reclami non daranno diritto all'acquirente di sospendere o ritardare i pagamenti dovuti ad Arcansas Profili s.r.l.

Garanzia e vizi:

Arcansas Profili s.r.l si impegna a sostituire i prodotti che presentino vizi, mancanza di qualità o difetti di conformità ad essa imputabili, verificatisi entro dodici mesi dalla consegna dei prodotti, purché gli stessi siano stati presentati tempestivamente nelle modalità precedentemente riportate. Arcansas Profili s.r.l. non garantisce la rispondenza dei prodotti a particolari specifiche o caratteristiche tecniche o la loro idoneità ad usi e/o utilizzi particolari, se non nella misura in cui tali caratteristiche siano state espressamente convenute nel contratto. In caso di vizi apparenti e/o occulti riconosciuti da Arcansas Profili s.r.l., l'acquirente ha diritto esclusivamente alla sostituzione del prodotto, che verrà accettato in reso solo in confezioni originali, integre e complete. Nessun prodotto potrà essere sostituito senza una preliminare autorizzazione scritta di Arcansas Profili s.r.l. La presente garanzia è sostitutiva delle garanzie e responsabilità previste per legge ed esclude ogni altra responsabilità di Arcansas Profili s.r.l comunque originata dai prodotti venduti, salvo il caso di dolo e colpa grave.

Riserva di proprietà:

I prodotti rimangono di proprietà di Arcansas Profili s.r.l sino al loro completo pagamento da parte dell'acquirente. Il mancato pagamento, anche parziale, dà diritto ad Arcansas Profili s.r.l di recuperare la merce oggetto di fornitura, anche se in deposito presso terzi.

Proprietà industriale e intellettuale:

Segni distintivi, fotografie di prodotti e/o tecnologie produttive e commerciali di Arcansas Profili s.r.l, non dovranno essere utilizzati o divulgati senza la previa autorizzazione scritta di Arcansas Profili s.r.l.

Privacy:

I dati personali anagrafici e fiscali acquisiti direttamente e/o tramite terzi da Arcansas Profili s.r.l (Località Cerbara, 61030 Terre Roveresche PU), titolare del trattamento, vengono utilizzati per esigenze contrattuali e di legge, nonché per consentire un'efficace gestione dei rapporti commerciali. Tali dati potranno essere comunicati in Italia e/o all'estero alla rete di agenti Arcansas Profili s.r.l, società di factoring, istituti di credito, società di recupero crediti, società di assicurazione del credito, società di informazioni commerciali, professionisti e consulenti, trasportatori.

Foro competente:

Per eventuali controversie derivanti dalle condizioni commerciali e/o dagli ordini ad essa connessi, sarà esclusivamente competente il tribunale di Pesaro.

BUSINESS TERMS

1. Unless otherwise stated, all order quantities are rounded to the quantity conventionally used in this price list; otherwise, an increase of 10% will be applied on the list prices. The supplement will be of 20% if the quantities requested are below than 10 pcs. (Rounding example: from 11 to 15 rounded down to 10, from 15 to 19 rounded up to 20)
2. For deliveries by appointment, check with the order office the possibility and surcharge.
3. For transport costs, consult the reference sales office.

GENERAL CONDITIONS

Designs and descriptive documents:

All the Photographs, designs, and technical data of the products in the catalogue are informative and illustrative, and so therefore not binding.

Modifications:

Arcansas Profili s.r.l reserves the right to make changes to its own products, packaging, and anything else without notice.

Complaints:

Claims for apparent defects (e.g. missing parts or damage) must be presented to the courier directly upon receipt of the goods and also promptly to Arcansas Profili s.r.l, by means of a written reservation on the delivery note specifying the type of anomaly, under penalty of forfeiture of any warranty claims and compensation claims.

Claims for defects that cannot be identified with a thorough check upon receipt of the goods (hidden defects) must be notified, under penalty of forfeiture, to Arcansas Profili s.r.l by registered letter with return receipt within seven days from the discovery of the defect and no later than 12 months from delivery.

Any complaints will not entitle the purchaser to suspend or delay payments due to Arcansas Profili s.r.l.

Warranty and defects:

Arcansas Profili s.r.l undertakes to replace products that present defects, lack of quality or lack of conformity attributable to it, which occurred within twelve months of delivery of the products, provided they have been promptly presented in the manner previously reported. Arcansas Profili s.r.l does not guarantee the compliance of the products with particular specifications or technical characteristics or their suitability for particular uses, except to the extent that these characteristics have been expressly agreed in the contract.

In the event of apparent and/or hidden defects recognised by Arcansas Profili s.r.l, the purchaser is only entitled to the replacement of the product, which will be accepted as a return only in original, intact, and complete packaging.

No product may be replaced without prior written authorisation from Arcansas Profili s.r.l.

This warranty replaces the warranties and responsibilities provided for by law and excludes any other liability of Arcansas Profili s.r.l originating from the products sold, except in cases of willful misconduct and gross negligence.

Retention of title:

The products remain the property of Arcansas Profili s.r.l until their full payment by the purchaser. Failure to pay, even partial, entitles Arcansas Profili s.r.l to recover the delivered goods, even if they are on deposit with third parties.

Industrial and intellectual property:

Distinctive signs, photographs of Arcansas Profili s.r.l products and/or production and business technologies must not be used or disclosed without the prior written permission of Arcansas Profili s.r.l.

Privacy:

The personal and tax data acquired directly and/or through third parties from Arcansas Profili s.r.l (Località Cerbara, 61030 Terre Roveresche PU), the data controller, are used for contractual and legal requirements, as well as to allow effective management of business relationships.

Such data may be communicated in Italy and/or abroad to the network of Arcansas Profili s.r.l agents, factoring companies, credit institutions, debt collection companies, credit insurance companies, business information companies, professionals and consultants, transporters.

Jurisdiction:

For any disputes arising from the business conditions and/or from the orders connected to it, the Pesaro court will have exclusive jurisdiction.

CONDITIONS COMMERCIALES

1. Sauf indication contraire, toutes les quantités commandées sont arrondies à la quantité conventionnellement utilisée dans cette liste de prix; sinon, une augmentation de 10% sera appliquée sur les prix catalogue. Le supplément sera de 20% si les quantités demandées sont inférieures à 10 pièces. (Exemple d'arrondi: de 11 à 15 arrondi à 10, de 15 à 19 arrondi à 20).
2. Pour les livraisons sur rendez-vous, vérifiez auprès du bureau des commandes la possibilité et surtaxe.
3. Pour les frais de transport, consultez le bureau de vente de référence.

CONDITIONS GÉNÉRALES

Dessins et documents descriptifs :
Toutes les photographies, dessins et données techniques des produits du catalogue sont à titre informatif et illustratif, donc non contraignants.

Modifications :

Arcansas Profili s.r.l se réserve le droit d'apporter des modifications à ses propres produits, emballages et toute autre chose sans préavis.

Réclamations :

Les réclamations pour vices ou défauts apparents (par exemple, manque ou dommage) doivent être présentées au transporteur directement à la réception de la marchandise et également dans les meilleurs délais à Arcansas Profili s.r.l, au moyen d'une réserve écrite sur le bon de livraison précisant le type d'anomalie, sous peine de déchéance de tout droit de garantie et de réparation. Les réclamations pour vices ou défauts qui ne peuvent être identifiés avec un contrôle diligent à la réception de la marchandise (vices ou défauts cachés) doivent être notifiées, sous peine de déchéance, à Arcansas Profili s.r.l par lettre recommandée avec accusé de réception dans les sept jours à compter de la découverte du vice ou du défaut, cependant, au plus tard 12 mois après la livraison. Toute réclamation ne donnera pas le droit à l'acheteur de suspendre ou de retarder les paiements dus à Arcansas Profili s.r.l.

Garantie et défauts :

Arcansas Profili s.r.l s'engage à remplacer les produits présentant des dommages, des défauts de qualité ou des défauts de conformité qui lui sont imputables, survenus dans les douze mois suivant la livraison des produits, à condition qu'ils aient été présentés dans les meilleurs délais de la manière précédemment signalée. Arcansas Profili s.r.l ne garantit pas la conformité des produits à des spécifications ou caractéristiques techniques particulières ou leur adéquation à des usages et/ou usages particuliers, sauf dans la mesure où ces caractéristiques ont été expressément convenues dans le contrat. Si des défauts apparents et/ou cachés sont décelés par Arcansas Profili s.r.l, l'acheteur n'a droit qu'au remplacement du produit, qui ne sera accepté en retour que dans son emballage d'origine, intact et complet. Aucun produit ne peut être remplacé sans l'autorisation écrite préalable d'Arcansas Profili s.r.l. Cette garantie remplace les garanties et responsabilités prévues par la loi et exclut toute autre responsabilité d'Arcansas Profili s.r.l provenant des produits vendus, sauf en cas de faute intentionnelle et de négligence grave.

Réserve de propriété :

Les produits restent la propriété d'Arcansas Profili s.r.l jusqu'à leur paiement intégral par l'acheteur. Le défaut de paiement, même partiel, autorise Arcansas Profili s.r.l à récupérer les marchandises livrées, même si elles sont en dépôt auprès de tiers.

Propriété industrielle et intellectuelle :

Les signes distinctifs, photographies des produits Arcansas Profili s.r.l et/ou technologies de production et commerciales ne doivent pas être utilisés ou divulgués sans l'autorisation écrite préalable d'Arcansas Profili s.r.l.

Confidentialité :

Les données personnelles et fiscales personnelles acquises directement et/ou par l'intermédiaire de tiers auprès d'Arcansas Profili s.r.l (Località Cerbara, 61030 Terre Roveresche PU), responsable du traitement, sont utilisées pour les exigences contractuelles et légales, ainsi que pour permettre une gestion efficace des relations commerciales. Ces données peuvent être communiquées en Italie et/ou à l'étranger au réseau d'agents Arcansas Profili s.r.l, aux sociétés d'affacturage, aux établissements de crédit, aux sociétés de recouvrement de créances, aux sociétés d'assurance-crédit, aux sociétés d'informations commerciales, aux professionnels et consultants, ainsi qu'aux transporteurs.

Tribunal compétent :

Pour tout litige découlant des conditions commerciales et/ou des commandes qui y sont liées, le tribunal de Pesaro sera seul compétent.

CONDICIONES COMERCIALES

1. Salvo que se indique lo contrario, todas las cantidades de pedido se ajustarán a la cantidad mínima de pedido indicada en este catálogo; de lo contrario, se aplicará un aumento del 10% a los precios de tarifa. El suplemento será del 20% si las cantidades solicitadas son inferiores a 10 unidades. (Ejemplo: de 11 a 15 se enviarán 10 unidades, de 15 a 19 se enviarán 20 unidades)
2. Para entregas con cita previa, consulte con el departamento de pedidos la posibilidad y eventual recargo.
3. Para los gastos de transporte, consulte con la oficina de ventas de referencia.

CONDICIONES GENERALES

Diseños y documentos descriptivos:
Todas las fotografías, diseños y datos técnicos de los productos del catálogo son informativos e ilustrativos, por lo que no son vinculantes.

Modificaciones:

Arcansas Profili s.r.l se reserva el derecho de hacer cambios a sus propios productos, embalajes y cualquier otro elemento sin previo aviso.

Reclamaciones:

Las reclamaciones por defectos o vicios aparentes (por ejemplo, falta o daños) deben presentarse al mensajero directamente al recibir la mercancía y sin demora a Arcansas Profili s.r.l mediante notificación escrita en el albarán de entrega especificando el tipo de anomalía, a cambio de la pérdida de todo derecho de garantía y de compensación. Las quejas por defectos o vicios no detectables con un control diligente al recibir la mercancía (defectos o vicios ocultos), deben notificarse, so pena de caducidad, a Arcansas Profili s.r.l por carta certificada con acuse de recibo en un plazo de siete días a partir del descubrimiento del defecto o vicio y, en cualquier caso, en un plazo máximo de 12 meses a partir de la entrega. Cualquier queja no dará derecho al comprador a suspender o retrasar los pagos debidos a Arcansas Profili s.r.l.

Garantía y defectos:

Arcansas Profili s.r.l se compromete a sustituir los productos que presenten defectos, falta de calidad o falta de conformidad que le sean imputables, que se hayan producido dentro de los doce meses siguientes a la entrega de los productos, siempre y cuando se hayan presentado sin demora en la forma anteriormente comunicada. Arcansas Profili s.r.l no garantiza la conformidad de los productos con especificaciones o características técnicas particulares o su idoneidad para usos y/o usos particulares, salvo en la medida en que dichas características hayan sido expresamente acordadas en el contrato. En caso de defectos aparentes y/u ocultos reconocidos por Arcansas Profili s.r.l, el comprador tiene el derecho exclusivo a la sustitución del producto, que se aceptará a cambio únicamente en el embalaje original, intacto y completo. Ningún producto se podrá reemplazar sin una autorización previa por escrito de Arcansas Profili s.r.l. Esta garantía sustituye a las garantías y responsabilidades previstas por la ley y excluye cualquier otra responsabilidad de Arcansas Profili s.r.l en cualquier caso que se derive de los productos vendidos, excepto en caso de intención y negligencia grave.

Reserva de propiedad:

Los productos son propiedad de Arcansas Profili s.r.l hasta que el comprador los pague en su totalidad. El impago, aunque sea parcial, da a Arcansas Profili s.r.l el derecho de recuperar los bienes suministrados, aunque estén almacenados con terceros.

Propiedad industrial e intelectual:

Los signos distintivos, las fotografías de los productos de Arcansas Profili s.r.l y/o las tecnologías de producción y comerciales no se utilizarán o revelarán sin el permiso previo por escrito de Arcansas Profili s.r.l.

Privacidad:

Los datos personales y fiscales adquiridos directamente y/o a través de terceros por Arcansas Profili s.r.l (Località Cerbara, 61030 Terre Roveresche PU), el controlador de datos, se utilizan para los requisitos contractuales y legales, así como para permitir una gestión eficaz de las relaciones comerciales. Dichos datos se podrán comunicar en Italia y/o en el extranjero a la red de agentes de Arcansas Profili s.r.l, empresas de factoring, instituciones de crédito, empresas de cobro de deudas, compañías de seguros de crédito, empresas de información comercial, profesionales y consultores, transportistas.

Jurisdicción competente:

Para cualquier controversia que surja en relación con las condiciones comerciales y/o las órdenes conexas, el tribunal de Pesaro tendrá jurisdicción exclusiva.





ARCANSAS s.r.l.

Via Cerbara, s.n. - località Piagge 61038 Terre Roveresche (PU) - ITALY
tel. +39 0721 891989 | fax +39 0721 891980 | mail info@arcansas.it

www.arcansas.it



arcansas srl